

SHOP HOLIDAY GIFT GUIDE | **VISIT** THE LONE STAR STATE | **BEHOLD** SCENIC HIGHWAY 30A

I ♥ RVing

2025

THE NEW RVS ARE HERE!

EXPLORE **12** OF THE
HOTTEST NEW MODELS

+Go Inside

Complete Guide to
Discovering the
Oregon Coast



HOLIDAY ISSUE 2024

@IHEARTRVING  
IHEARTRVING.COM



Holiday Issue

VOLUME 4 / ISSUE 5 / HOLIDAY 2024

JUMP TO YOUR FAVORITE SECTION—JUST CLICK!



04 Mirror Check

A Brief Look at the RV News and Community

Catch up on the RV news, events, and people, try out a new cozy winter playlist, and see what type of winter adventure suits you.



21 Road Abode

Improving Life on the Go

Festive recipes to celebrate the holidays—RV style. Chasing off the Chill to extend your RV season. Plus, easy band exercises to stay fit on and off the road.



32 Top Level

RV Tech and Tradecraft

Exclusive first-look at 12 brand-new 2025 models covering every need and budget.



45 Edge of the Map

From the Highway to the Campground

Explore the Oregon coast and plan your next getaway on Highway 30A in Florida.

59 RVX

Camping, Adventure, and the RV Experience

Find the perfect gift for the RVer on your list with our holiday gift guide.

66 Fireside

Camping, Adventure, and the RV Experience

Celebrating RV connections.

I♥RVing

I HEART RVING

managing editor | **Sue Mosebar**
design director | **Brian Harvat**

sales & partnerships director | **Laurie Zak**
(laurie@iheartrving.com)

Please contact us to advertise with I Heart RVing

video & social producer | **Nate Kennedy**
social promoter | **Craig Mitchell**
email manager | **Jessica Jiron**
digital marketing specialist | **Larry Norris**
developers | **Ralph Aroljo, Spencer Olive**
intern | **Lilly Petsolt**

I HEART RVING LLC
cofounder | **David Petsolt**
cofounder | **Adam Acosta**

**THANK YOU FOR JOINING US AT THE
I HEART RVING GLOBAL CAMPGROUND.**

**PACK IT IN, PACK IT OUT
EXTINGUISH ALL FIRES**

**SORRY FOR WHAT I SAID WHEN I
WAS TRYING TO PARK THE RV**

FINE PRINT/DISCLAIMERS

Copyright © 2024 by I Heart RVing, LLC

Published by I Heart RVing, LLC. I Heart RVing Magazine was founded in 2021 by a crazy bunch of dreamers, story makers, and idea tree shakers who just want to watch the world read.

I Heart RVing makes every effort to provide information that is informative and practical. The publisher, editor, and writers are not responsible for any adverse outcomes or consequences resulting from the use of suggestions or products that appear in this magazine. The acceptance of advertising in this publication does not constitute or imply endorsement by I Heart RVing, LLC (including parent companies, contributors, affiliates or partners) of any advertised product or service. I Heart RVing accepts no responsibility for claims made in advertisements in this publication.

For all subscription updates and inquiries, go to IHeartRVing.com and submit a Contact form with your details. To subscribe to the magazine, visit IHeartRVing.com/subscribe. To submit a story idea, please contact editorial@IHeartRVing.com.

Happy Holidays!

Dear Fellow RVers,

The holiday season brings much joy, but it can also feel overwhelming. From rushing between events to searching for the perfect gifts for loved ones to juggling multiple family gatherings to navigating a barrage of notifications—everything from must-see sales to group chats... it can be a lot. In contrast, the longer nights, shorter days, cooler weather, and sometimes icy roads naturally nudge us to want to slow down and recharge.

Fortunately, the season offers opportunities to both reconnect with others and turn inward. One of the best ways to embrace this is by turning off our devices and lighting a cozy fire. Instead of searching for something to stream, why not spend an evening watching flames flicker?

“Fire TV,” as I like to call it, is perfect for quieting the mind. The mesmerizing dance of flames invites introspection and a calming stillness, even (or especially) amidst the holiday hustle and bustle.

Fireside chats are another gift of the season. They encourage deeper, more meaningful conversations—free from digital

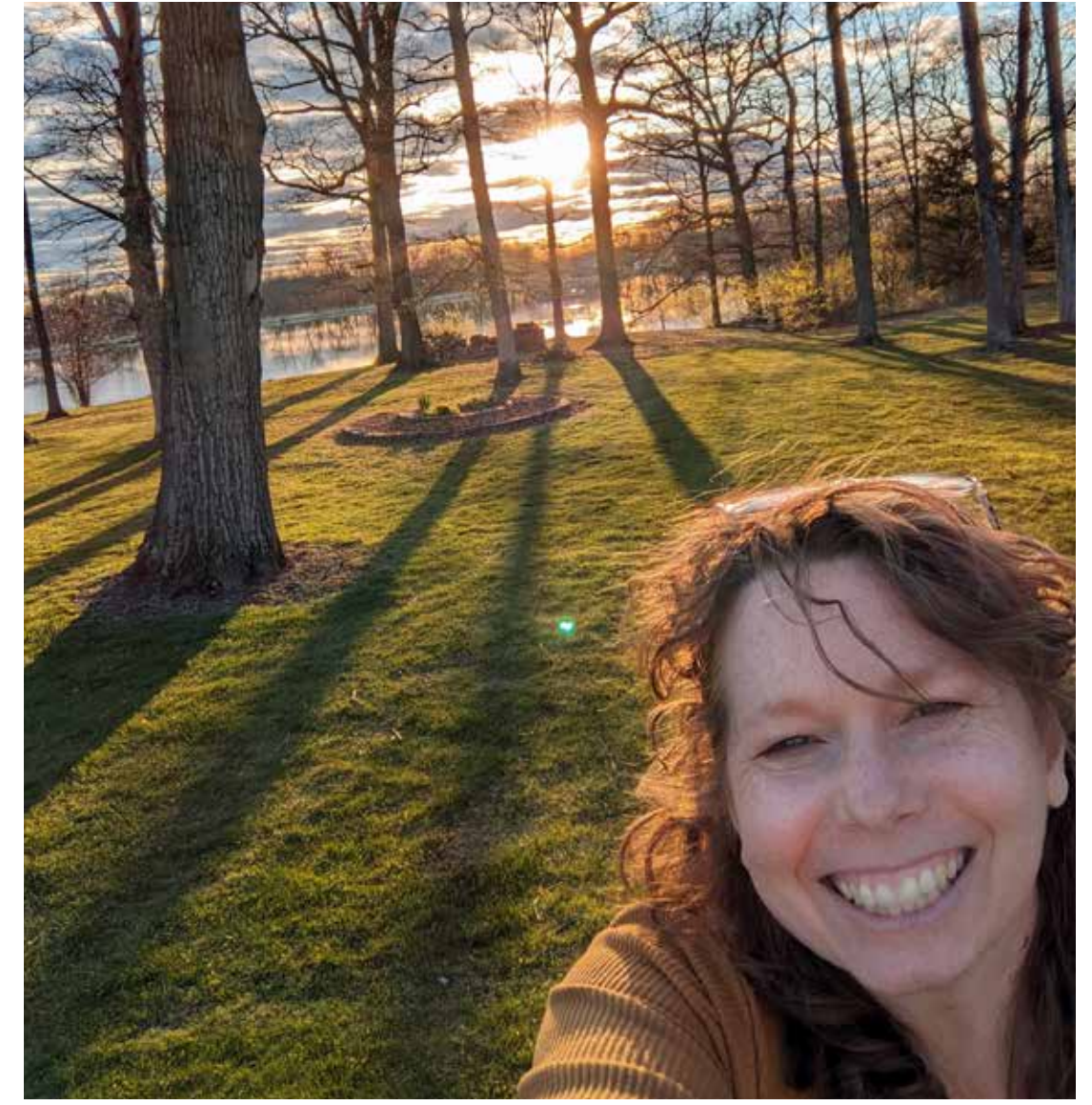

distractions and interruptions. A warm, inviting fire naturally draws people in, sparking storytelling, laughter, and shared moments of holidays past.

As RVers, we're especially fortunate as we can often enjoy this experience wherever we roam. Whether parked in a serene setting, surrounded by nature, or close to friends and family, RVing allows us to create these moments with greater ease. Many RV parks and campgrounds offer firepits, making it simple to turn “fire TV” into a family tradition—not just during the holidays but throughout the year.

Here's to slowing down, savoring all the joy of the season, and fully embracing these moments that matter most. After all, the holiday season is about the gift of presence, not just presents.

Wishing you a happy, warm, and safe holiday season,

Sue Mosebar

Sue Mosebar



SPORTTREK

TOURING EDITION

Designed for Campers
by Campers!



Cherishing Every Journey Together

At Venture RV, we believe in the magic of family moments. Our mission is to connect loved ones with the beauty of the outdoors, creating cherished memories along the way. Our dedication to quality and craftsmanship means we take care of the details, so you can simply enjoy time together.

Discover our SportTrek Touring Edition Luxury Fifth Wheels and Travel Trailers.



(888) 988-8440



Learn more about our lineup
venture-rv.com

IN THE NEWS



Banishing Boring Beige (or Brown)

RV interior décor has been fairly standard for decades, with shades of beige or brown being the most common (and sometimes only) options. Sure, the neutral palettes were tasteful, but they often lacked much in terms of personality, and going from one RV to the next felt pretty much the same.

One of the most exciting RV trends for 2025 is the end of just boring brown options. Interior designers have been hard at work to create RVs that have more of an upscale condo feel. Yes, you can still find neutral color schemes that appeal to a wide audience,

but in 2025, expect more fresh (and often fun) colors, upscale lighting, and modern, interesting patterns.

We can also look forward to changing layouts that, for example, are more pet-friendly or provide integrated office spaces for remote workers or those who just need to check in with the office from time to time from the road.

Other exciting new trends and upgrades expected in the coming year include:

- Solar power systems
- Upgraded appliances (like onboard air fryers, convection microwaves, and smart TVs)

- And touchscreen control panels for everything from climate control to awnings to window shades and slide outs.

All these upgrades are designed to provide a more pleasant experience for the modern RVer.

Keeping America on the Road... and Working

The number of U.S. jobs due to the RV industry.

680K

Upcoming RV Events

South Texas RV Super Sale

Dates: January 2 - 5, 2025

Location: Freeman Coliseum Expo Hall, San Antonio, TX

southtexasrvsupersale.com

Kick off the new year with one of Texas's largest RV shows. The South Texas RV Super Sale offers unbeatable deals on a wide selection of RVs, accessories, and outdoor gear.

Greenville RV Show

Dates: January 3 - 5, 2025

Location: Greenville Convention Center, Greenville, SC

greenvillervshow.com

Explore the latest RV models and outdoor equipment at the Greenville RV Show, the perfect stop for families ready to plan their next big adventure.

Indy RV Expo

Dates: January 4 - 5 and 8 - 12, 2025

Location: Indiana State



Fairgrounds, Indianapolis, IN
indyrvexpo.com

This long-standing event brings the best of the RV world to Indianapolis. With hundreds of RVs on display, it's a must-see for anyone looking to start the year with new travel plans.

Valley RV and Camping Show

Dates: January 9 - 12, 2025

Location: Century Center, South Bend, IN

rvshows.org

From campervans to luxury motorhomes, the Valley RV and Camping Show features a range of RVs to suit all budgets, plus expert

advice on camping and travel accessories.

Grand Rapids Camper, Travel & RV Show

Dates: January 16 - 19, 2025

Location: DeVos Place, Grand Rapids, MI

showspan.com

Discover hundreds of RVs, trailers, and motorhomes from regional dealers, along with travel destinations, campsites, and more in the heart of Michigan.

Complete list of RV Events

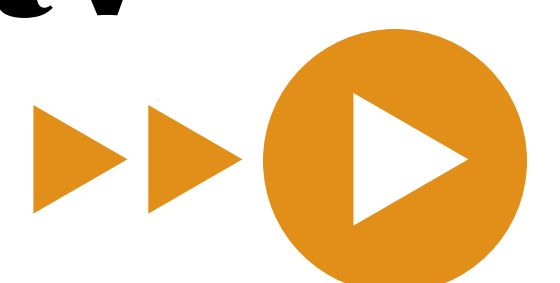



HOLIDAY 2024 PLAYLIST

RELAX WITH SOME COZY, COOL-WEATHER VIBES (SANS THE USUAL CHRISTMAS TUNES), PERFECT FOR WARMING UP BY THE FIRE OR UNWINDING AFTER A DAY ON THE ROAD. THIS PEACEFUL MIX OF MOSTLY ATMOSPHERIC INDIE TRACKS PROVIDES A CHILL BACKDROP PERFECT FOR LONG WINTER EVENINGS.

PLAY ON SPOTIFY

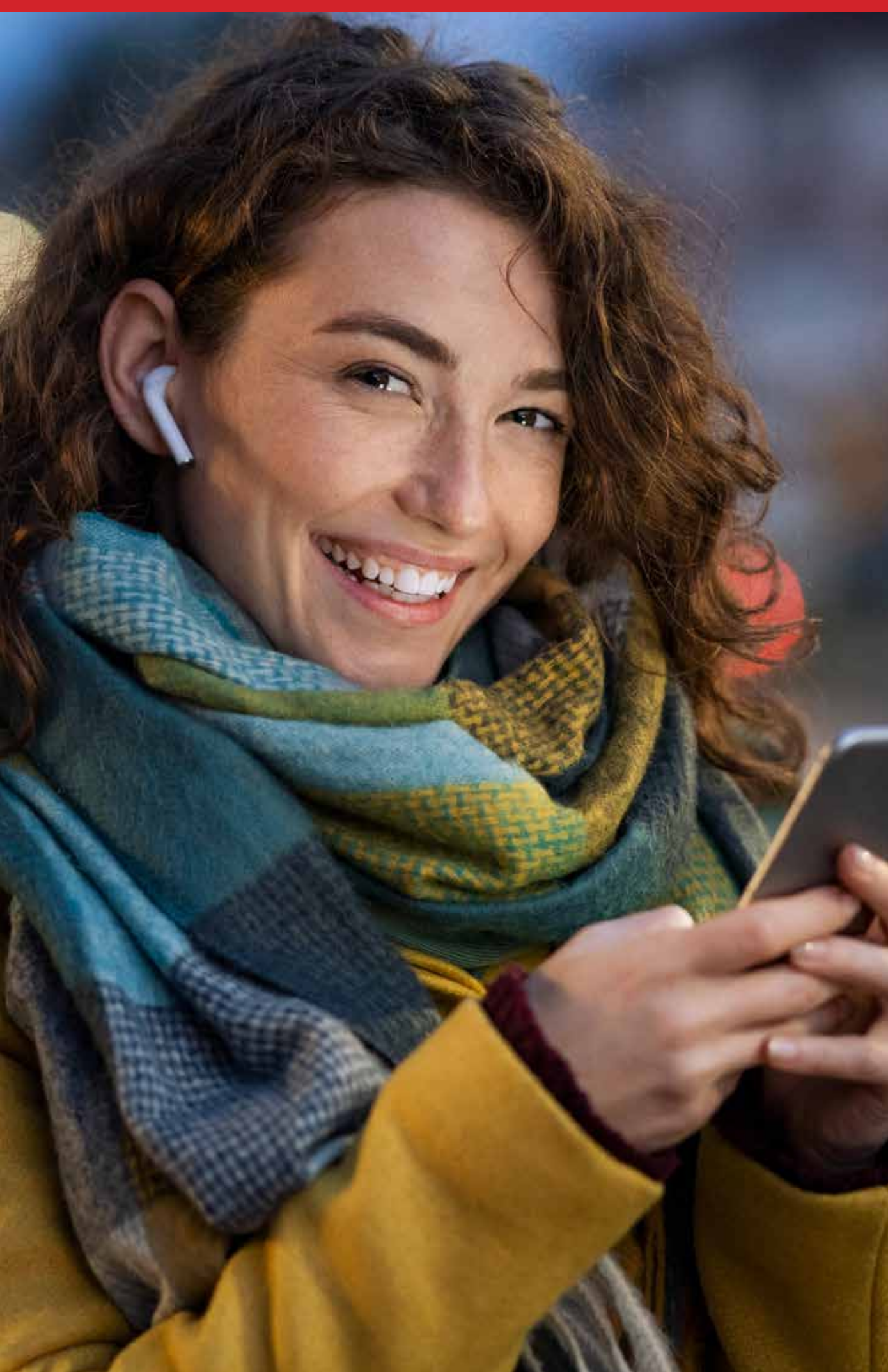

@beerving_america

Why We Heart It – This couple travels the country posting a great VLOG and stopping for an occasional beer. 🍷

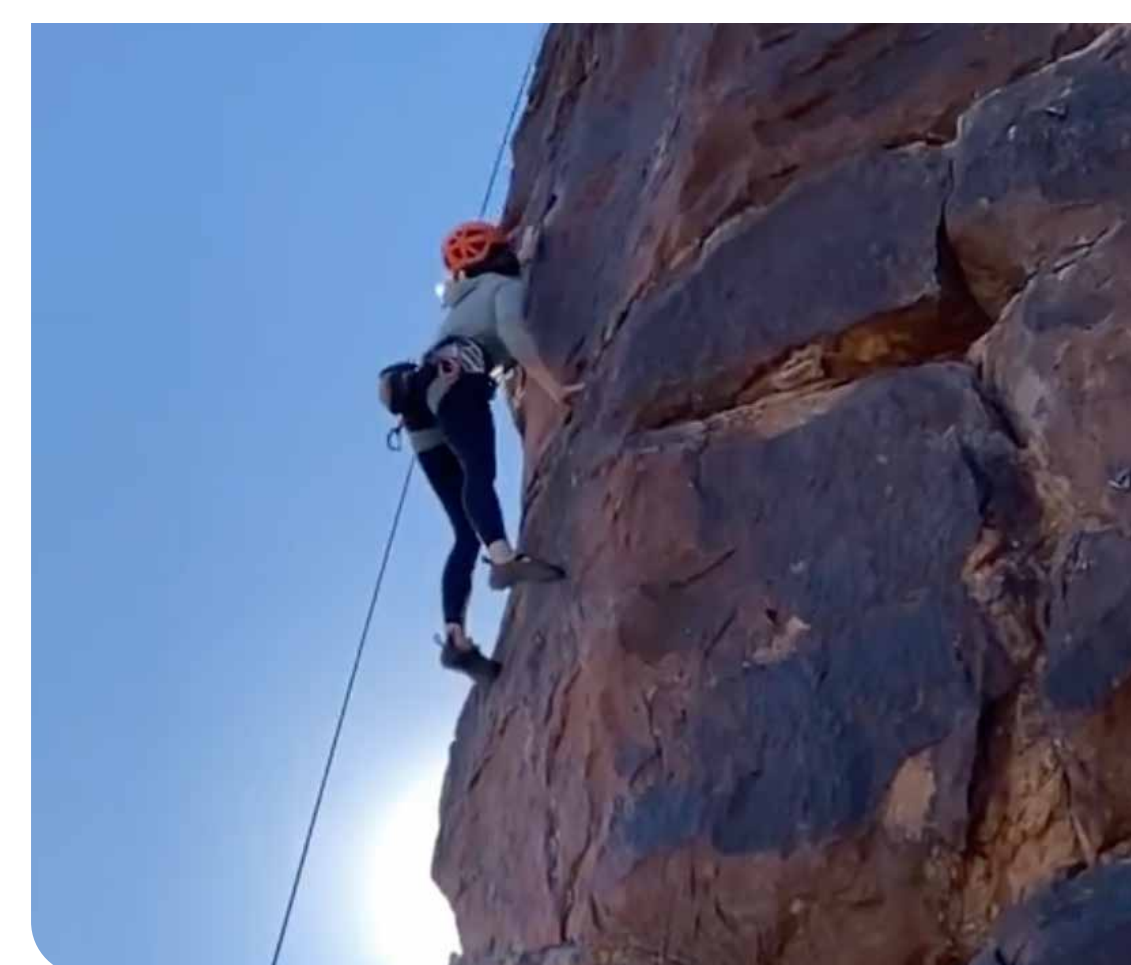

@brightonpeachy

Why We Heart It – Follow this Search and Rescue worker turned mom of 3. Shares great tips, gear recommendations, community, & inspiration for adventure with kids. 😊



RV QUIZ

Need Some Ideas for Your Next Trip?

THIS QUIZ CAN HELP YOU CHOOSE YOUR NEXT ADVENTURE BY DELVING INTO YOUR PREFERENCES DURING THE COLDER MONTHS.

No. 1

What's your ideal winter weather?

- A.** Crisp and clear with a bit of snow
- B.** Full-on winter wonderland, surrounded by snow
- C.** Cold enough to see your breath, but not too snowy or icy
- D.** Make it sunny and mild, with just a hint of chill

No. 2

How do you like to spend your time outdoors in the winter?

- A.** Hiking or snowshoeing on snow-packed trails
- B.** Pow Day! Spending the day on the slopes skiing or snowboarding
- C.** Ice fishing, snowmobiling, or other rugged outdoor activities
- D.** Relaxing by the fire after a scenic drive through winter landscapes

No. 3

What's your preferred type of RV camping spot?

- A.** A quiet, secluded campground in the woods
- B.** A mountain resort with plenty of winter activities nearby
- C.** Off-the-grid, deep in nature—far away from the crowds
- D.** A cozy spot near a charming town for shopping and dining

No. 4

Which activity sounds the most fun for a winter's night?

- A.** Stargazing on a clear, cool evening
- B.** Après-ski at a mountain lodge sipping on hot chocolate, mulled wine, or an

old-fashioned

- C.** Gathering with close friends or family around a campfire
- D.** Bundling up and wandering through a festive, twinkling village

No. 5

What's your ideal way to stay warm?

- A.** Bundling up with layers of wool and a high-tech thermal jacket
- B.** Sitting in front of a roaring fireplace with a warm drink after a day on the slopes
- C.** Enjoying active adventures that keep you moving and warm
- D.** Cozy and warm in a well-heated RV with some soft blankets and a hot cup of tea

No. 6

What's your comfort food when the temperatures drop?

- A.** A hearty stew or chili
- B.** Anything that comes with hot cocoa or cider
- C.** Anything cooked over a campfire
- D.** A delicious take-out dinner from a favorite local café or restaurant

Quiz Results:

Mostly As: The Snowy Explorer

You crave the quiet and beauty of winter landscapes. Your perfect adventure is hiking through snow-covered trails or exploring a National Park where the natural beauty of winter is at its peak.

Mostly Bs: The Mountain Adventurer

You thrive on winter activities! Skiing, snowboarding, and après-ski are your thing, and your ideal winter adventure takes you to a bustling mountain resort full of energy and excitement.

Mostly Cs: The Wilderness Survivor

You're not afraid to brave the cold and get off the beaten path. Your perfect winter adventure involves rugged outdoor activities like snowshoeing or camping in the wilderness, where you can connect with nature in its raw winter form.

Mostly Ds: The Cozy Wanderer

Your ideal adventure involves scenic drives through snow-dusted towns, enjoying local shops and cafes, and staying warm and cozy in your RV.

Now that you've taken the time to reflect and discover your ultimate cold-weather adventure, it's time to make a plan, pack up your gear, map your route, and embrace the magic of the season.

American

VANTAGE POINTS OF AMERICAN BEAUTY

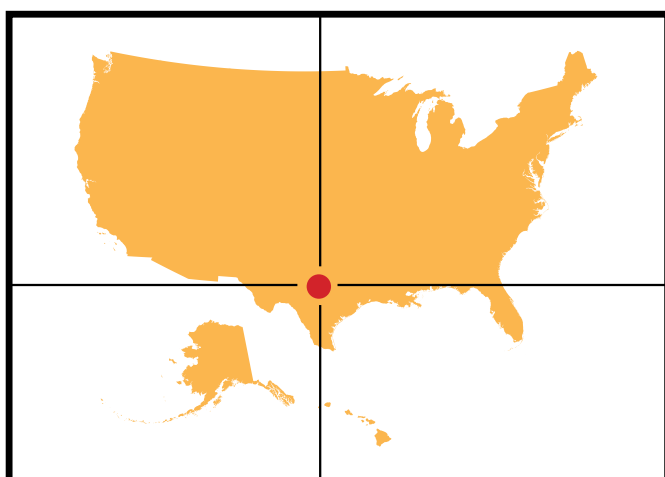

▶ 48° 30' N, 92° 53' W

▶ TEXAS

▶ WWW.TEXAS.GOV

Vista



AS THE TEMPERATURES BEGIN TO DIP, many RVers head south. And one of the most popular destinations is Texas. The second largest state in the U.S. comes with a bold personality, vast landscapes, diverse ecosystems, and vibrant cities, creating an experience as big as the state itself. You can find something for every RV enthusiast!

Because it's a jungle out there.

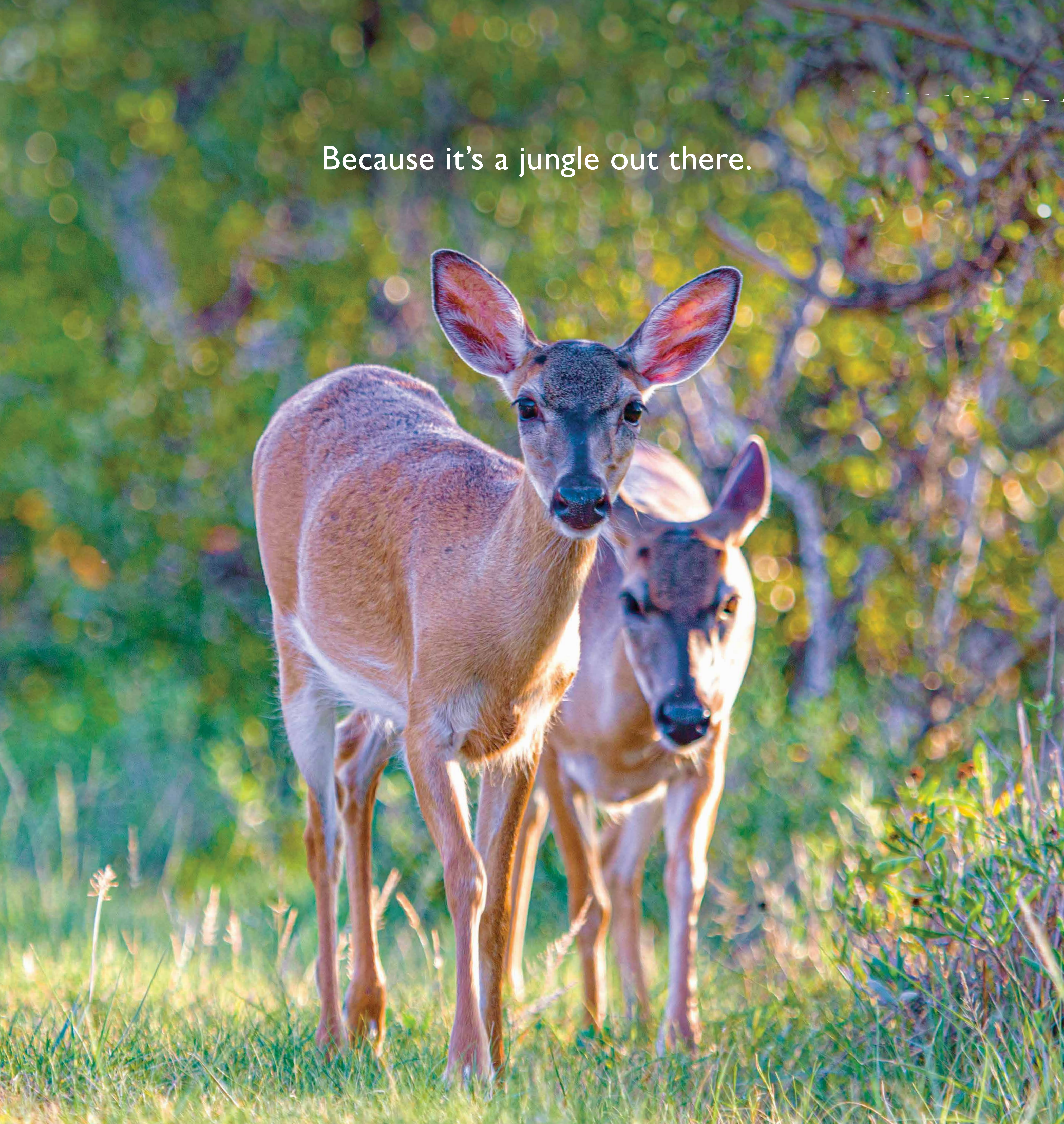

Florida's Lower Keys are home to two wildlife refuges, epic ocean views, miles of unspoiled wilderness and an array of outdoor accommodations ranging from rustic campsites to lavish RV parks. From Big Pine to Stock Island, you'll never run out of extraordinary places to step off the treadmill and watch the world go by.

fla-keys.com/lowerkeys 1.800.872.3722





South Padre Island Birding and Nature Center

Nature lovers will find countless migratory birds with walkable boardwalks and observation towers to see myriad species, including egrets and herons, up close. Avid birders, butterfly enthusiasts, and those just looking for a peaceful walk will find this area a lovely place to reconnect with nature and her beauty and abundance.





South Padre Island Barrier Dunes & Laguna Madre

Experience the magic of sand dunes as they meet up with the Gulf for stunning coastal vistas and pristine stretches of sandy shores. Laguna Madres is one of only six hypersaline lagoons in the world, making it an excellent area for fishing, kayaking, paddleboarding, and the many wonders of Texas' coast.





Rio Grande River in Big Bend National Park

This river serves as the lifeblood of the desert. As you journey along the river, you'll encounter steep canyons, diverse wildlife, and breathtaking views. Pick your adventure between the peace of the desert or the thrill of river rapids. The park's rugged landscapes invite RVers to embrace adventure, from hiking in the Chisos Mountains to kayaking along the winding Rio Grande. All with jaw-dropping views in the background.





Balanced Rock on Grapevine Hills Trail

RV explorers with a fondness for hiking and geology will fall in love with this fascinating area. With its unusual shape and panoramic views of Big Bend, the iconic rock formation of Balanced Rock at the end of the moderate, 1.9-mile out-and-back hike is well worth the effort. It's an ideal spot to take in the wild, rugged beauty of Texas' mountainous desert regions. But don't stop here. Big Bend National Park is made for hikers and offers everything from short, easy strolls to challenging mountain treks.





Scenic Guadalupe Mountains National Park

Some of the best hiking in Texas can be found in this national park due to its striking desert landscapes and variety of flora and fauna. The park's scenic routes lead to impressive sights, such as the towering El Capitan. In addition, you can find wonderful camping options for your RV to soak up the expansive night skies. Hike through the canyons, experience ancient fossils, and enjoy some of the highest peaks in the area.





Austin: Where Nature and Culture Meet

This exciting, RV-friendly city is known for its lively music, eclectic neighborhoods, and outdoor beauty. Immerse yourself in the city's unique culture while savoring some delicious Texas BBQ, sipping on a quality cocktail or craft beer, and exploring a diverse live music scene along Sixth Street.





Sculpture Falls via Barton Creek Greenbelt

For a refreshing break, head to Sculpture Falls in Austin. Nestled within the Barton Creek Greenbelt, this natural swimming hole is a local favorite on hot days due to its clear water and surrounding greenery. Accessible by a scenic trail, it's a peaceful spot to unwind and recharge after a day of travel or exploring Austin's energetic vibe.





The rolling hills just outside of Austin come alive at sunset.

Terlingua is a ghost town near Big Bend that offers Old West charm, local art, and a taste of Texas' rugged past.

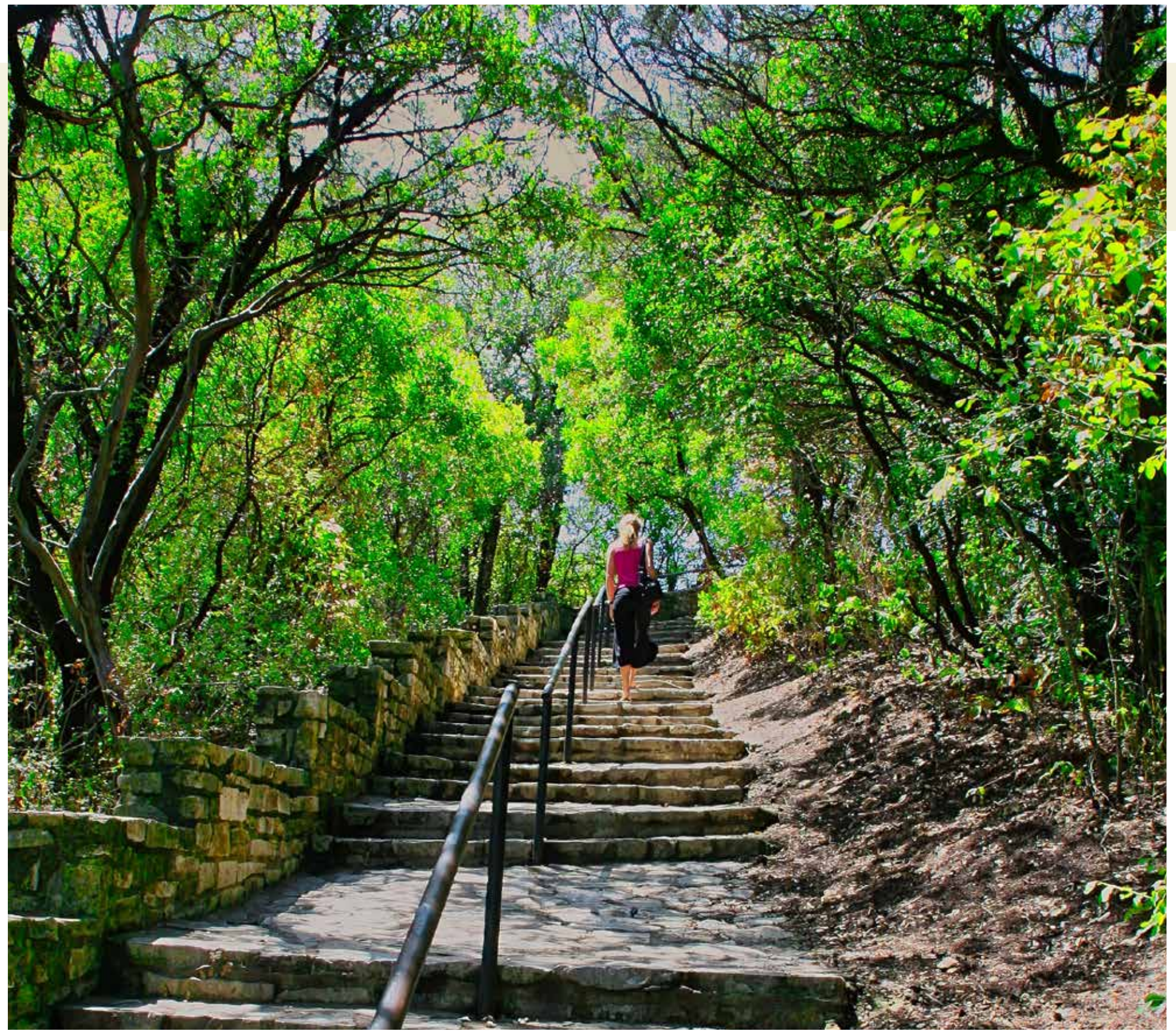



Beyond birdwatching, South Padre Island's beaches are made for splashing around, jet skiing, or simply soaking up the sun.



As you travel throughout Texas, keep an eye out for roadrunners darting along the roadside. You'll also be able to spot iconic agave plants standing proudly, reminding us of Texas' wild side.



Road Abode

IMPROVING LIFE ON THE GO

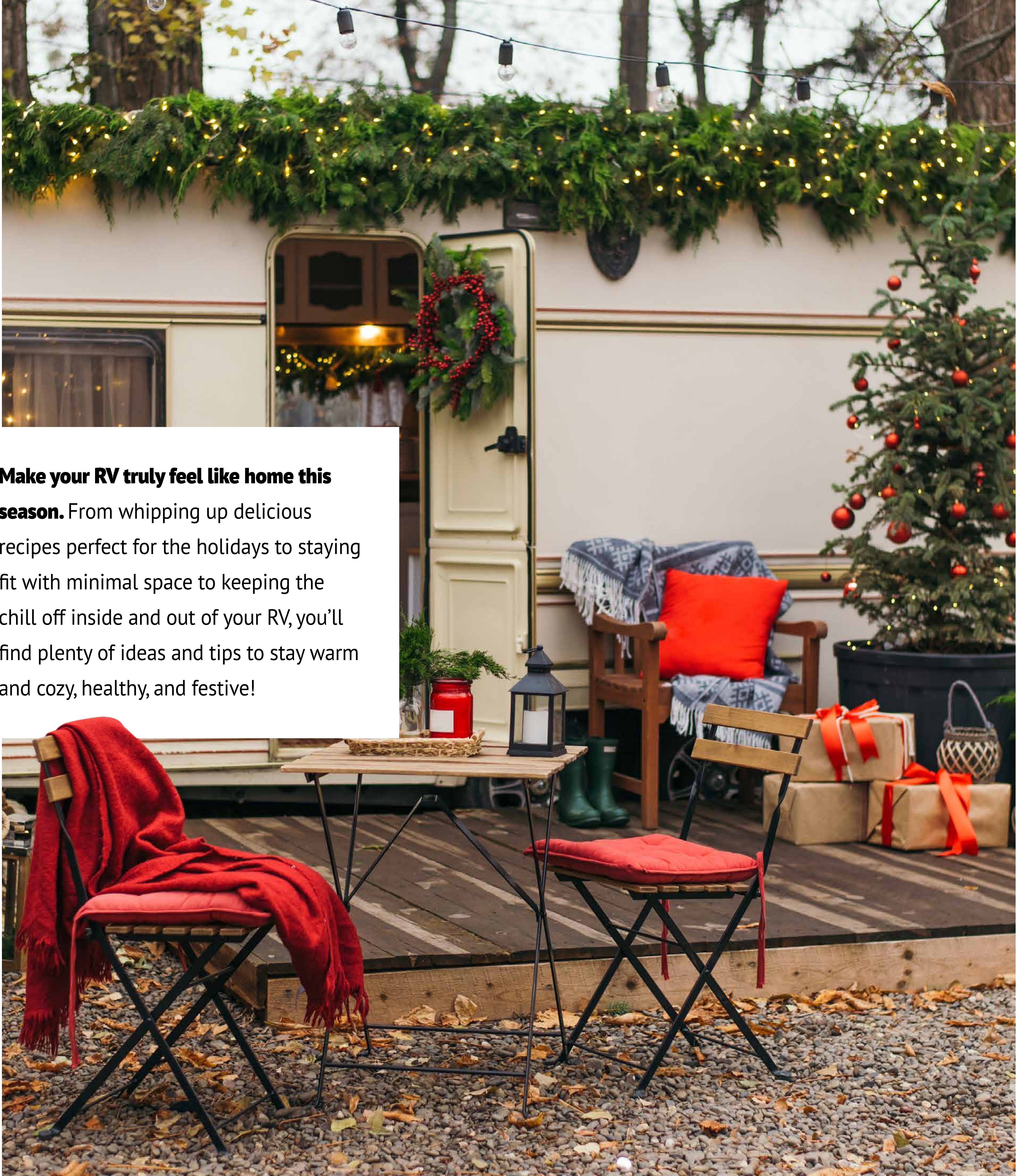

Make your RV truly feel like home this season. From whipping up delicious recipes perfect for the holidays to staying fit with minimal space to keeping the chill off inside and out of your RV, you'll find plenty of ideas and tips to stay warm and cozy, healthy, and festive!

OTHERWORLDLY NOISE REDUCTION

The Onan QG 4000i

Enjoy epic peace and quiet with the Onan QG 4000i. With over 100 years of generator experience, Cummins brings you one of the quietest RV generators today. Its EFI variable-speed engine automatically adjusts speed to match the power needed which greatly reduces noise and vibration— even when you're driving between destinations. Discover the generator that everybody will be talking about but few will hear.



Learn more at cummins.com/generators/onan-qg-4000i



Festive & Flavorful

There's no bad time to hit the open road in your RV, and that includes over the holidays! You can visit family and loved ones without rushing to your gate through crowded airports. Or seek warmer weather and expansive views for a quiet holiday in nature. Or head up to the high country and stay cozy and warm surrounded by a snowy winter wonderland. No matter what your idea of a perfect holiday is, RVing provides a unique way to celebrate.

With a few simple decorations—think battery-powered string lights, mini ornaments, or a tabletop tree or holiday wreath—your RV can sparkle with the spirit of the season. And if the festive flavors are what bring the holidays to life for you, these simple recipes provide comfort and warmth and are perfect for sharing.

Holiday Stuffing Muffins

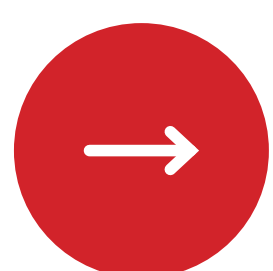

These individual stuffing muffins are so easy to make, even with limited space, and provide the comfort of a home-cooked holiday.

INGREDIENTS:

4 cups cubed bread (day-old works best)

1 cup cooked sausage (optional)

1/2 cup dried cranberries

1 stalk celery, chopped

1 small onion, chopped

1 tsp fresh rosemary, chopped (or 1/2 tsp dried)

1 tsp fresh sage, chopped (or 1/2 tsp dried)

Salt and pepper to taste

1 egg, beaten

1 cup chicken or vegetable broth

DIRECTIONS:

1. Preheat your RV oven to 350° F.
2. In a large bowl, combine the bread, sausage, cranberries, celery, onion, herbs, salt, and pepper.
3. Add the beaten egg and broth, stirring until the bread is moistened.
4. Grease a muffin tin. Then, spoon the stuffing mixture into each cup until about half full.
5. Bake for 20 - 25 minutes or until golden brown.
6. Serve warm and enjoy!



Slow Cooker Mulled Cider

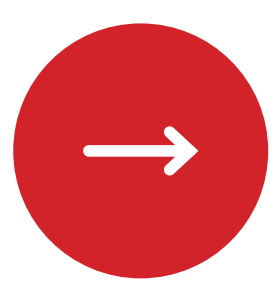

The comforting aroma of spiced cider will make your entire RV smell like the holidays. Plus, it's the perfect drink to warm up on chilly days with plenty to share the holiday spirit with others.

INGREDIENTS:

1 gallon apple cider

3 cinnamon sticks

1 tsp whole cloves

1 orange, sliced

1 Tbsp honey or maple syrup (optional for added sweetness)

DIRECTIONS:

1. Pour the apple cider into a slow cooker.
2. Add cinnamon sticks, cloves, and orange slices.
3. Set to low heat and let simmer for three to four hours, filling your RV with its festive aroma.
4. Serve in mugs, garnished with a cinnamon stick or orange slice if desired. Add some fun, festive music or your favorite holiday movie to delight all of your senses as you sip this traditional beverage.

Traveling over the holidays doesn't mean you have to miss out on the magic of the season. In fact, it may be the best way to embrace it. With some simple decorations and festive recipes, you can bring a little holiday spirit wherever you park.

GETTING FIT WITH THE BAND



IF YOU'VE HEARD IT ONCE, YOU'VE

HEARD IT A MILLION TIMES:

staying active is essential for health, no matter where the road takes you. Regular physical activity helps maintain strength

and stamina and increases energy. It can also help you live longer and add more life to your years. But if you're spending extensive time in an RV, staying fit can be a challenge.

Sure, you can join a national chain of gyms to make use of their facilities (where available). But depending on where you're staying, you may not have easy (or any) access when it's time to exercise. That's where resistance bands fit in. Literally.

BIG BENEFITS IN A SMALL PACKAGE

Resistance bands are lightweight, compact, and highly versatile, which makes them a perfect tool for travel-friendly fitness. Plus, they can be used to target every muscle group, providing a full-body workout.

Some research even suggests resistance bands can be as effective as other equipment for building strength. For instance, a study in the *Journal of Strength and Conditioning Research* found resistance bands provided similar strength gains to traditional weightlifting to improve muscle performance, endurance, and mobility. An ideal fit for RVers who want to stay healthy and relieve the stiffness and discomfort that so often come with long hours behind the wheel.

Whether you're on the road for a fun family vacay or life on the road is your full-time lifestyle, this quick, simple workout can be done anywhere, anytime.

20-MINUTE BAND WORKOUT

Caveat: Before you start, make sure your bands are in good shape and don't show any signs of fraying or tears, which can cause the band to break and could snap back and hurt you. If you are attaching the bands to anything, such as a door or another part of your RV, make sure it is firmly in place and the object is sturdy, again to prevent injury.

Okay. Ready? Start with a short (3- to 10-minute) warmup, such as a walk around the campground, some dynamic stretching, arms swings, shoulder rolls, and or marching in place. Then, shoot for 10 to 12 repetitions of each of the exercises below.

SQUATS

Targeting your legs and butt



Place the band just above your knees, and stand with your feet about hip-width apart. Squat as if you're sitting in a chair, keeping the band tight by pressing your legs into the band on the outside of your thighs. Return to standing and push the hips forward. Repeat.

SEATED ROWS

Targeting the back, shoulders, and arms

Sit down on the floor with your legs straight in front of you. Anchor the band around your feet or attach it to a sturdy, unmovable object. Holding onto each side of the band, relax your shoulders down, and pull the band toward you as if rowing while keeping your elbows close to your sides.

GLUTE BRIDGES

Targeting the glutes and hamstrings

Place the band around your thighs and lie on your back with your knees bent and your feet flat on the floor. Push through your heels as you lift your hips up into a bridge position, squeezing your glutes at the top. Slowly lower down and repeat.



STANDING SHOULDER PRESS

Targeting the shoulders and arms

Stand on the band, holding a handle in each hand. Then press the band overhead, lower it slowly, and repeat.

DEADLIFTS

Targeting the lower back, glutes, and hamstrings

Stand on the band with a handle in each hand. Bend the hips, keeping your back flat with only a slight bend in the knees. Then, return to standing and repeat.

KNEELING BICEPS CURLS

Targeting the biceps (front of the arms)



Kneeling on the band, with a handle in each hand and your palms facing forward, curling the handles toward your shoulders, squeezing your biceps at the top of the motion.

TRICEPS EXTENSIONS

Targeting the triceps (back of the arms)

Anchor the band overhead (such as in a tightly closed and locked door). Hold the handles with your elbows bent at a 90-degree angle. Extend your arms downward until fully straightened, squeezing your triceps at the bottom.

Aim for two to three rounds to work the entire body in 20 minutes. Then, spend another 3 to 5 minutes to cool down with some gentle stretches to release any remaining tension.

No matter where your RV adventures take you, it's easy to maintain a fitness routine with a simple set of bands of varying resistance and a little time. These exercises are designed to keep you strong, mobile, and ready for your next adventure. Whether you're parked at a scenic campsite or just need an energizing break from the drive, you can get a quick, effective workout. ❤️

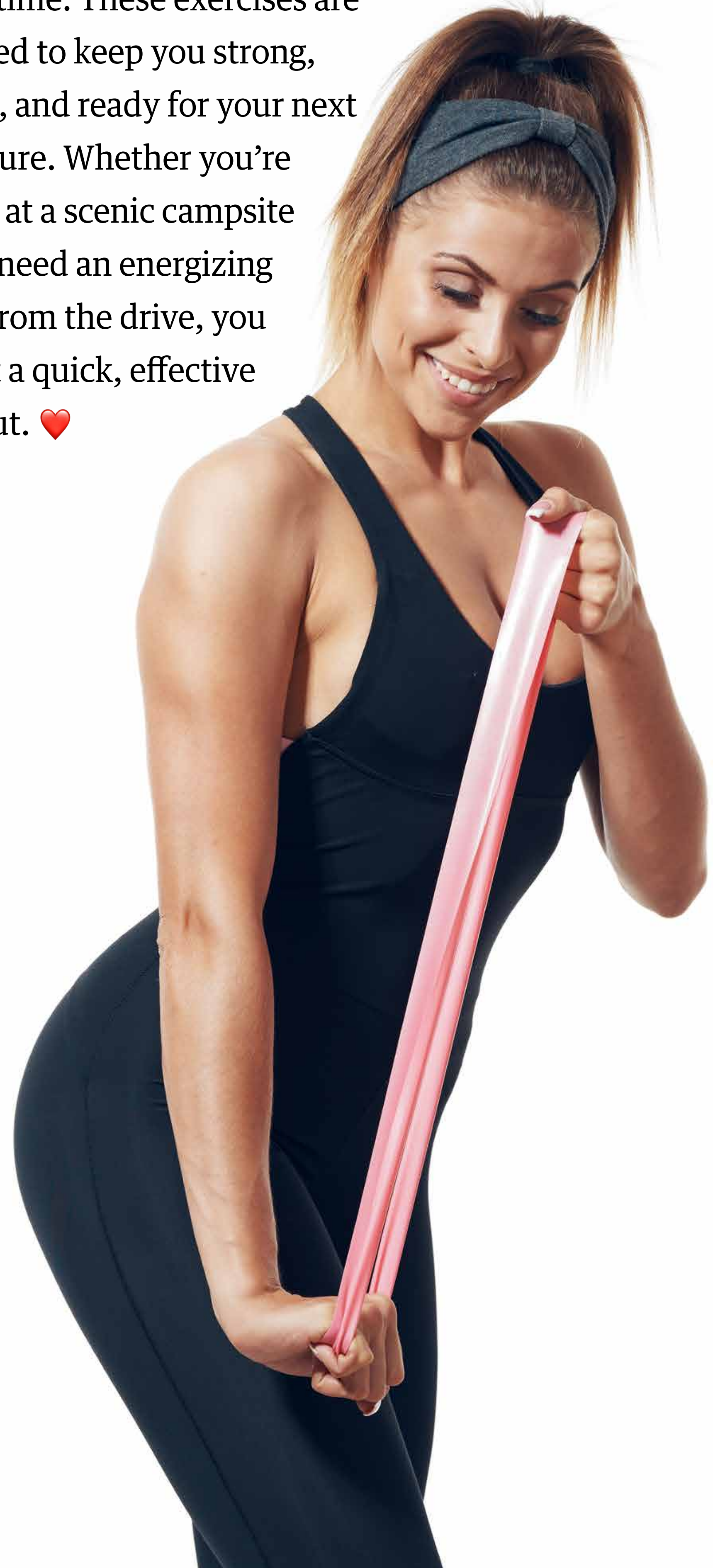

CHASE OFF THE

ROAD

TO

THE

WHEELS

OF

FALL

IS

If you're like many Americans, fall is your favorite season. In fact, 41% of U.S. adults say fall is the best (compared to 11% who picked winter and 24% who chose spring or summer). And many RVers are falling in love with hitting the road during this spectacular season. Not only are the leaves putting on fabulous shows across the country, but as the air turns crisp, the campgrounds tend to calm.

That said, it can be a bit of a challenge to chase off the chill and extend the time you can enjoy being outdoors—especially as the sun drops earlier. Fortunately, a few simple tricks can help you extend your outdoor hours. All while staying cozy and warm and enjoying everything you love about RVing.

SO, WHAT ARE THE BEST WAYS TO KEEP THE COLD AT BAY?

Dressing in layers isn't just about being fashionable. It's one of the best ways to stay comfortable and cozy when the weather gets cooler. Layering allows you to easily regulate your body temperature by adding or removing clothing. That allows you to keep the body heat in and the cold air out, without overheating during the day or when you're more active.

In general, you'll want to start with a moisture-wicking base

layer that's snug and able to wick away moisture. That way, even if you sweat, your skin will remain dry, which is essential for staying warm. While synthetic materials, such as polyester, can be effective and are often advertised for these properties, natural fibers like merino wool are often preferred. That's because wool is naturally moisture-wicking, breathable, and insulating—even when wet. In addition, unlike synthetic fibers, wool resists odors, which is important when your wardrobe is limited and you wear the same layers repeatedly.

Next up is an insulating middle layer to keep you warm and cozy. Choose a fleece jacket, down vest, or wool sweater to keep the heat close to your body as the weather gets cool. Again, natural fibers tend to have an edge. Wool not only insulates well but it also holds up over time. Plus, it's a sustainable choice. And it's a great option for RVers looking for durability and longevity in their clothing.

Finally, add a lightweight, easily portable wind- or waterproof outer layer when needed. Especially if wind, rain, or snow is in the forecast, this layer is essential for keeping you dry and warm.

LAYER UP



CREATE A

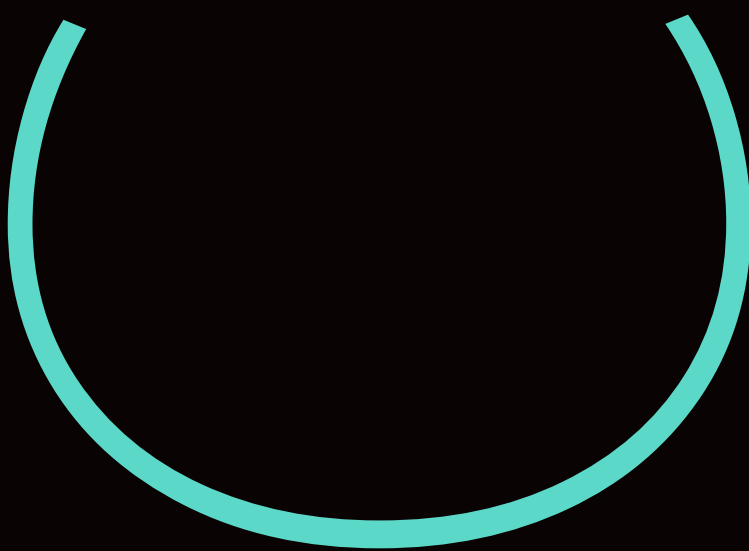
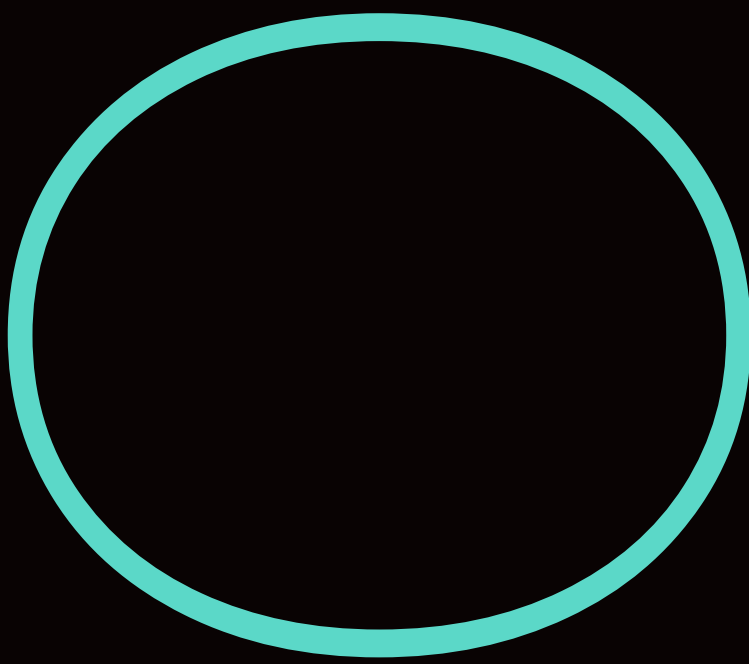

OUTDOOR SPACE



Even when the temperatures drop, that doesn't mean you necessarily have to retreat inside your RV. The key is to design an outdoor living space that's inviting, protects you from the elements, and provides enough warmth to make crisp, cool nights enjoyable.

That starts with location. Position any outdoor furniture so it's protected under an awning or a pop-up canopy. This can be used to block wind and shelter you from light rain or snow if the weather changes. If the wind is gusty, consider adding additional windbreaks or screens. You may also want to roll out an outdoor rug, which can insulate the ground under you and make the area warmer and more inviting.

You can then add additional heat with a portable firepit or outdoor heater to gather around. Portable propane firepits are becoming popular with RVers as they're easy to transport and you don't have to find firewood. In addition, they can instantly provide warmth. Plus, even if there are fire restrictions, many campsites allow them. However, it's crucial to follow the safety guidelines and keep the firepit

a safe distance from your RV, any flammable objects, and yourself.

Another convenient option is an electric or propane portable heater. These heaters can provide targeted warmth, and many are compact enough to store in your RV when not in use. Remember, however, that these heaters are made only for outdoor use. Proper ventilation is a must to avoid any safety hazards.

Now that you're dressed well and have a heat source to stay warm, it's time to focus on ambiance. Outdoor-safe blankets and throw pillows in your seating area can exponentially increase the coziness factor. Wool and fleece are ideal because they're soft, warm, and durable enough to withstand outdoor conditions.

Finally, add some string lights or lanterns to create a soft, radiant glow around the space so it feels warmer. The added light also helps

you extend your time outside even as the sun sets earlier and earlier.



EXTEND YOUR EVENINGS AND EMBRACE THE



It doesn't take a lot of time or effort to transform your outdoor living space to extend your hours outside as the weather cools. A few slight tweaks can help you create a cozy environment well into fall and early winter. A few layers of clothing, a warming firepit or portable heater, some soft blankets, and glowing lights will help you create an inviting outdoor area so you

can enjoy those peaceful, crisp nights without feeling chilled. All that's left is to pour your favorite warming beverage—whether it's hot cocoa, spiced cider, or herbal tea—and perhaps bring out some comforting snacks.

With these simple tricks, you can savor the beauty of the cooler seasons and extend your RV adventures long after the summer sun has faded. ❤️



TOP
LEVEL



2025 is almost here and the '25 RV models are ready to hit the road. Innovative, exciting changes and upgrades galore. Be the first to see this exclusive first look. Check out the best of the best and imagine yourself behind the wheel.

NEWMAR MOUNTAIN AIRE 4595

The Newmar Mountain Aire is the pinnacle of luxury and sophistication in the world of motorhomes. This stunning vehicle seamlessly combines innovative design with unparalleled comfort, making each journey an extraordinary experience. The Mountain Aire 4595 showcases high-end materials and meticulous craftsmanship, offering spacious living areas, state-of-the-art technology, and premium amenities that redefine traveling in style. The Mountain Aire ensures that every moment is surrounded by the elegance and convenience that discerning travelers deserve.

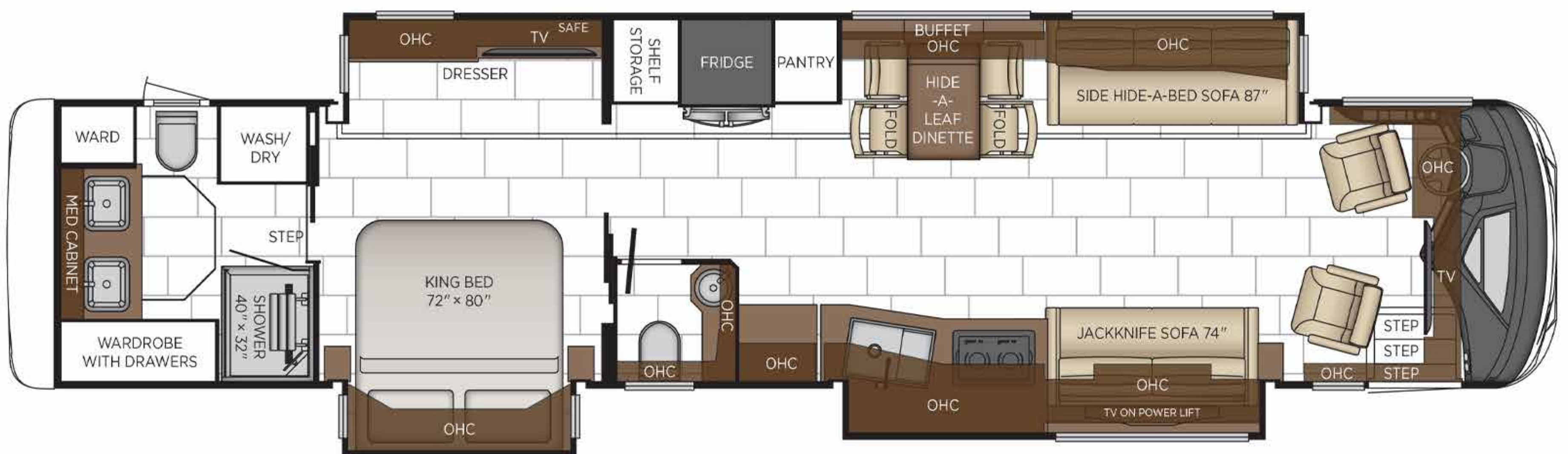

NEWMAR MOUNTAIN AIRE 4595 SPECS

- ▶ ENGINE: 525 HP CUMMINS
- ▶ GCWR: 69,000
- ▶ FRESH/GRAY/BLACK: 105/80/60
- ▶ EXT LENGTH: 44' 10"
- ▶ EXT HEIGHT: 13' 2"
- ▶ EXT WIDTH: 101.5"



→ COACHMAN EURO CROSSOVER

Turn heads with the 2025 Coachman Euro Crossover, a sophisticated blend of modern design and versatile functionality. This innovative RV is engineered for adventure seekers who refuse to compromise on luxury and convenience. With its sleek exterior, aerodynamic shape, and premium materials, the Euro Crossover stands out while enhancing fuel efficiency.

Inside, you'll discover a thoughtfully designed living space that maximizes comfort and utility. The open-concept floor plan features spacious seating areas with plush furnishings.



COACHMAN EURO CROSSOVER 25EU SPECS

- ▶ ENGINE: N/A
- ▶ GCWR: 23,000
- ▶ FRESH/GRAY/BLACK: 50/31/31
- ▶ EXT LENGTH: 28' 4"
- ▶ EXT HEIGHT: 11' 1"
- ▶ EXT WIDTH: 99"



→ RENEGADE RV EXPLORER

Introducing the 2025 Renegade RV Explorer, the ultimate choice for adventure enthusiasts who demand luxury on the road. Built on a robust chassis for off-road capability, this RV features a striking aerodynamic design that enhances both performance and aesthetics.

The luxurious master suite offers a plush bed and an en-suite bathroom with a spacious shower and modern fixtures. Advanced smart technology allows for seamless control of lighting, climate, and entertainment, ensuring you feel at home wherever you are.

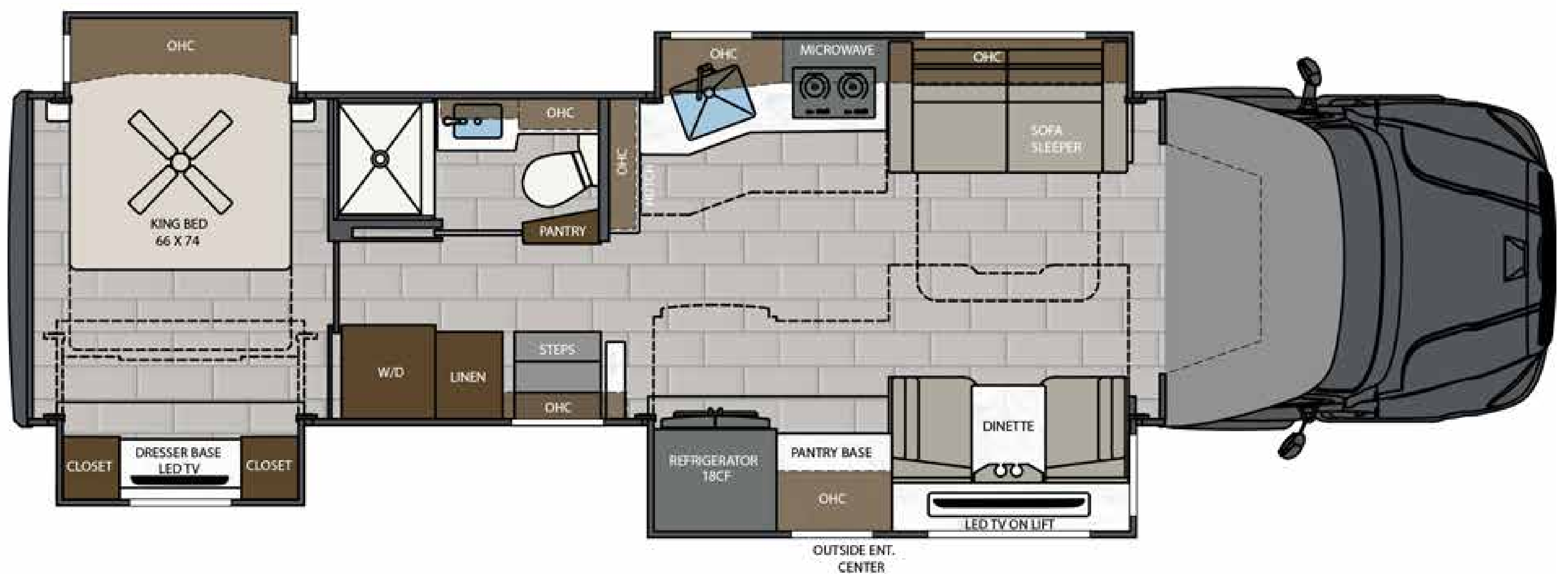

RENEGADE RV EXPLORER 38EMB SPECS

- ▶ ENGINE: DETROIT DD13
- ▶ GCWR: 41,000
- ▶ FRESH/GRAY/BLACK: 150/75/75
- ▶ EXT LENGTH: 38' 6"
- ▶ EXT HEIGHT: 13' 2"
- ▶ EXT WIDTH: 99.25"



→ GRAND DESIGN LINEAGE

Check out the new 2025 Grand Design Lineage, where modern design meets exceptional functionality.

Inside, the open floor plan features high-end materials and a gourmet kitchen equipped with modern appliances and ample storage. The spacious living area offers comfortable seating and a state-of-the-art entertainment system, while the master suite provides a luxurious retreat with a cozy bed and wardrobe.

With innovative technology and thoughtful amenities, this is the perfect compact choice, blending comfort and style for unforgettable journeys.



GRAND DESIGN LINEAGE SERIES M SPECS

- ▶ ENGINE: N/A
- ▶ GCWR: 15,249
- ▶ FRESH/GRAY/BLACK: 35/34/34
- ▶ EXT LENGTH: 25' 8"
- ▶ EXT HEIGHT: 11' 5"
- ▶ EXT WIDTH: 7' 11"

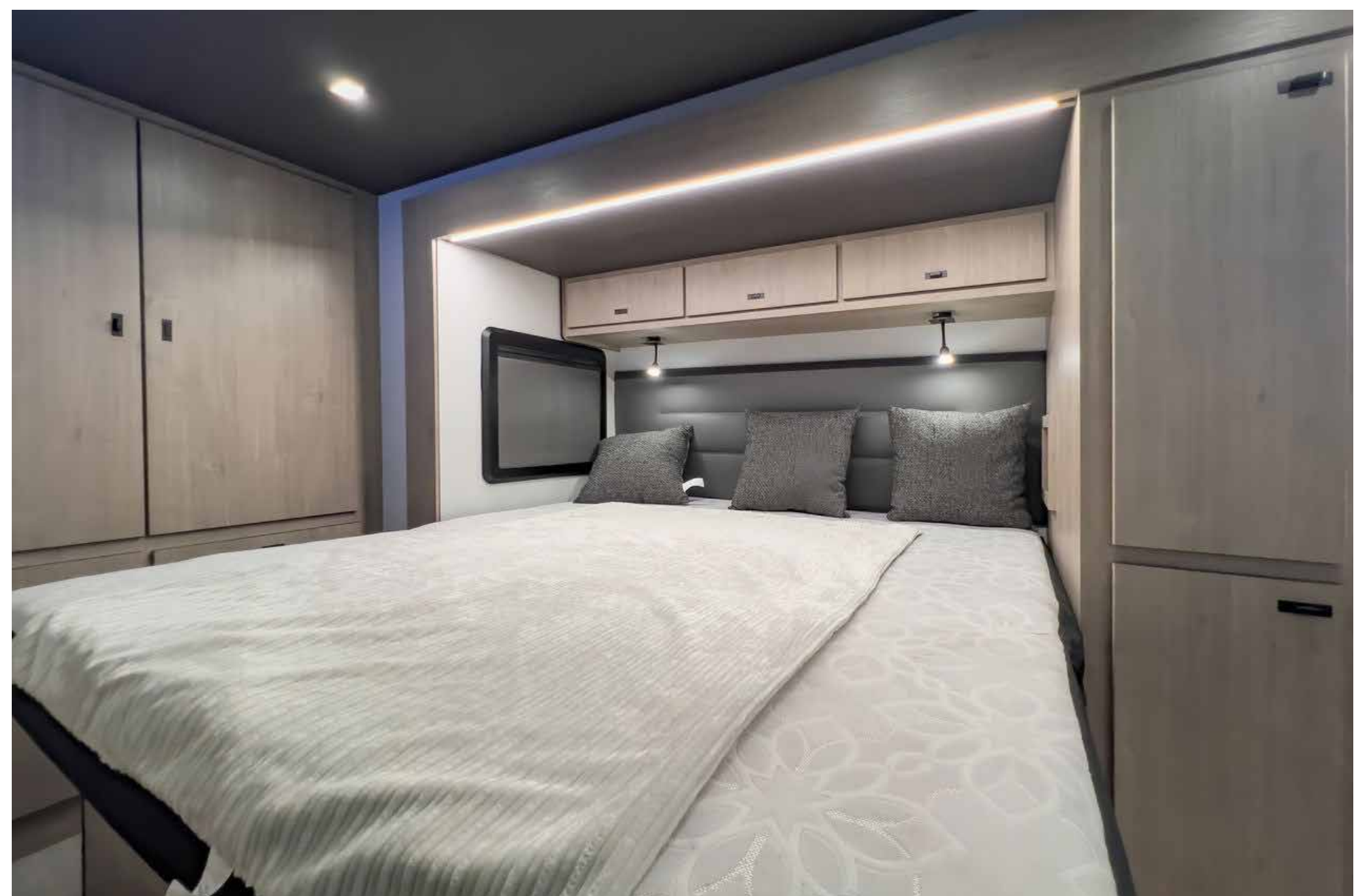

Introducing the Winnebago Revel, a rugged camper van perfect for adventure seekers. Built on a robust Mercedes-Benz Sprinter chassis, it excels in both urban and off-road settings.

The interior features a flexible layout with a fully equipped kitchen and a multifunctional seating area. The innovative bed system easily converts to maximize space and comfort.

With solar panels and a lithium battery system, the Revel ensures modern amenities are available no matter where your travels take you. Whether for a weekend trip or an extended journey, the Winnebago Revel is ready for adventure.



WINNEBAGO REVEL SPECS

- ▶ ENGINE: 2.0L TURBO-DIESEL
- ▶ GCWR: 13,930
- ▶ FRESH/GRAY/BLACK: 35/21/5
- ▶ EXT LENGTH: 19' 6"
- ▶ EXT HEIGHT: 9' 11"
- ▶ EXT WIDTH: 7' 5"



→ VENTURE RV SPORTTREK 5 TOURING EDITION

Introducing the new Venture SportTrek 5 Touring Edition, designed for adventure seekers who value comfort. This travel trailer features a sleek exterior and durable construction.

Inside, the spacious layout includes high-end finishes and a well-equipped kitchen for effortless meal prep. The living area offers comfortable seating, while the private bedroom provides a cozy retreat.

With advanced technology and thoughtful amenities, the Venture SportTrek 5 Touring Edition is perfect for families and outdoor enthusiasts, ensuring every journey is memorable.

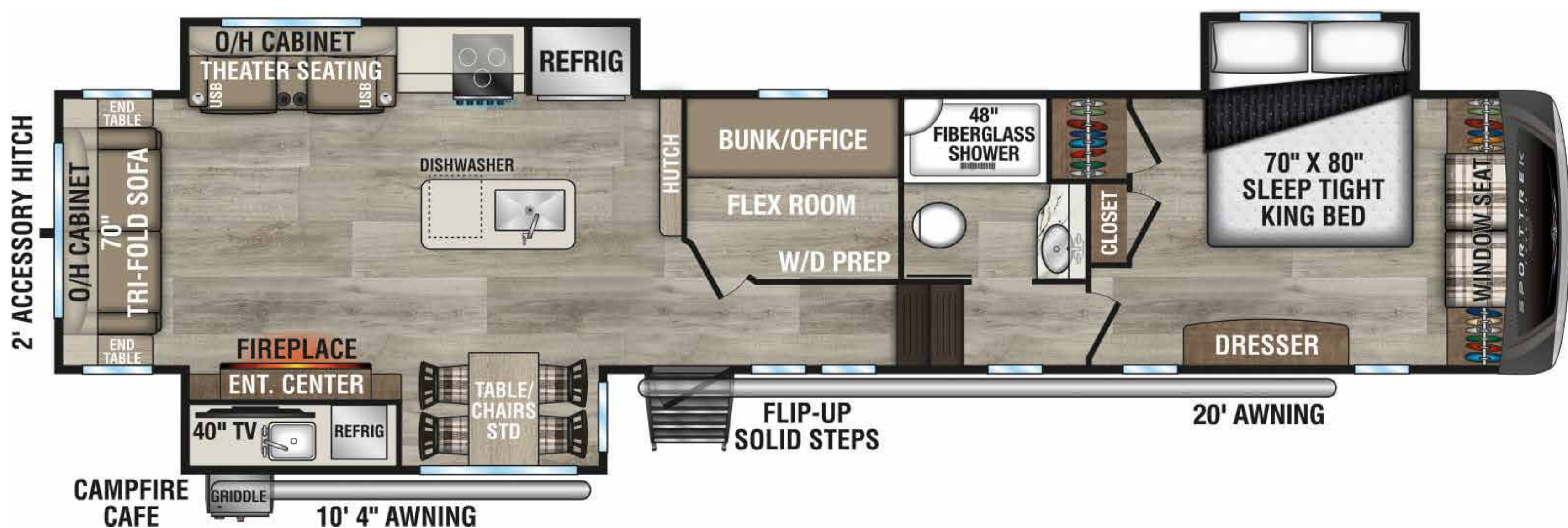

VENTURE RV SPORTTREK 5 TOURING EDITION SPECS

- ▶ HITCH WEIGHT: 2,480
- ▶ GVWR: 14,995
- ▶ FRESH/GRAY/BLACK: 76/100/50
- ▶ EXT LENGTH: 41' 7"
- ▶ EXT HEIGHT: TBD
- ▶ EXT WIDTH: TBD



→ KEYSTONE COUGAR 24RDS

Introducing the new Keystone Cougar 24RDS, a remarkable blend of modern design and exceptional functionality, perfect for your camping adventures. This travel trailer boasts a sleek exterior with eye-catching details, while the spacious interior is thoughtfully designed to maximize comfort and convenience. With high-quality finishes, state-of-the-art appliances, and a well-appointed living space, the Cougar redefines what it means to travel in style. Whether you're setting off for a weekend getaway or long-term stays, the Keystone Cougar 24RDS makes every journey enjoyable and memorable.

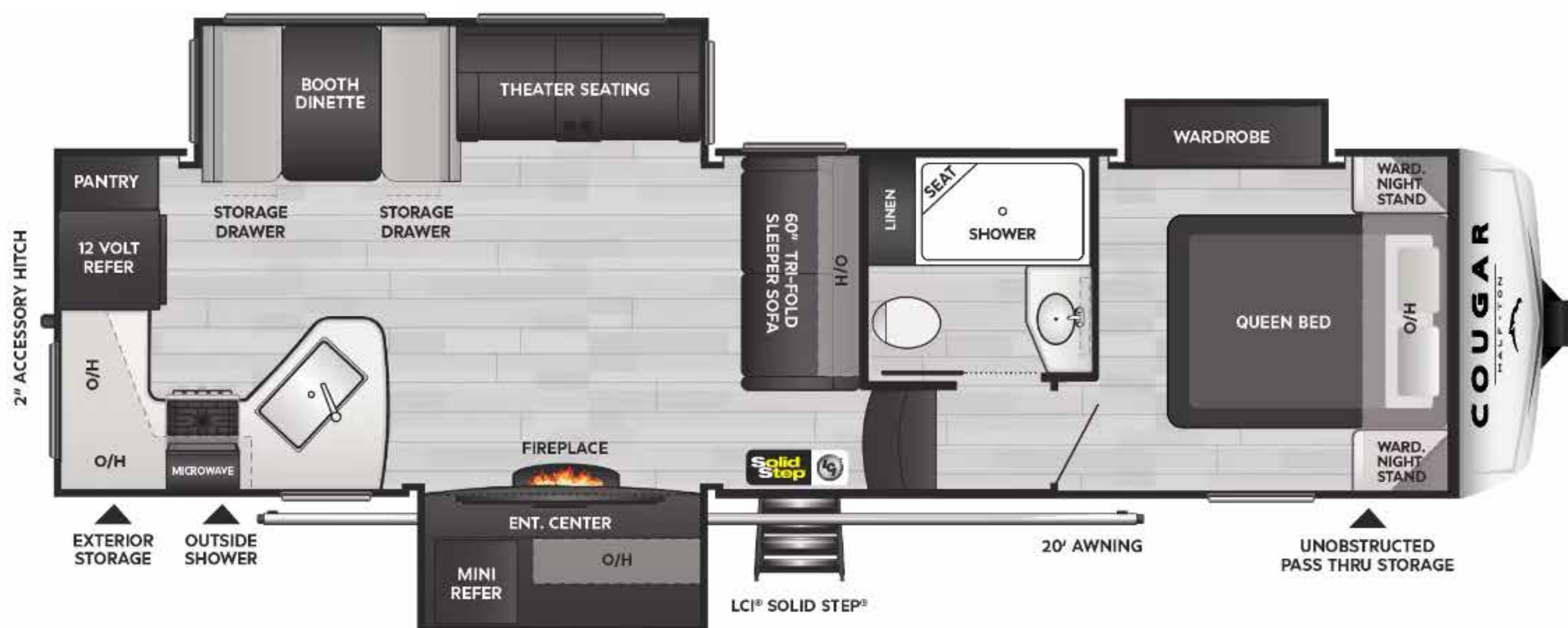

KEYSTONE COUGAR 24RDS SPECS

- ▶ HITCH WEIGHT: 1,430
- ▶ WEIGHT: 8,958
- ▶ FRESH/GRAY/BLACK: 54/60/30
- ▶ EXT LENGTH: 28' 10"
- ▶ EXT HEIGHT: 12' 11"
- ▶ SLEEPS: 6



→ FOREST RIVER SALEM 34 VERANDA

The new 34 Veranda floorplan is a huge change to the rv industry with the all new rear patio deck built into a travel trailer. The exterior deck has a large griddle bbq, outside sink, under counter refrigerator, overhead speakers and misters to keep you cool on those warm summer days!

The living room area has a 240-inch slide out with the l-shape sofa, pantry, fridge, and double bunks all within the slideout. The 34 veranda is the entertainer's coach!

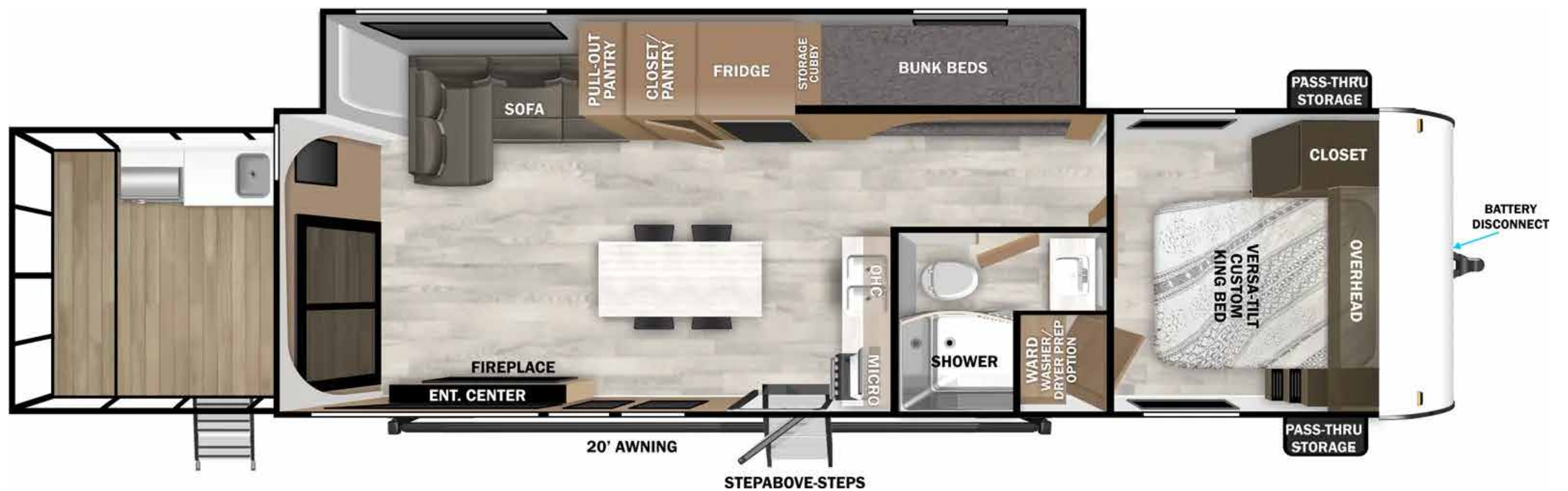

FOREST RIVER SALEM 34 VERANDA SPECS

- ▶ HITCH WEIGHT: 1,185
- ▶ WEIGHT: 9,718
- ▶ FRESH/GRAY/BLACK: 39/40/27
- ▶ EXT LENGTH: 39'
- ▶ EXT HEIGHT: 11' 3"
- ▶ EXT WIDTH: 96"



→ ROCKWOOD GEO PRO G20FBS

Introducing the 2025 Rockwood Geo Pro G20FBS, an exceptional travel trailer designed for adventurers who appreciate both convenience and versatility. Compact yet spacious, the Geo Pro offers a blend of modern technology and comfortable living, making it the perfect choice for couples and small families. With a lightweight construction and user-friendly features, this travel trailer is easy to tow and set up at any campground. Inside, you'll find well-utilized space that includes a cozy sleeping area, a fully equipped kitchenette, and stylish accommodations that invite you to unwind after a day of exploration.

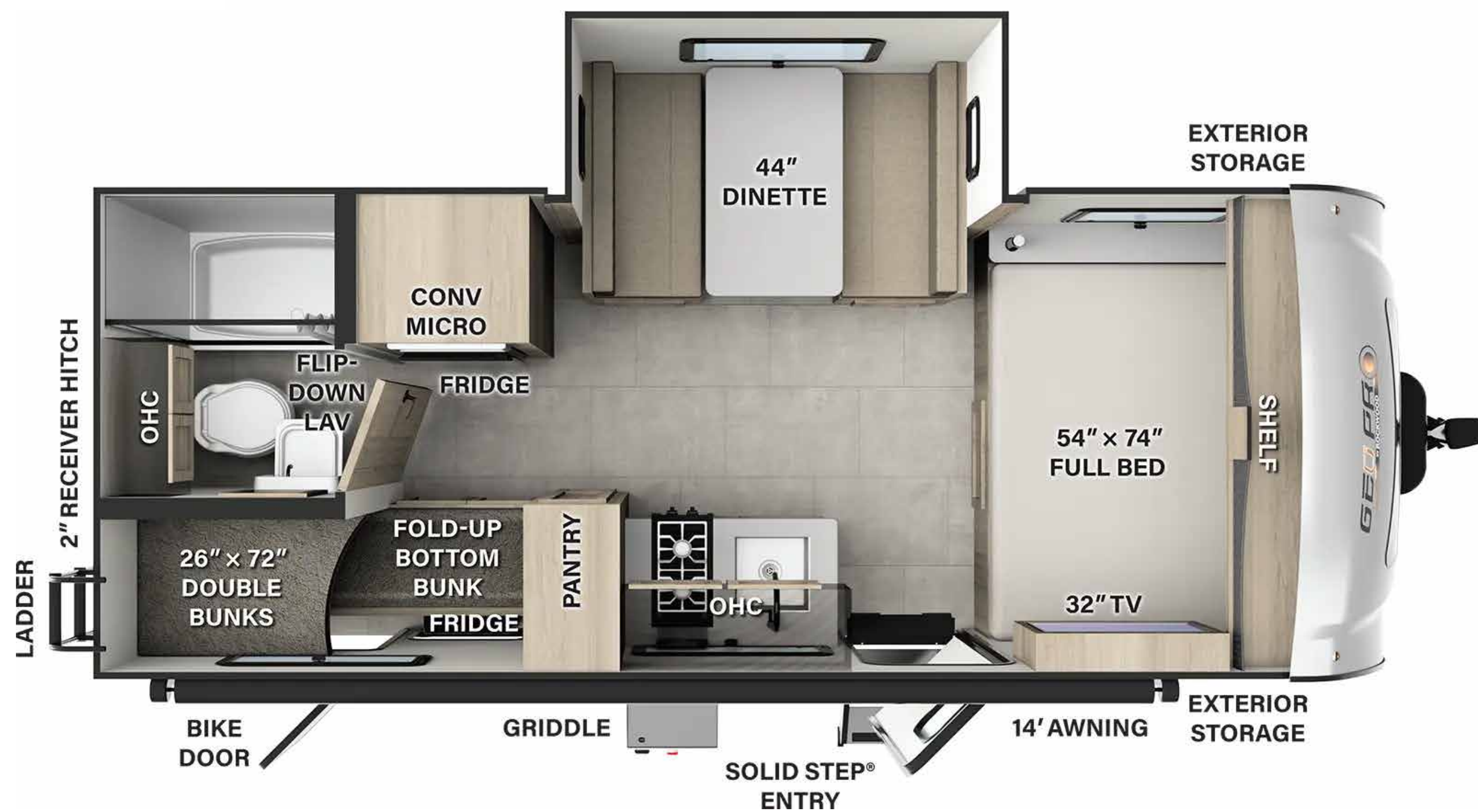

ROCKWOOD GEO PRO G20FBS SPECS

- ▶ HITCH WEIGHT: 398
- ▶ WEIGHT: 3,545
- ▶ FRESH/GRAY/BLACK: 31/27/27
- ▶ EXT LENGTH: 21' 2"
- ▶ EXT HEIGHT: 10'
- ▶ EXT WIDTH: 92"



→ INTECH LUNA ROVER

The new Intech Luna Rover is an innovative and rugged travel trailer designed for outdoor enthusiasts who value comfort and adventure. With its aerodynamic shape and lightweight construction, the Luna Rover enhances fuel efficiency while providing a spacious interior that includes a fully functional kitchen and a cozy sleeping area. Its durable build and high-clearance suspension make it perfect for off-road exploration. Large windows invite natural light and offer stunning views, creating a welcoming atmosphere whether you're at a campsite or in the backcountry. The Intech Luna Rover combines modern amenities with the freedom of the open road, making it the ideal companion for your adventures.

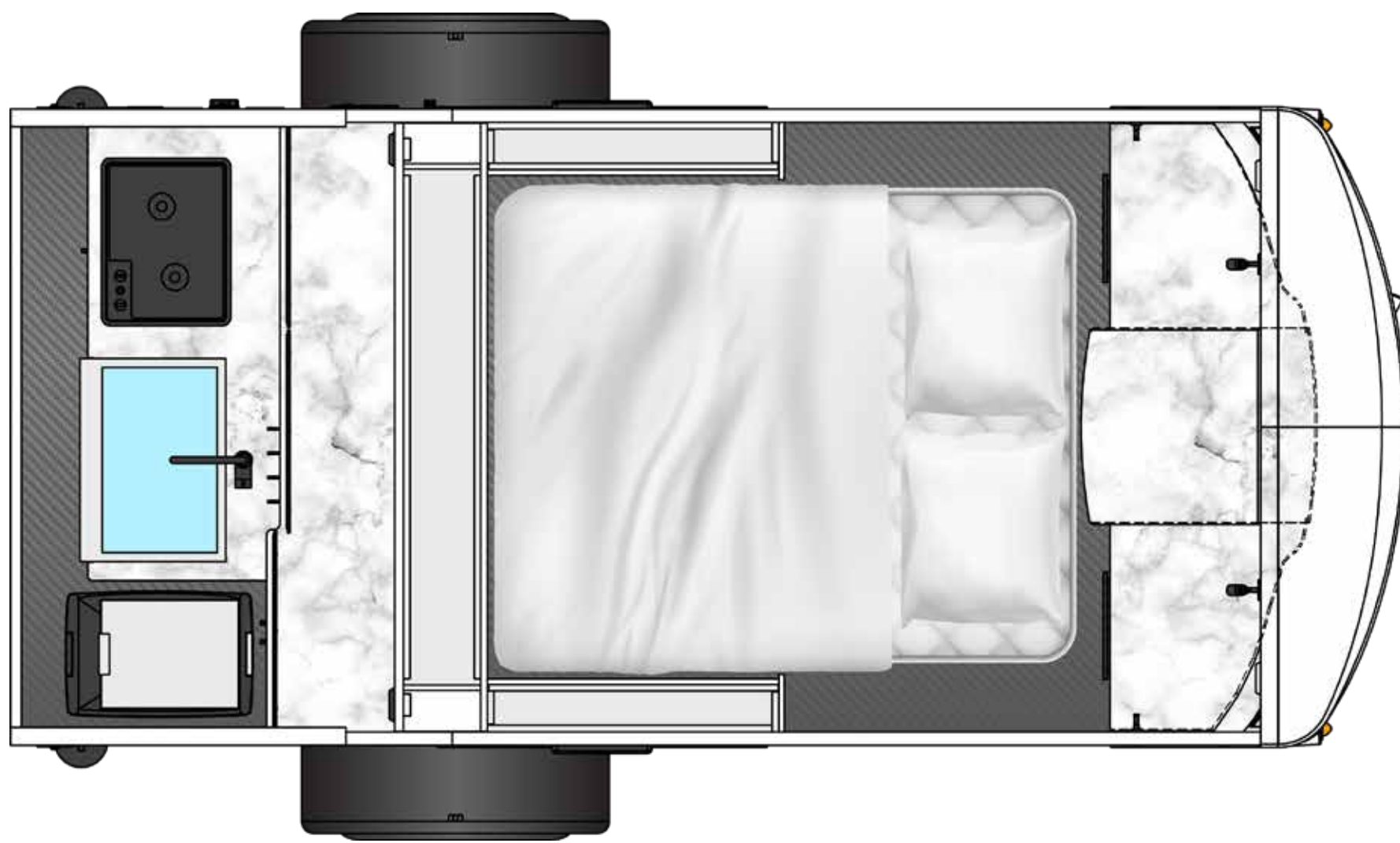

INTECH LUNA ROVER SPECS

- ▶ HITCH WEIGHT: 270
- ▶ GVWR: 2,400
- ▶ FRESH: 8.5 GAL
- ▶ EXT LENGTH: 15' 6"
- ▶ EXT HEIGHT: 7' 2.3"
- ▶ EXT WIDTH: 7' 10"



→ 5K AYAZ TRAVEL TRAILER

Discover the perfect blend of innovation, portability, and style with the 5k Ayaz Travel Trailer. Designed for the modern adventurer, this compact marvel boasts a fiberglass one-piece body that not only enhances its durability but also adds a touch of sophistication to your travel experience.

The 5k Ayaz is crafted with a single-piece fiberglass body, ensuring a seamless and robust structure. This not only enhances the trailer's longevity but also minimizes the risk of leaks, providing you with a worry-free travel experience. Personalize your 5k Ayaz with a wide range of paint color options and combinations to stand out in every RV park.

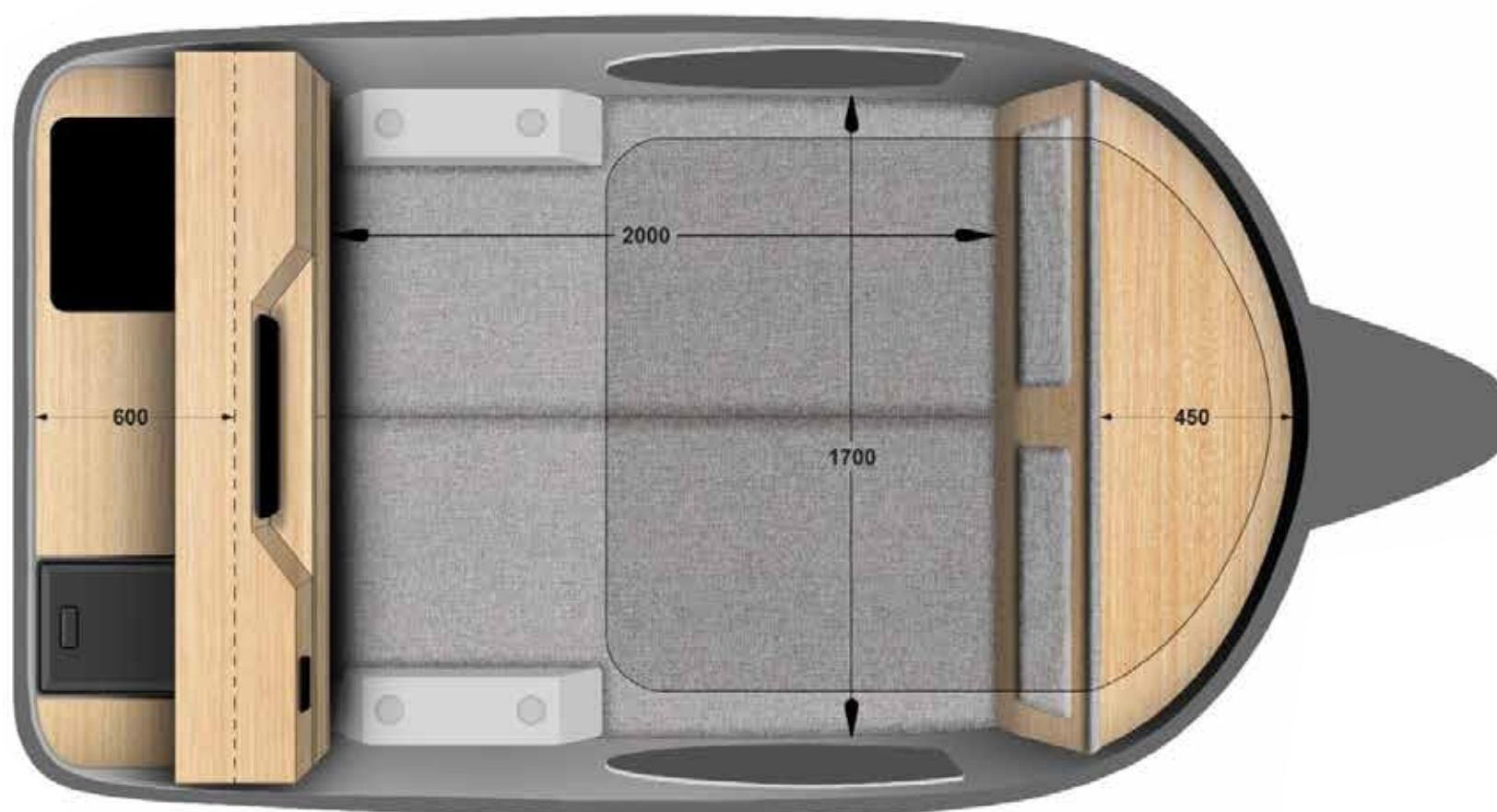

5K AYAZ TRAVEL TRAILER SPECS

- ▶ HITCH WEIGHT: 270
- ▶ GVWR: 2,200
- ▶ SLEEPS: 2/3
- ▶ EXT LENGTH: 14' 1"
- ▶ EXT HEIGHT: 5.6'
- ▶ EXT WIDTH: 6.5'

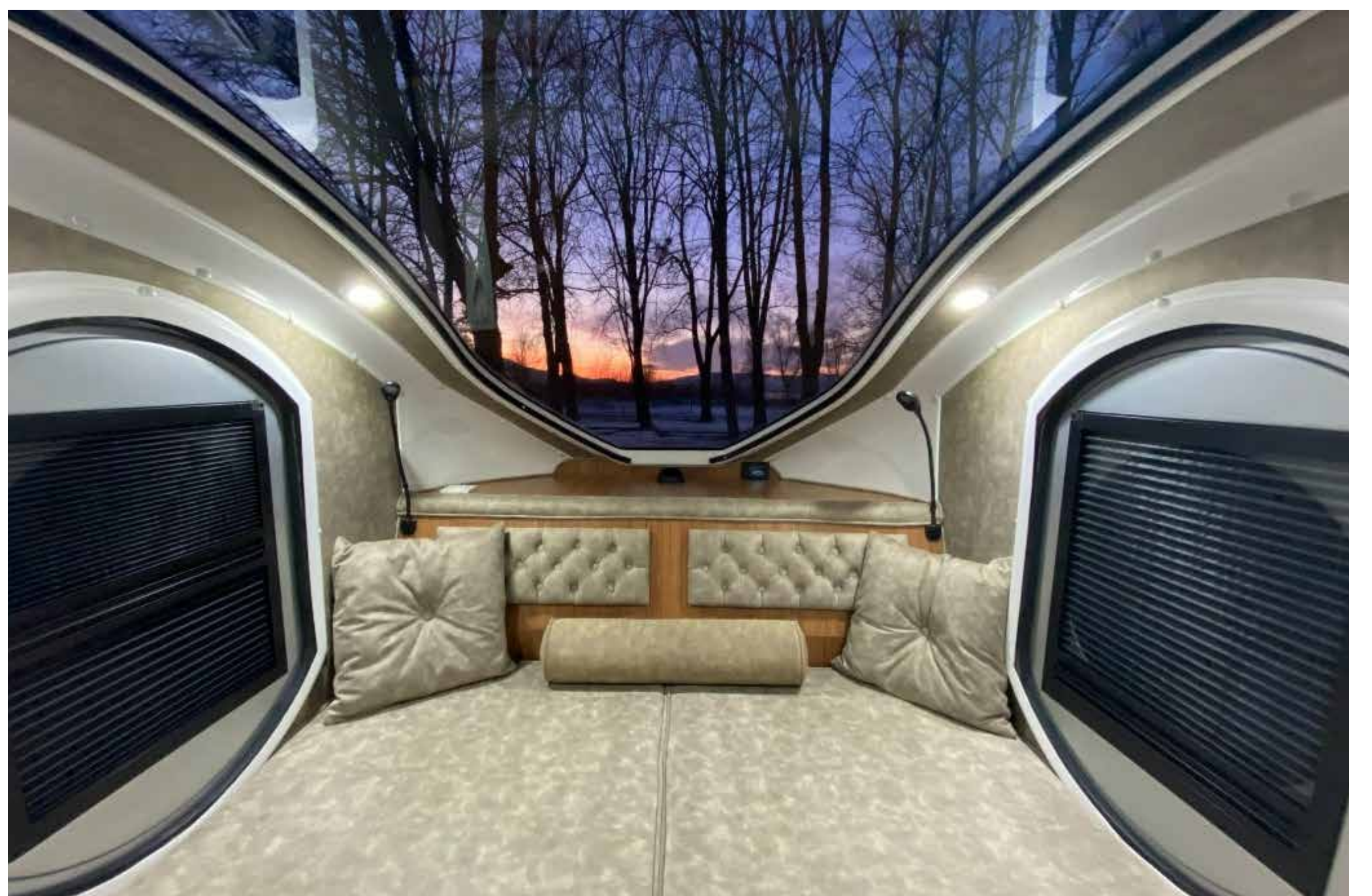

 **CIRRUS 820 TRUCK CAMPER**

The new 2025 Cirrus 820 Truck Camper redefines the camping experience with its perfect blend of luxury and practicality. This innovative camper offers a sleek, aerodynamic exterior that enhances fuel efficiency while traveling. Step inside to find a thoughtfully designed living space equipped with premium materials, including a spacious kitchen with a two-burner cooktop, a comfortable sleeping area, and a full bathroom featuring a shower. Large windows flood the interior with natural light, creating an inviting atmosphere, while the advanced insulation ensures comfort in any weather. With additional features like solar panel capabilities and large awnings, the Cirrus 820 is the perfect premium truck camper.

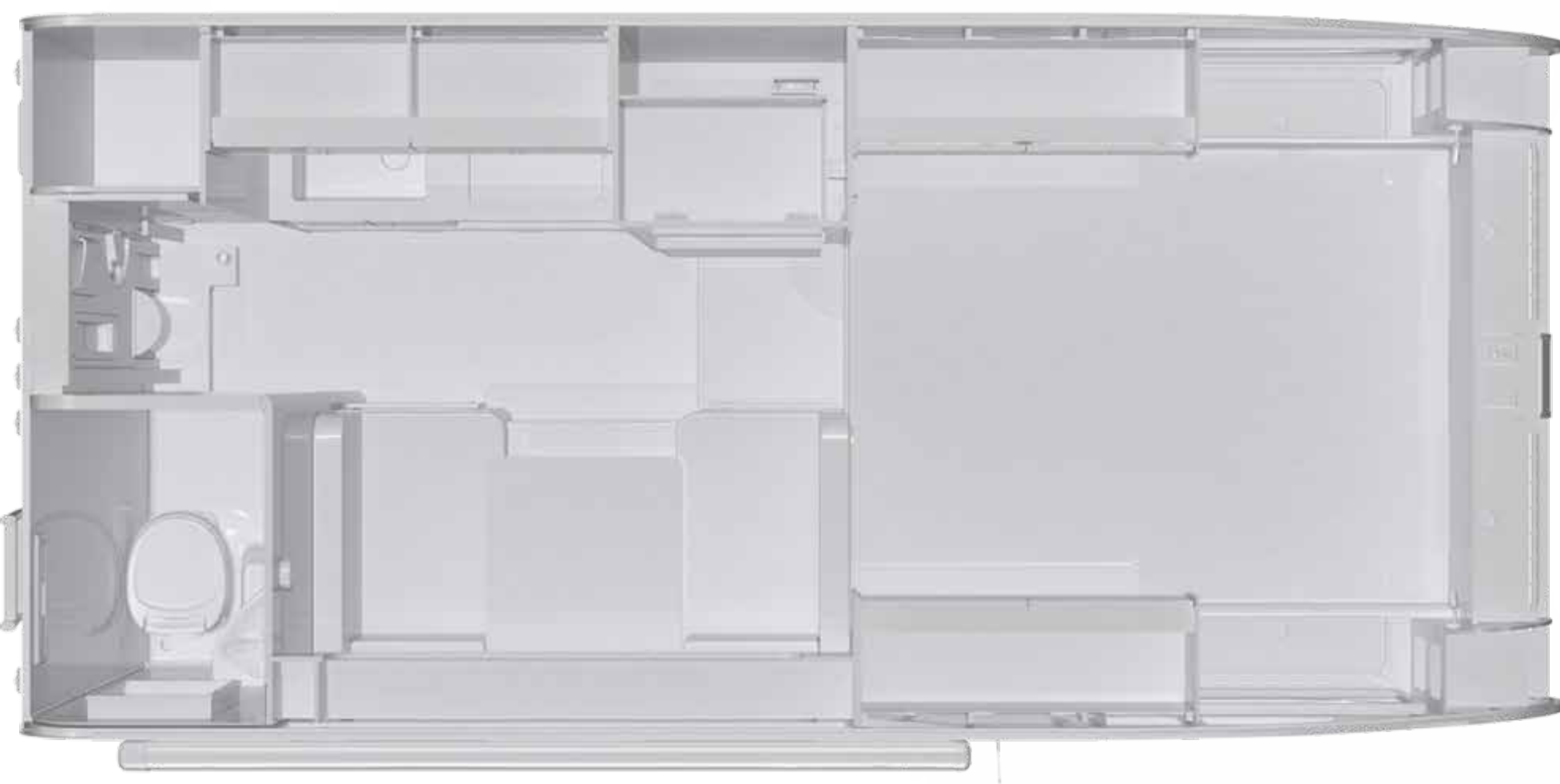

CIRRUS 820 TRUCK CAMPER SPECS

- ▶ GROSS WEIGHT: 2,876
- ▶ FRESH/GRAY/BLACK: 38/33/28
- ▶ SLEEPS: 2/3
- ▶ EXT LENGTH: 17' 8"
- ▶ EXT HEIGHT: 10' 0"
- ▶ EXT WIDTH: 8' 3"



EDGE OF THE MAP

FROM THE HIGHWAY TO THE CAMPGROUND



*INSIDE: Your Next
Getaway Plan*

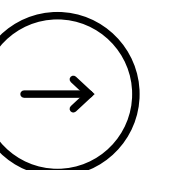

Give Me S'moregon

EXPLORING THE OREGON COAST



YAQUINA BAY

NEWPORT, OR

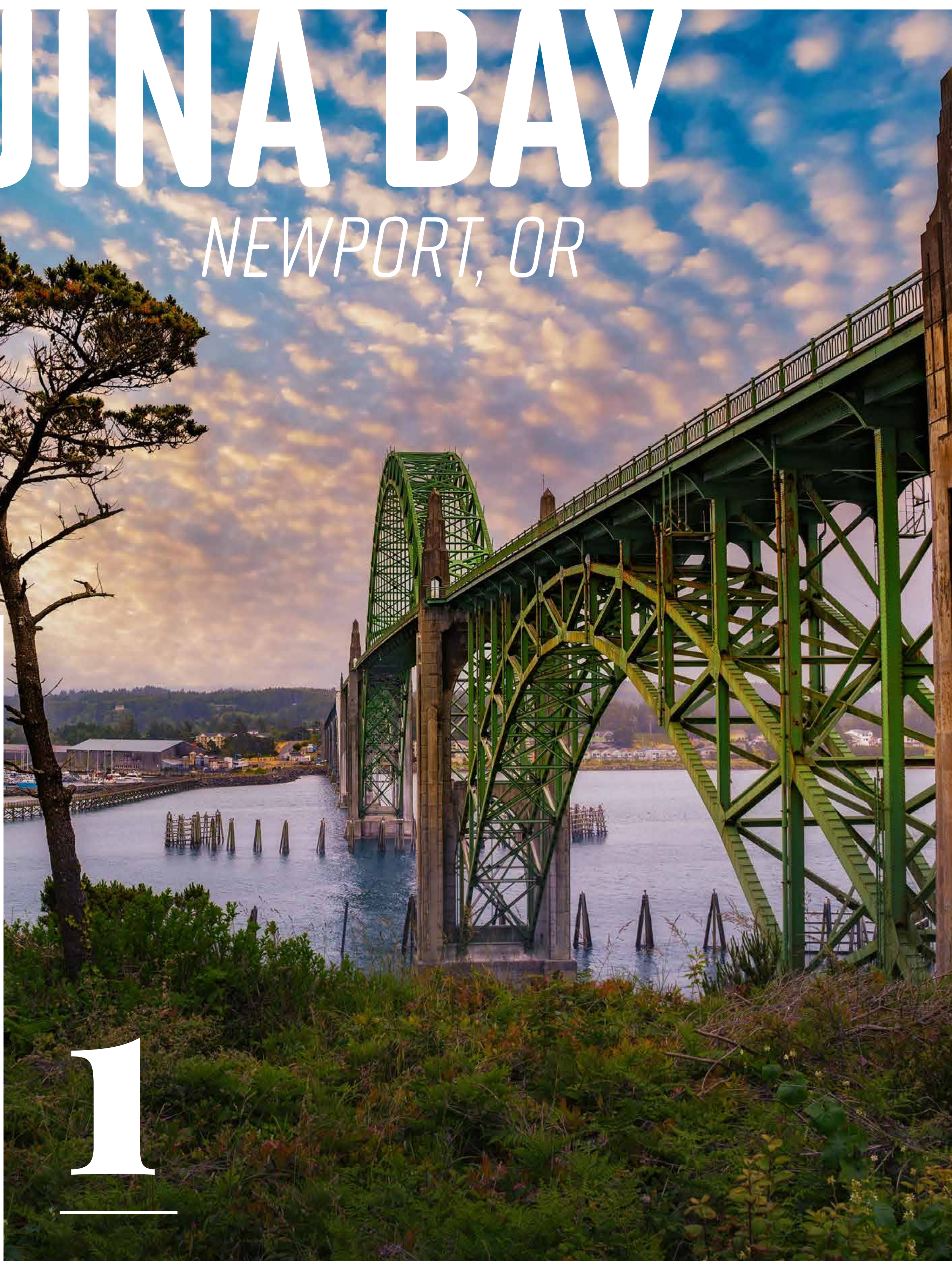
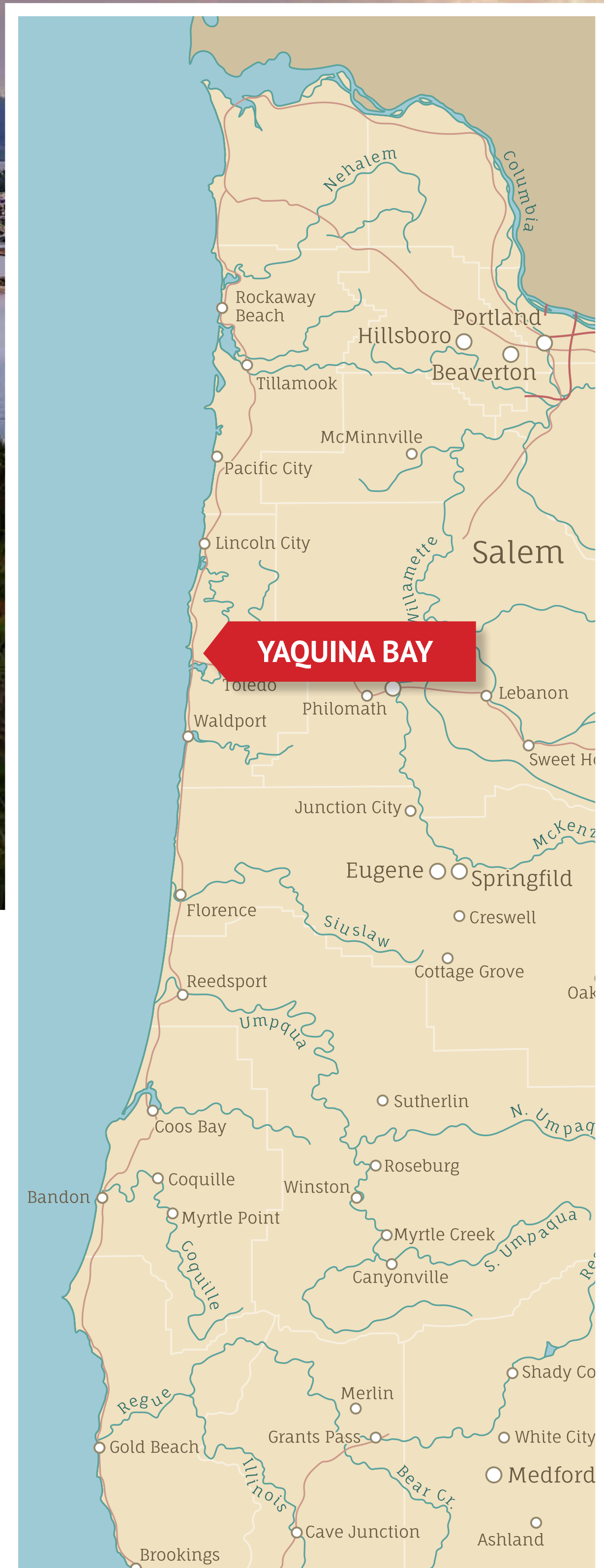

1

Winter on the Oregon Coast offers a serene and enchanting experience. With fewer crowds, you can truly immerse yourself in the rugged beauty of this stunning coastline. The picture above offers a glimpse of a golden sunset over Yaquina Bay, casting a warm glow over the water. The iconic Art Deco architecture of Yaquina Bay Bridge stands proudly in an area that seamlessly blends the wonder of nature with impressive human craftsmanship.

From dramatic storm-watching to peaceful beachcombing, winter unveils a quieter, more introspective side of the Oregon Coast, making it the perfect season for exploration.



From Yaquina Bay Bridge, take US-20 E to Corvallis, then OR-34 E to I-5 N. Continue north on I-5 for about 85 miles to reach Portland. Total drive time: ~2.5 hours.

Portland blends urban charm with natural beauty, offering a wide variety of activities, from exploring Forest Park's trails to visiting Powell's City of Books to enjoying the vibrant food cart scene. The city is also home to highlights such as the Portland Japanese Garden, Lan Su Chinese Garden, and the iconic Pittock Mansion with panoramic views.

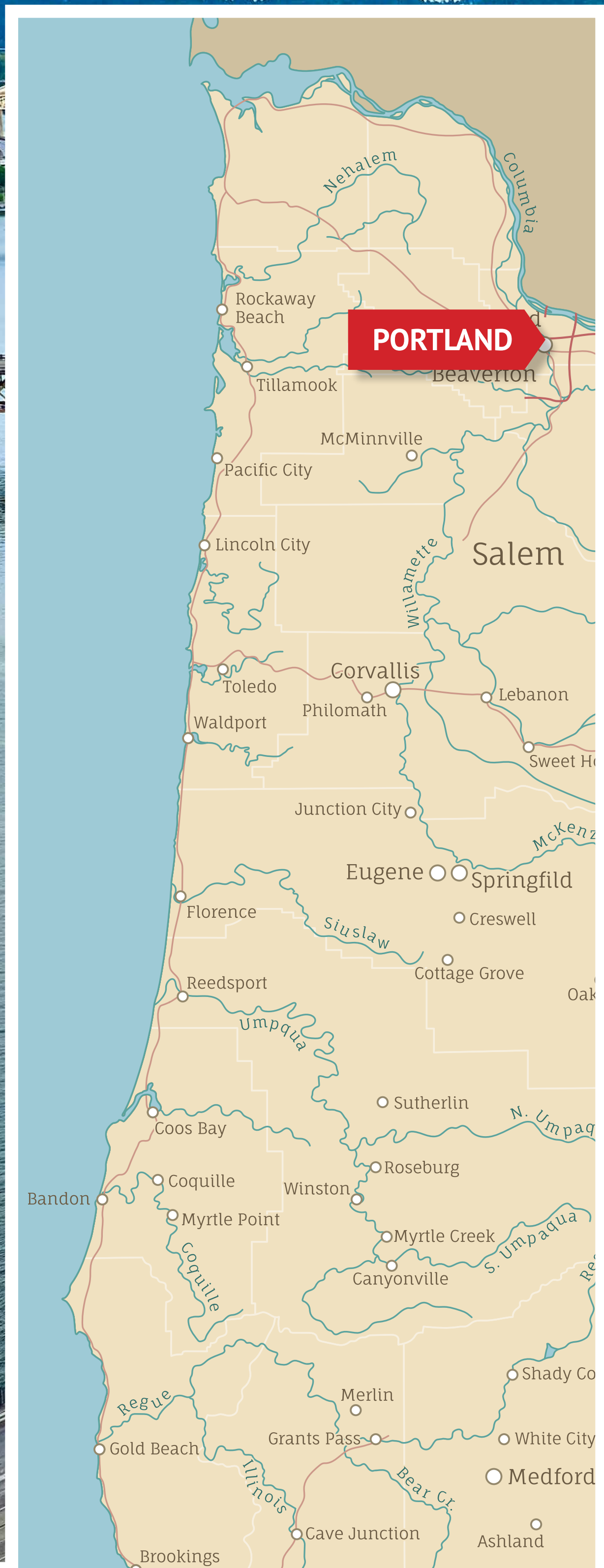

PORTLAND

ECOLA STATE PARK

CLATSOP COUNTY, OR

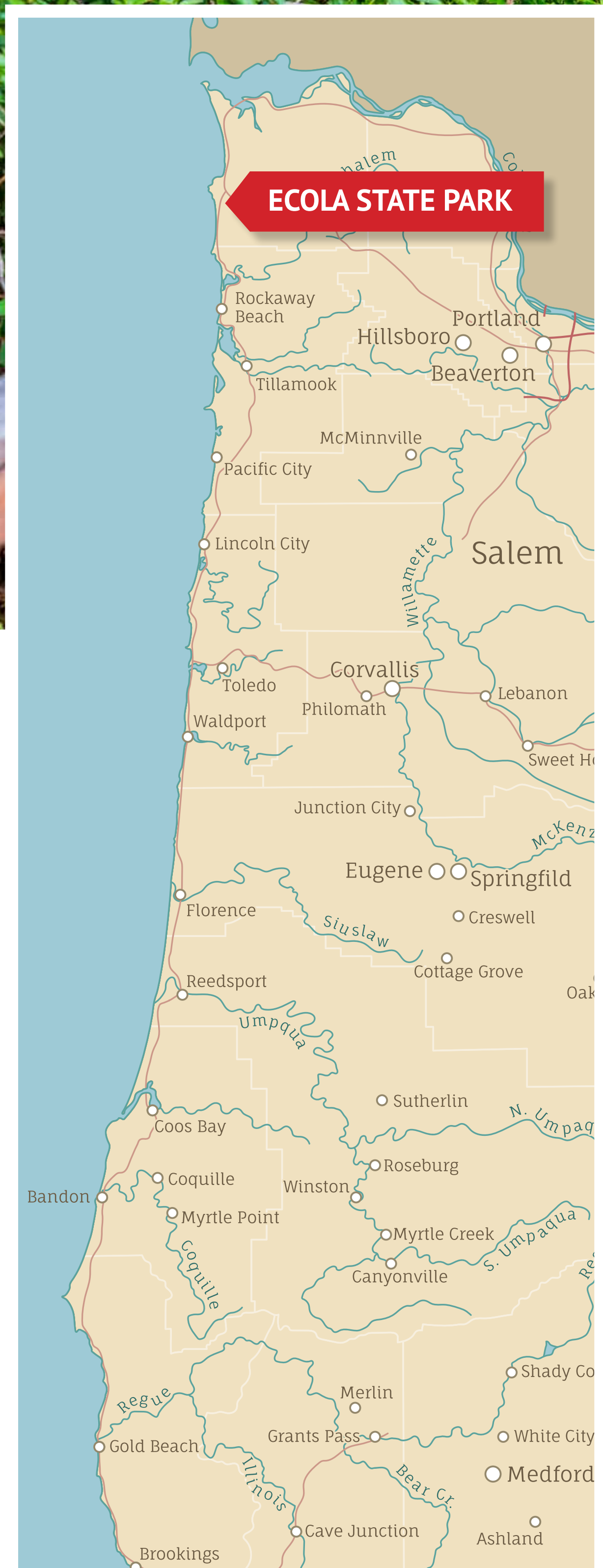

3



From downtown Ecola, take State Road 40 E for about 7 miles to reach the park's main entrance. The drive takes approximately one hour.

Ecola State Park offers breathtaking natural landscapes with lush forested trails and myriad outdoor activities, including hiking along portions of the historic Oregon Coast

Trail, tide pooling, surfing, and wildlife (including whale) spotting. Perched along the rugged Oregon Coast, you'll find some of the most breathtaking views of the Pacific Ocean. Exploring scenic viewpoints like Indian Beach, a favorite for surfers and photographers alike, and sweeping vistas from Ecola Point, which showcase iconic landmarks like Tillamook Rock Lighthouse and the jagged coastal cliffs.

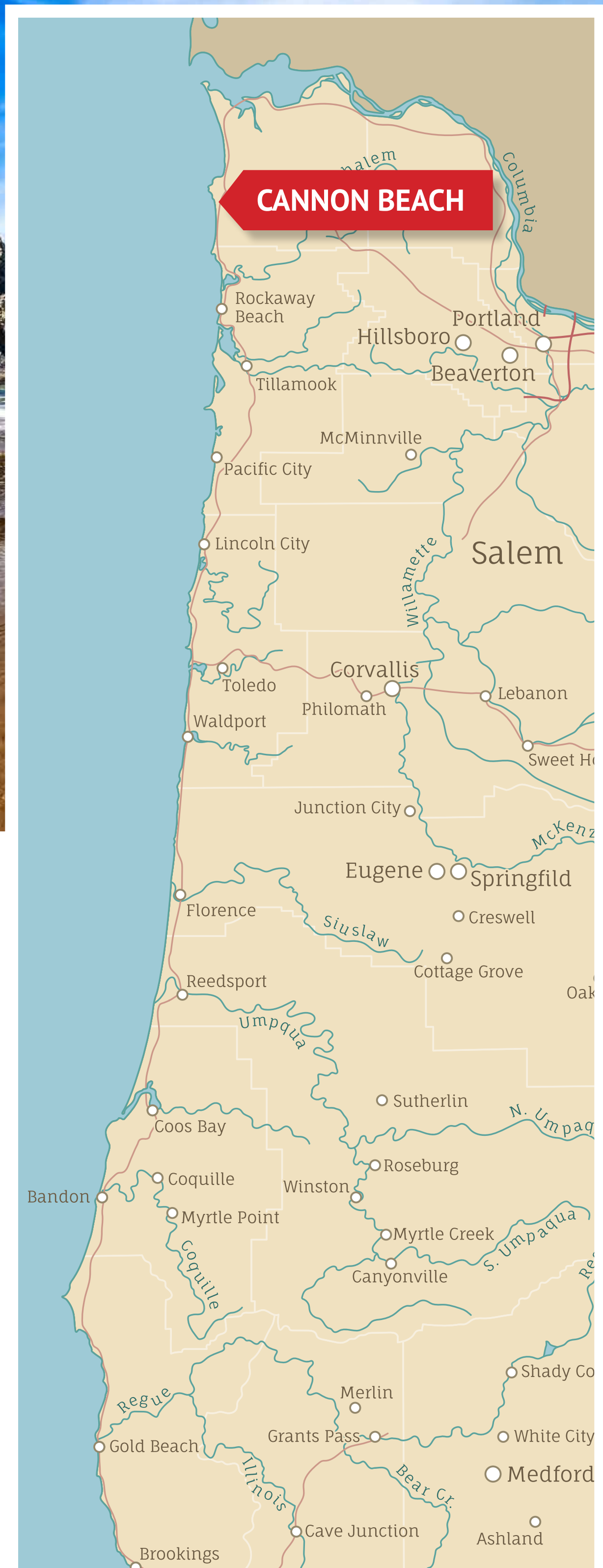

From Portland, take US-26 W for approximately 75 miles to reach Cannon Beach. The drive takes about an hour and a half.

Cannon Beach is one of Oregon's most iconic coastal destinations, famous for its stunning Haystack Rock, tide pools, and expansive sandy beaches. Visitors can enjoy activities such as beachcombing, tide pooling, kite flying, and photography. After soaking up all the natural surroundings, you can then head into town to stroll through charming art galleries and shops.

NAHALEM BAY

STATE PARK, OR

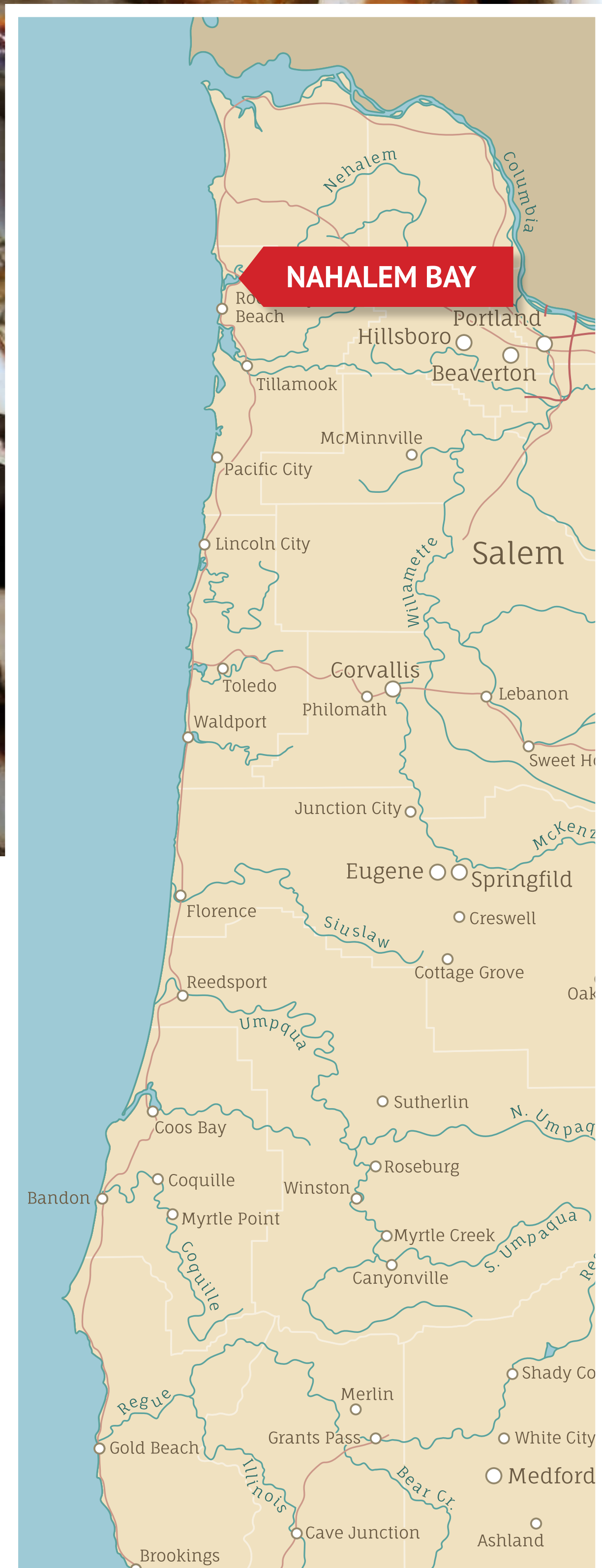

5



From Cannon Beach, head south on

US-101 for about 17 miles to reach Nahalem Bay.

The drive is only about 30 minutes, giving you plenty of time to slow down and enjoy the views or stop and explore along the way.

Nahalem Bay is a haven for fresh-caught Dungeness crab, a local delicacy that draws seafood lovers year-round. Looking for a hands-on experience? Visitors can rent crabbing gear, cast pots from the docks, or head out on a crabbing boat. No desire to catch your own? Many local restaurants serve freshly steamed crab, offering a true taste of the Oregon Coast.

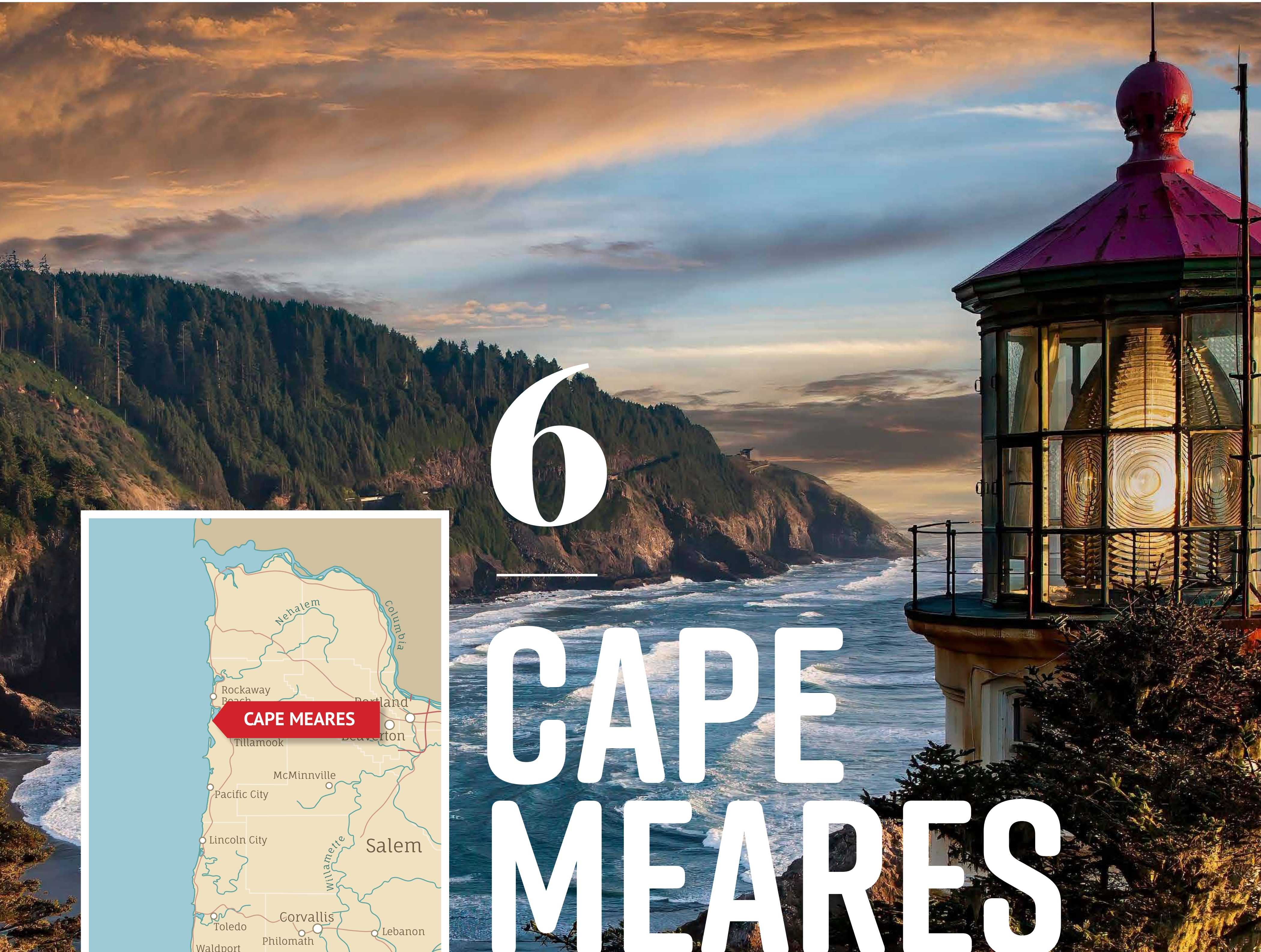

6

CAPE MEARES

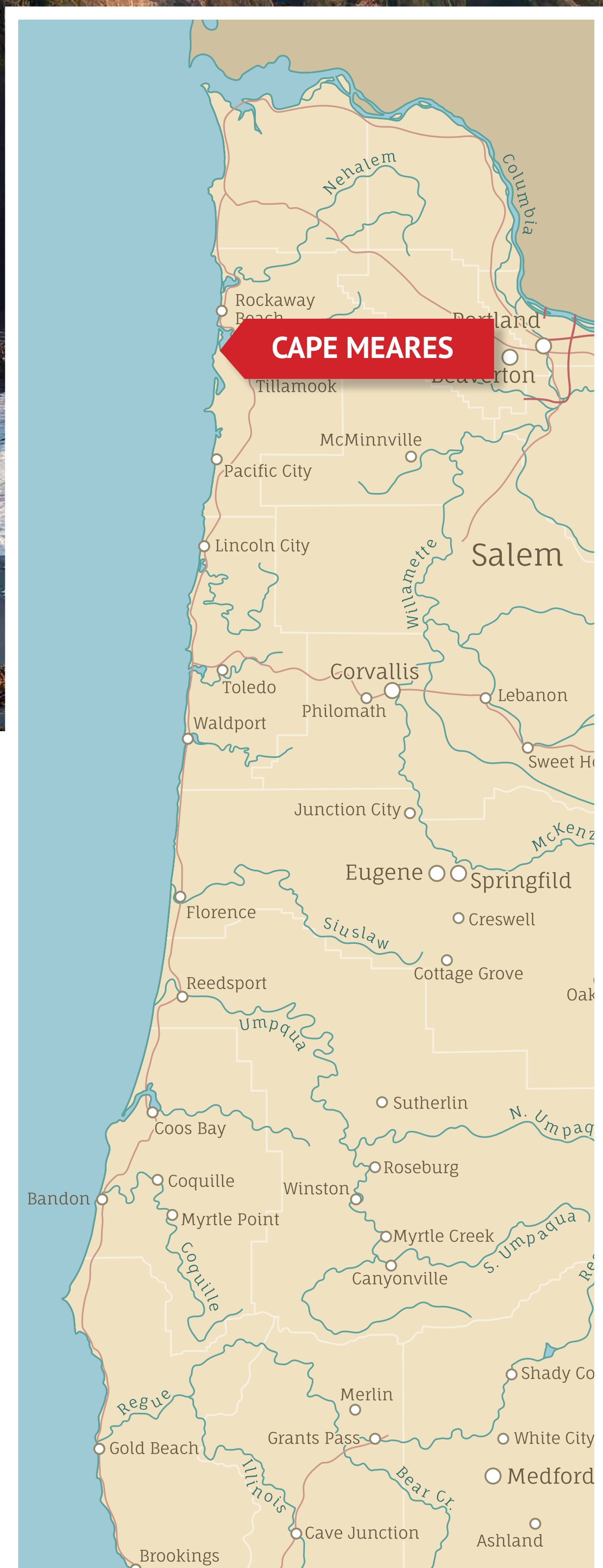

From Nehalem Bay, take US-101 S for about 30 miles to Tillamook, and then follow OR-131 W for 10 miles to Cape Meares. The drive takes just under an hour.

Cape Meares is a stunning coastal destination known for its historic lighthouse, breathtaking ocean views, and abundant wildlife. The Cape Meares

Lighthouse, one of the shortest on the Oregon Coast, offers fascinating history and photo opportunities. The area is part of the Three Capes Scenic Loop and features several walking trails, including the path to the famous Octopus Tree, a centuries-old Sitka spruce. Much to their delight, birdwatchers and nature enthusiasts will have a chance to spot puffins, pelicans, and even migrating whales in the winter.

THORSWELL

YACHATS, OR

7

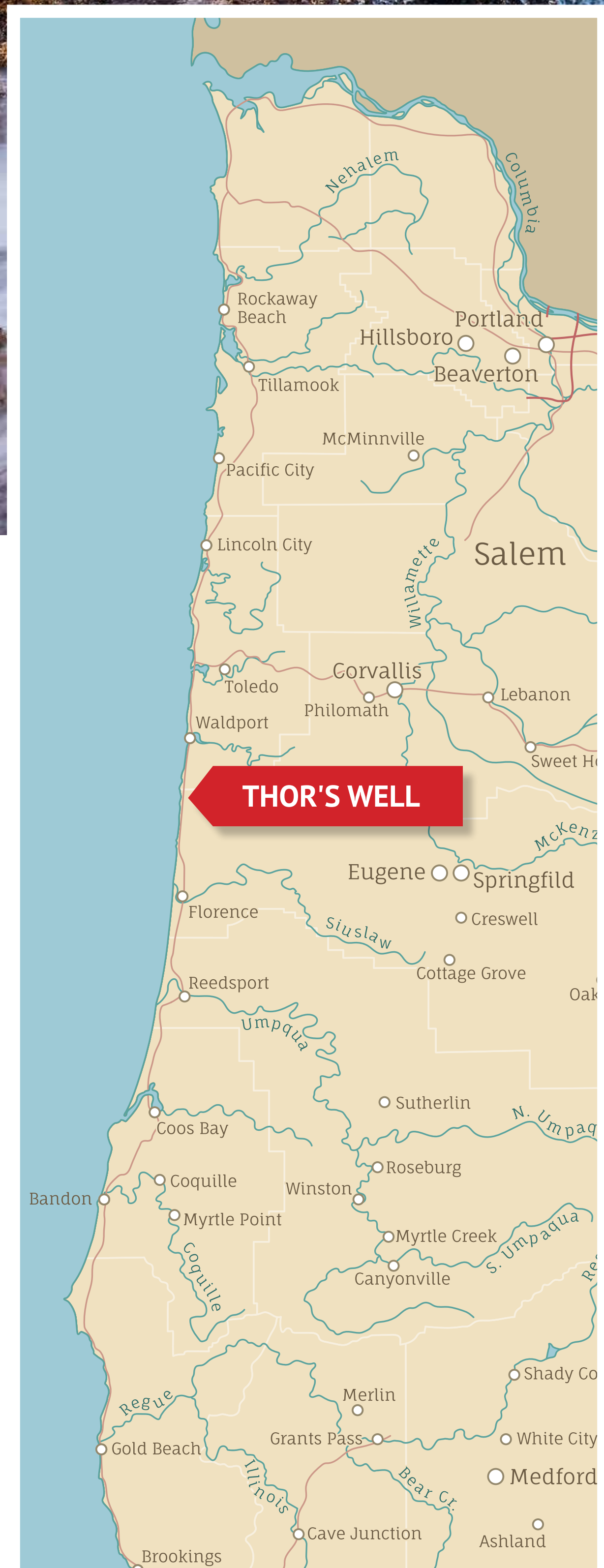

From Cape Meares, head south on US-101 for about 80 miles to Yachats. Continue three miles south to Cape Perpetua Scenic Area and follow signs to Thor's Well. The drive takes about two and a half hours.

Thor's Well, a natural sinkhole along the Cape Perpetua coastline, is one of Oregon's most mesmerizing sights. Carved by centuries of powerful waves eroding the volcanic basalt shoreline, this dramatic feature

appears to drain the ocean during high tide. Visitors can marvel at the well's surging water and cascading waves, making it a favorite spot for photography.

Activities include tide pooling and exploring nearby trails such as the Captain Cook Trail, which offers additional views of this unique geological formation. That said, Thor's Well is best viewed during high tide, but be cautious of strong waves and slippery rocks. Keep a safe distance to avoid being caught by unexpected surges.



From Thor's Well, continue south on US-101 for approximately 140 miles to reach Gold Beach. The scenic drive takes about 3 hours.

Gold Beach is a charming coastal town where the Rogue River meets the Pacific Ocean, offering a blend of adventure and relaxation. Visitors can enjoy views of the Rogue River, fishing, hiking through lush forests, or simply strolling along the pristine winter beaches. The area is also known for its stunning sunsets and

proximity to Samuel H. Boardman State Scenic Corridor, featuring dramatic cliffs, sea stacks, and hidden coves.

Don't miss the chance to visit the historic Isaac Lee Patterson Bridge, a stunning Art Deco structure that spans the Rogue River and adds to Gold Beach's unique charm.

GOLD BEACH

8

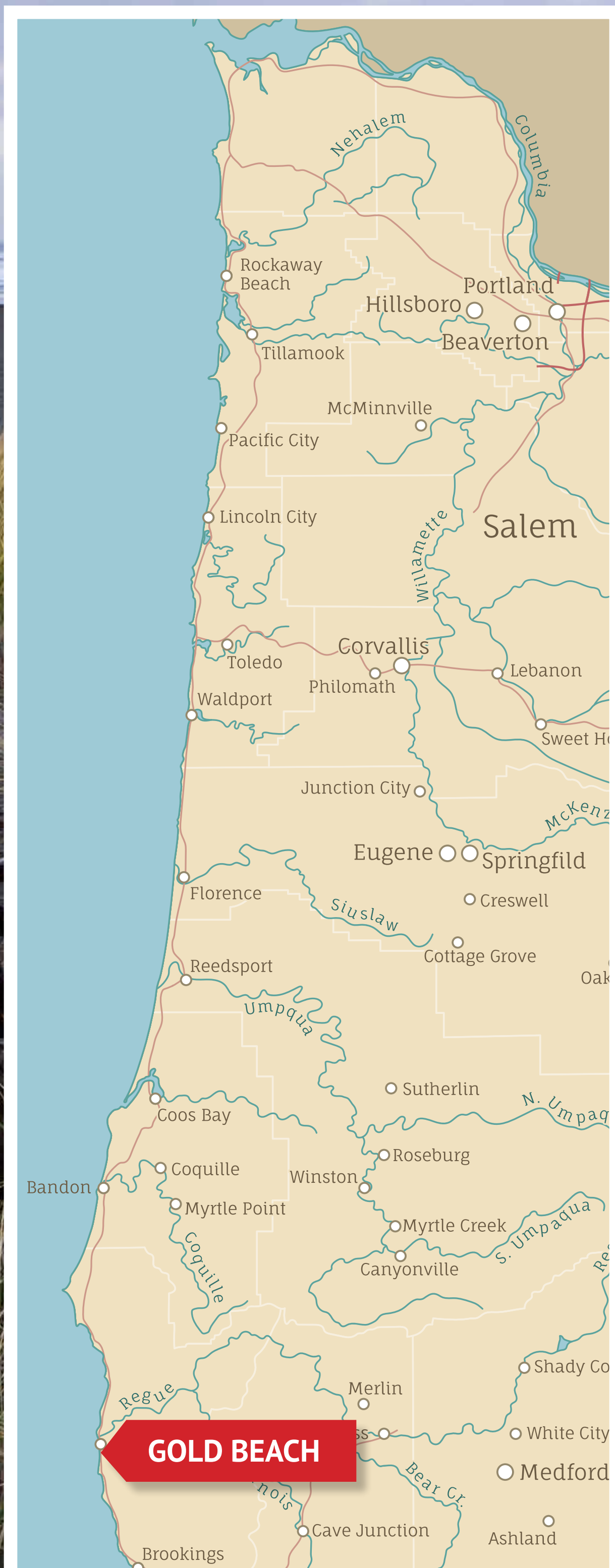

COQUILLE POINT

BANDON, OR



From Gold Beach, head north on US-101 for about

55 miles to Bandon. Follow signs to Coquille Point. The drive takes roughly one hour.

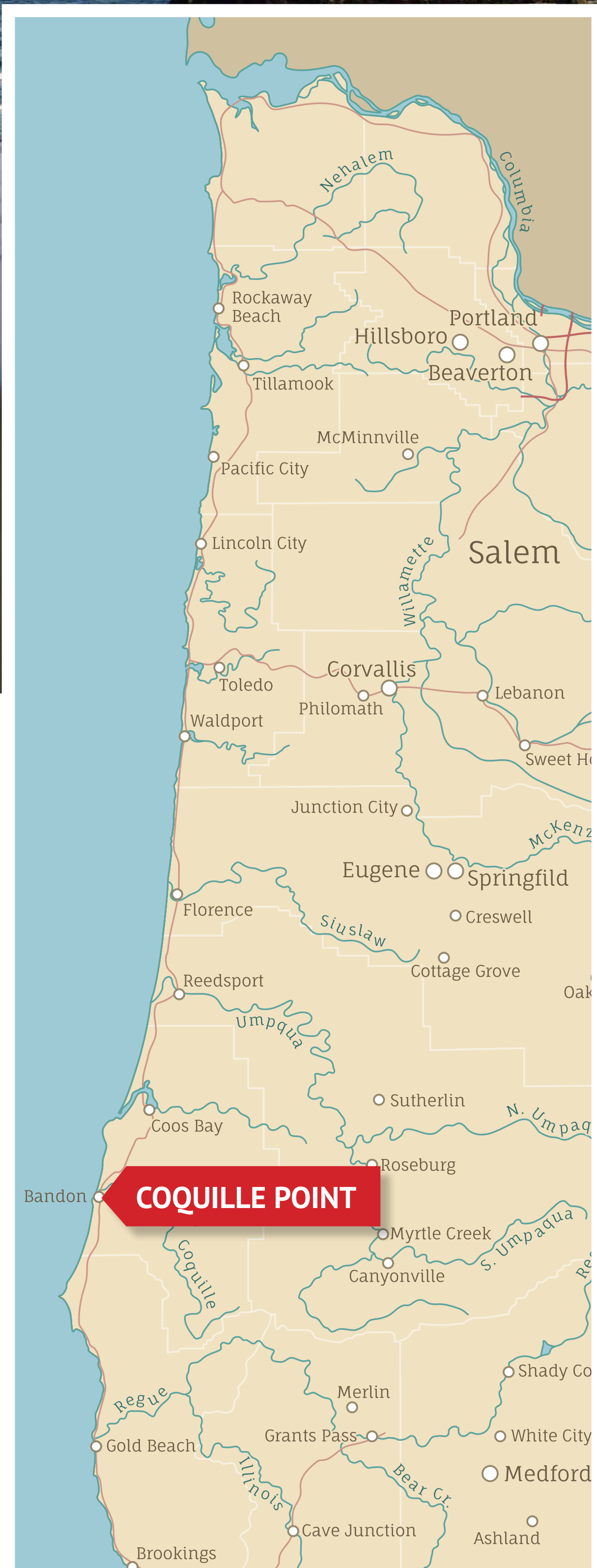

9

Nestled in Bandon, Coquille Point Beach is a serene and picturesque destination, perfect for wrapping up your Oregon Coast adventure. Known for its dramatic sea stacks and tide pools teeming with marine life, this beach offers an ideal setting for quiet reflection and nature exploration. The scenic overlook at Coquille Point provides breathtaking views of the coastline and is a favorite spot for

birdwatching, photography, and catching the last light of the day.

As your journey along the Oregon Coast comes to an end, Coquille Point Beach invites you to pause and savor the tranquility of the Pacific in the cooler months. Whether you're marveling at sea stacks or enjoying a peaceful walk along the shore, it's the perfect finale to a trip filled with unforgettable landscapes and coastal wonders. ❤️

Your Next Getaway Plan



Florida's Scenic Highway 30A

When the winter chill sets in, many of us seek the sun by heading south. If you're ready to thaw out, there are few places better than Florida's scenic Highway 30A.

Found along the sparkling Emerald Coast, Highway 30A provides access to charming beach towns, world-class dining, and pristine white sand beaches. For instance, Rosemary Beach, pictured here, blends European-inspired architecture with Southern hospitality where you can wander through cobblestone streets, browse local boutiques, and enjoy the warm Gulf breezes.



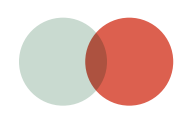

The Walton County coastline boasts over 26 miles of unspoiled beaches bordered by glittering blue waters and rare coastal dune lakes. These natural wonders are unique to this area and offer serene spots for kayaking, paddleboarding, or just soaking up the view.

Protected state parks and nature preserves like Grayton Beach State Park ensure the region's beauty remains untouched to continue providing a tranquil escape. And in winter, with mild temperatures in the low to mid 60s, it's an ideal time to explore, especially if you want to avoid the crowds.

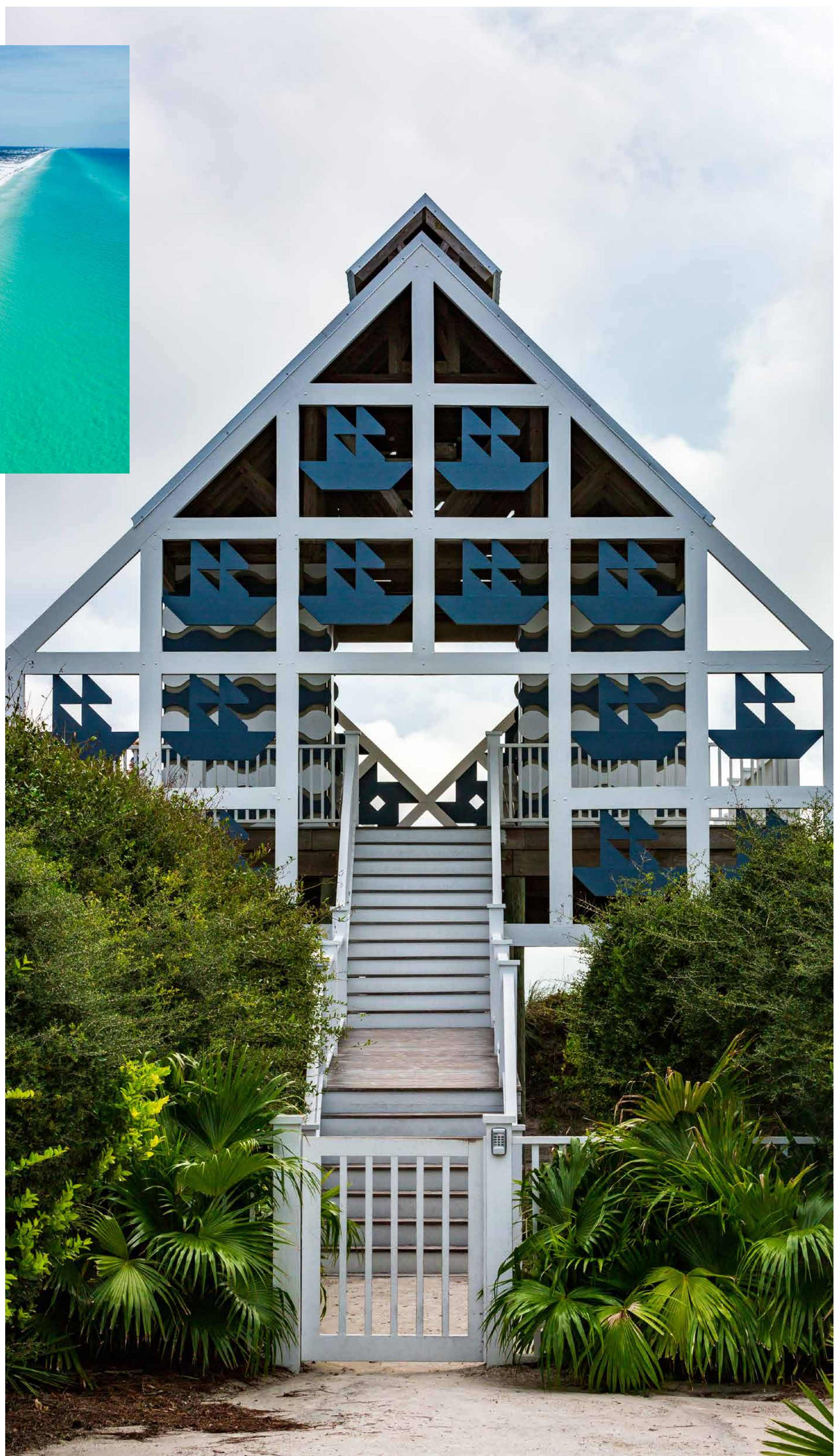

One of Florida's best-kept secrets is the beachside towns along Highway 30A. Each town offers its own unique vibe. Laid-back artsy charm can be found on Grayton Beach. Chic sophistication at Alys Beach. These towns all share a common thread, though: a welcoming community with a dedication to preserving the natural beauty of the area.

Many visitors are surprised and delighted to discover how peaceful 30A can be during this time of year, making it an exceptionally tranquil retreat for those seeking sun and sand and an off-the-beaten-path paradise.

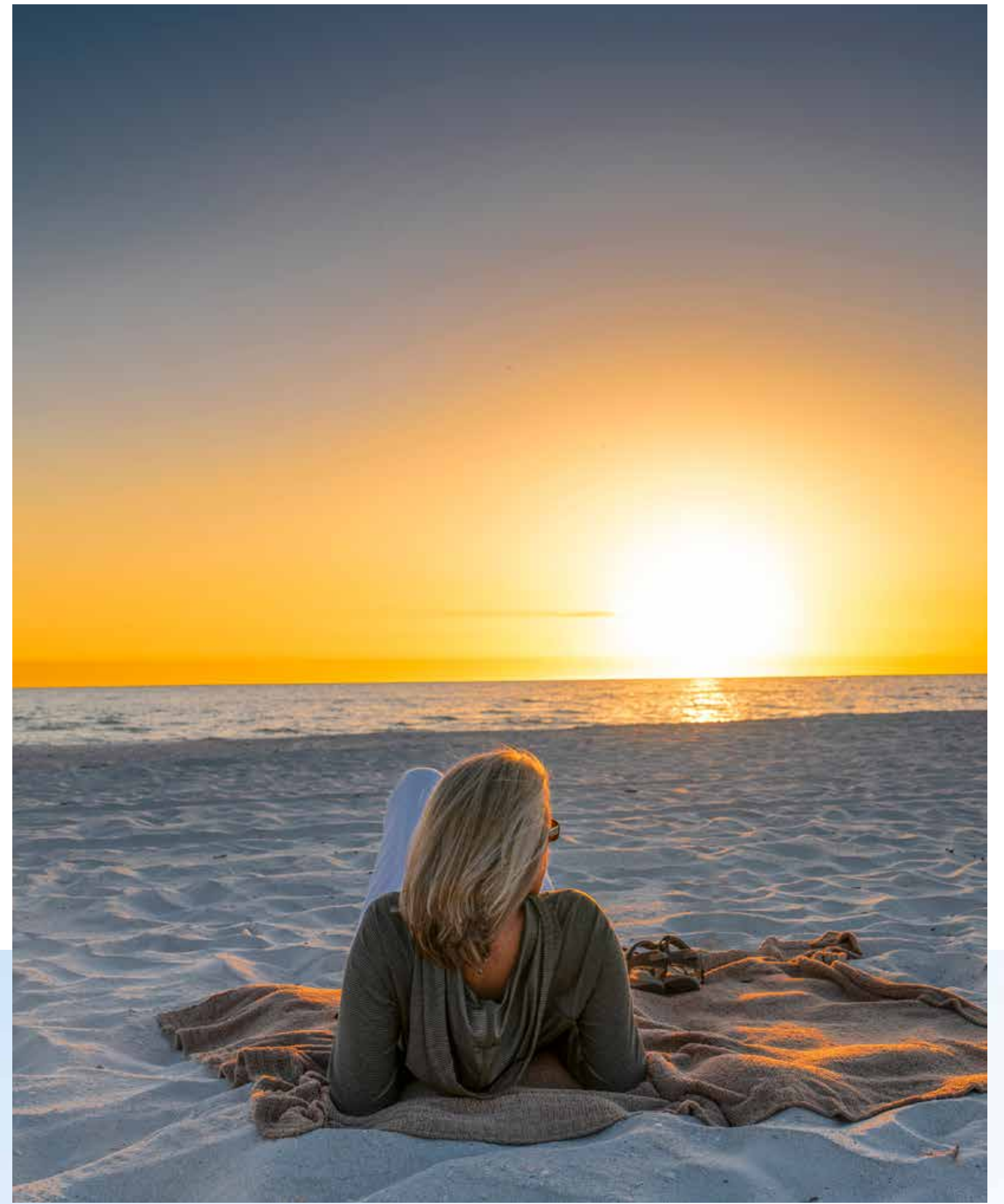

RVX



INSIDE:
Useful,
techy, and
downright
fun gift ideas
for any RVer

CAMPING, ADVENTURE, AND THE RV EXPERIENCE



UNLEASH YOUR CULINARY ADVENTURES WITH THE TG GRILL

The TG Series Portable Grill is the ultimate companion for RVing adventures. Crafted in the USA with precision, this compact stainless steel grill transforms any campsite into a gourmet kitchen.

THE COMPACT AND PORTABLE TRIPLE THREAT

Grill



Griddle



Oven Fire Pizza



Its versatile design not only saves space but also caters to all your cooking needs, making it the perfect addition to your RV lifestyle.



START YOUR TG JOURNEY TODAY.



Holiday

GIFT GUIDE

Whether you live full-time in your RV, spend as much time at dream destinations as possible, or just love an avid RVer, the holiday season is the right time to bring joy, along with some practicality, to the road. From quirky kitchen gadgets that make RV cooking easier to tech-savvy tools for people who travel for work, these gifts offer convenience and fun on any adventure.



COLLAPSIBLE TELESCOPING PORTABLE STOOL

\$16.99

For RVers on the move, this compact stool is so easy to carry and set up. Weighing only 2.54 pounds, it's easy to take with you. Use it for tackling quick repairs, chilling by the fire, fishing by the stream, and so much more. The collapsible design makes it easy to stow away in your RV, and with a 550-pound capacity and sturdy build, you'll be ready for nearly any adventure.

Check it out on [Amazon](#) ►



CHEF'N GARLICZOOM GARLIC CHOPPER

\$16.95

Who doesn't want to make meal prep just a little easier? With this small kitchen gadget, all you need to do is load it with garlic, roll it on any flat surface, and, voila, minced garlic without the hassle. The more you roll, the finer the mince. Save space, reduce mess (and odor), and add flavor to campfire and RV meals in seconds. Plus, it's super easy to clean.

Check it out on [Amazon](#) ►





OTOTO AL DENTE PASTA MAN

\$17.99

It doesn't matter if you're boiling a pot of pasta in a luxury kitchen or over a campfire: it's hard to know when the pasta is perfectly prepared. At least, it was in the past. This whimsical spaghetti tester allows you to test noodles to ensure they're ready to eat. As a bonus, not only is it a fun little gadget, but it's also dishwasher safe, food safe, and can be used as a steam releaser.



Check it out on [Amazon](#) ►

RVGUARD RV WATER PRESSURE VALVE

\$24.99

Keeping your RV water pressure just right is easy with this auto-shut-off water regulator. Designed to protect your plumbing system from high-pressure water, it's a must-have for ensuring a steady flow of water at any campsite. Plus, it prevents leaks. It's easy to install, reliable, and provides peace of mind wherever you park.



Check it out on [Amazon](#) ►

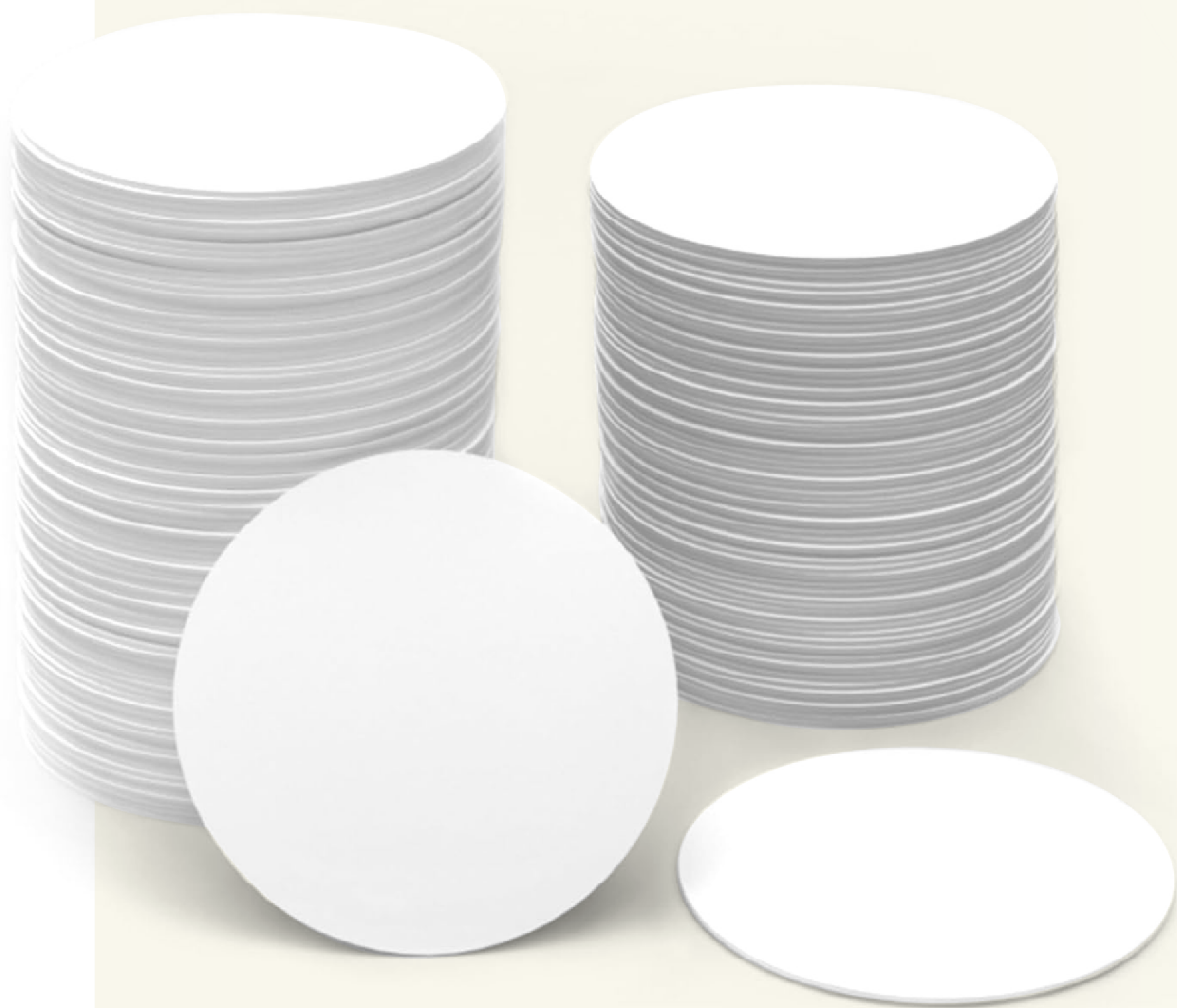

NFC COIN TAGS

\$13.59

These NFC tags offer tech-savvy, gadget-lover RVers an easy way to share WiFi with guests, turn smart devices on or off, or create surprising shortcuts. Just program them with a compatible device to add a layer of convenience and control to your RV.

Check it out on [Amazon](#) ►

PHOMEMO M08F PORTABLE WIRELESS PRINTER

\$136.99

Sometimes, you can't get away from work deadlines. Fortunately, many devices make it easier to get the job done and then

stash it out of sight, so you can relax and enjoy your adventure. You likely already have a laptop. But printers—they're typically so big and bulky. That's why this little inkless black and white printer is a game-changer. Compatible with iOS, Androids, and laptops, it's the perfect complement for printing documents, lists, maps, and more wherever you go. Its sleek, lightweight, thermal, space-saving design eliminates the need for ink cartridges—so that's one more thing you don't have to store! (Just don't forget to pack the thermal paper.)

Check it out on [Amazon](#) ►

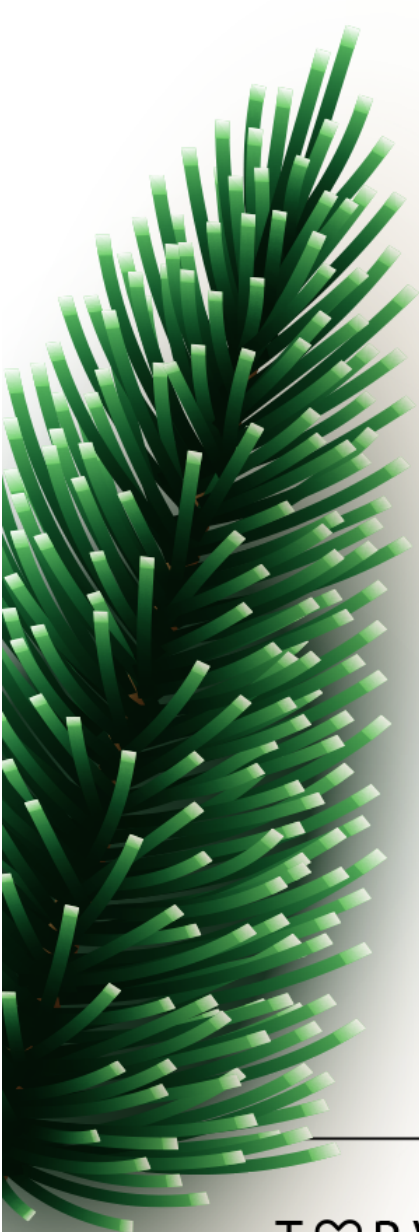



CORDLESS 2-IN-1 SWEEPER WITH BUILT-IN VACUUM

\$79.89

You only have so much space, but you want to keep your floors clean and smooth. Luckily, it just got easier to keep tight RV spaces tidy. Quickly pick up crumbs, dirt, pet hair, and other irritants off the floor and straight into the garbage—without hauling out a vacuum. This lightweight and powerful device makes cleaning a breeze and then easily stores away.

Check it out on [Amazon](#) ▶



This holiday season, give the gift of convenience, tech, or a touch of whimsy to your favorite RVer to make life on the road even better. ❤️

RAISE A GLASS TO FALL ADVENTURES

Celebrating Holiday RV Connections

The holidays are such a magical time of year. Time to connect with loved ones, share cozy moments, indulge in tasty treats, and take in the twinkling lights... and when RVing, you can explore new venues and create new friends along the way.





ACROSS

- 1. Throws softly
- 5. Gather
- 10. Railed public transport
- 14. Hautboy
- 15. Lawful
- 16. Hindu music
- 17. Japanese wooden clog
- 18. Overjoy
- 19. The maple
- 20. Medical
- 22. Partner
- 24. Applaud
- 25. Sea eagles
- 26. Fresh-water fish
- 29. Entertain
- 33. Consume
- 36. Zoologists or botanists, for example
- 40. Pastry item
- 42. Pertaining to the palm of the hand
- 43. Timber tree
- 44. Having God as the focal point
- 47. Arid
- 48. Chemical compound
- 49. Hearing organs
- 51. Mend garments
- 55. Giraffe-like animal
- 59. Primrose
- 61. Shim
- 62. To the sheltered side
- 63. Canal boat
- 65. The Pentateuch
- 66. Member of the women's army auxiliary corps
- 67. Stadium
- 68. Send out
- 69. Australian explorer
- 70. Madagascan mammal
- 71. Valley

DOWN

- 1. Reasoning
- 2. Belief involving sorcery
- 3. Fencing thrust
- 4. Charred
- 5. Smart - , show-off
- 6. Actor, - Gibson
- 7. With mouth wide open
- 8. Indian guitar-like instrument
- 9. Severe
- 10. Send out radio signals
- 11. Sprint contest
- 12. Maturing agent
- 13. Spoil
- 21. Republic in SW Asia
- 23. Trade agreement
- 27. Grotto
- 28. English college
- 30. Second-hand
- 31. Leading player
- 32. Portable ice-box
- 33. Suffix, diminutive
- 34. Exclamations of surprise
- 35. Weight allowance
- 37. Last month
- 38. Uncommon
- 39. Opera solo
- 41. Toecap
- 45. Pack fully
- 46. Harvest
- 50. Moved over ice
- 52. Pertaining to a tube
- 53. Irish county
- 54. Seraglio
- 56. Pueblo Indian village
- 57. Danger
- 58. Angry
- 59. Stage show
- 60. Back
- 61. Scorch
- 62. Reverential fear
- 64. Wildebeest

1	2	3	4		5	6	7	8	9		10	11	12	13
14					15						16			
17					18						19			
20				21			22			23				
24							25							
			26		27	28				29		30	31	32
33	34	35		36			37	38	39					
40			41		42						43			
44				45						46		47		
48								49			50			
			51		52	53	54			55		56	57	58
	59	60							61					
62					63			64			65			
66					67						68			
69					70						71			

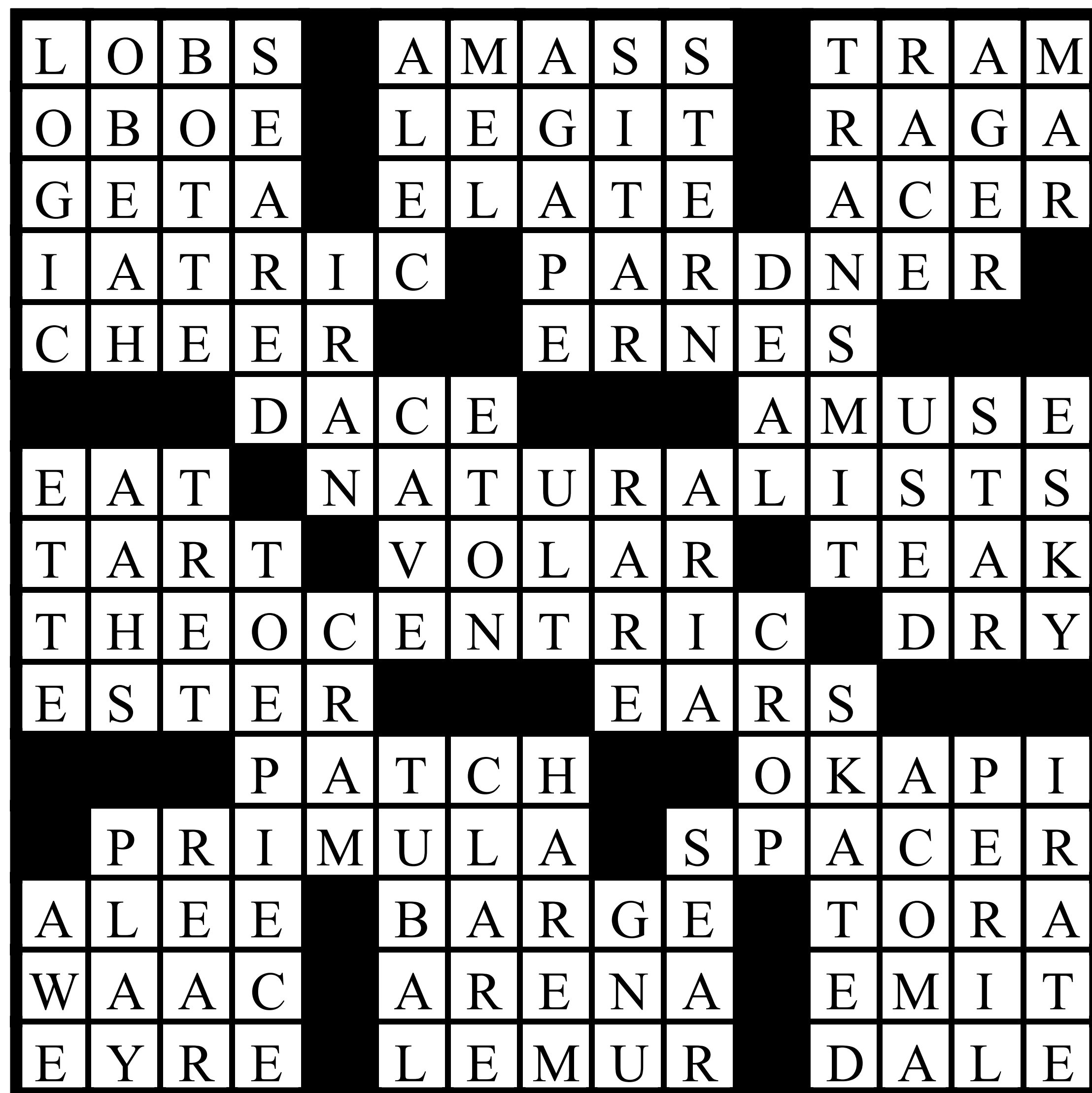



Get 5G on the Road. Fast. Reliable. Secure.

Discover how AT&T enables our fast 5G speeds for customer to download, stream, and share when you're on the road.



Florida RV SuperShow (Tampa RV Show)

Dates: January 15 - 21, 2025

(Industry Days January 15-16)

Location: Florida State
Fairgrounds, Tampa, FL

frvta.org

One of the biggest RV shows in the country! With more than 1,400 RVs on display, this event is perfect for serious buyers, casual browsers, and outdoor enthusiasts alike.

Columbia RV Expo

Dates: January 17 - 19, 2025

Location: South Carolina
State Fair, Columbia, SC

columbiarvexpo.com

Offering great deals on a variety of RVs, the Columbia RV Expo is an excellent stop for those looking to upgrade or explore new camping gear for the upcoming season.

Great Rockies Sport, RV & Boat Show

Dates: January 17 - 19, 2025

Location: MetraPark Expo
Center, Billings, MT

greatrockiesshow.com

Explore the rugged beauty of the Rockies with the latest outdoor equipment, RVs,

and boats at this popular Montana event, perfect for the adventurous spirit.

Tacoma RV Show

Dates: January 23 - 26, 2025

Location: Tacoma Dome,
Tacoma, WA

tacomarvshow.com

Featuring a large selection of RVs from the region's best dealers, the Tacoma RV Show is a must-visit for anyone planning their next big road trip in the Pacific Northwest.

Central Gulf Coast Boat, Sport & RV Show

Dates: January 10 - 12, 2025

Location: Lake Charles Civic
Center, Lake Charles, LA

centralgulfcoastboatrvshow.com

This event brings together top boat and RV dealers from the Gulf Coast, offering great deals and a variety of outdoor products for boating and camping enthusiasts alike.

New England RV Supershow

Dates: January 17 - 20, 2025

Location: Boston Convention
& Exposition Center, Boston,
MA

bostonrvexpo.com

Find your next RV or camping accessory at the New England RV Supershow, where top dealers offer a wide range of products in the heart of Boston.

Quartzsite Sports, Vacation & RV Show

Dates: January 18 - 26, 2025

Location: 700 S. Central
Blvd., Quartzsite, AZ

quartzsitervshow.com

This week-long show offers a massive selection of RVs, accessories, and outdoor equipment, all set against the beautiful Arizona desert backdrop.

Louisville Boat, RV & Sportshow

Dates: January 22 - 26, 2025

Location: Kentucky
Exposition Center, Louisville,
KY

louisvilleboatshow.com

The Louisville Boat, RV & Sportshow is a great

opportunity to explore the latest in RVs, boats, and outdoor gear while taking advantage of exclusive deals and family-friendly activities.

Atlanta Camping & RV Show

Dates: January 23 - 26, 2025

Location: Atlanta Exposition Center, Atlanta, GA

atlantarvshow.com

As one of the largest RV shows in the Southeast, the Atlanta Camping & RV Show offers a fantastic variety of RVs, outdoor products, and family-friendly exhibits.

Ft. Myers RV Show

Dates: January 23 - 26, 2025

Location: JetBlue Park, Ft. Myers, FL

frvta.org

Join the Ft. Myers RV Show for sunny Florida deals on RVs of all types, perfect for snowbirds looking to upgrade.

Oklahoma City RV Showdown

Dates: January 23 - 26, 2025

Location: State Fair Park, Oklahoma City, OK

okcrvshows.com

With a wide range of RVs

and camping equipment, the Oklahoma City RV Showdown is a great place to kick off the new year and plan your next adventure.

Northeast RV & Camping Show

Dates: January 31 - February 2, 2025

Location: Connecticut Convention Center, Hartford, CT

nervshows.com

The Northeast RV & Camping Show offers campers and RVers alike the chance to explore a variety of travel trailers, motorhomes, and camping gear, all under one roof.

Tulsa Boat, Sports & Travel Show

Dates: January 27 - February 2, 2025

Location: Sagenet Center at Expo Square, Tulsa, OK

tulsaboatshow.com

With something for everyone, the Tulsa Boat, Sports & Travel Show features a large selection of RVs, boats, and outdoor products, perfect for planning your next adventure.

Fort Wayne RV & Camping Show

Dates: January 30 - February 2, 2025

Location: Allen County War Memorial Coliseum, Fort Wayne, IN

rvshows.org

The Fort Wayne RV & Camping Show is a local favorite, offering great deals on RVs and showcasing top camping destinations for the upcoming season.

Oregon State - Salem Spring RV Show

Dates: January 30 - February 2, 2025

Location: Oregon State Fair & Expo Center, Salem, OR

salemsspringrvshow.com

The Salem Spring RV Show showcases a wide selection of RVs from local and regional dealers, plus a variety of travel and camping products for all adventurers.

Southeast Texas Boat, Sport & RV Show

Dates: January 31 - February 2, 2025

Location: Ford Park, Beaumont, TX

setxboatrvshow.com

Southeast Texas's premier event for RVs and outdoor fun, featuring RVs of all sizes, plus boats and sports equipment to help you enjoy life on the road and water.

KVAL Sportsmens and Outdoor Recreation Show

Dates: January 31 - February 2, 2025

Location: Lane Events Center, Eugene, OR

[exposureshows.com](https://www.exposureshows.com)

A favorite in Eugene, the KVAL Sportsmens and Outdoor Recreation Show offers visitors a chance to explore RVs, camping equipment, and outdoor gear perfect for the Pacific Northwest.

Nebraska Boat, Sport, & Travel Show

Dates: January 31 - February 2, 2025

Location: Lancaster Event Center, Lincoln, NE

[nebraskasportsshow.com](https://www.nebraskasportsshow.com)

The Nebraska Boat, Sport, & Travel Show is a fantastic event for RVers and outdoor lovers, showcasing RVs, boats, and travel destinations in the Midwest.

St. Louis RV Travel Show

Dates: January 31 - February 2, 2025

Location: America's Center, St. Louis, MO

[stlrv.com](https://www.stlrv.com)

The St. Louis RV Travel Show is a favorite among locals and visitors alike, offering RVs, trailers, and motorhomes, plus accessories and travel ideas.

Iowa RV Show

Dates: February 1 - 4, 2025

Location: Iowa State Fair Grounds, Des Moines, IA

[iarvshow.com](https://www.iarvshow.com)

Head to Des Moines for the Iowa RV Show and see the latest RV models, accessories, and family-friendly camping ideas for your next outdoor adventure.

Jacksonville RV Mega Show

Dates: February 6 - 9, 2025

Location: Jacksonville Equestrian Center, Jacksonville, FL

[frvta.org](https://www.frvta.org)

The Jacksonville RV Mega Show is one of the biggest RV events in Florida, featuring the latest RVs, accessories,

and outdoor gear for road trip enthusiasts.

St. Cloud Sportsmen's Show

Dates: February 7 - 9, 2025

Location: River's Edge Convention Center, St. Cloud, MN

[stcloudsportshow.com](https://www.stcloudsportshow.com)

Get ready for adventure at the St. Cloud Sportsmen's Show, where RVs, boats, and sports equipment come together for a family-friendly event in Minnesota.

Seven Feathers Sportsmen's & Outdoor Recreation Show

Dates: February 7 - 9, 2025

Location: Douglas County Fairgrounds, Roseburg, OR

[exposureshows.com](https://www.exposureshows.com)

This Oregon-based event offers a range of outdoor products, including RVs, camping gear, and more, making it a perfect stop for outdoor enthusiasts in the Pacific Northwest.

Houston RV Show

Dates: February 12 - 16, 2025

Location: NRG Center, Houston, TX

[houstonrvshow.com](https://www.houstonrvshow.com)

One of the largest RV shows in Texas, the Houston RV Show offers a huge selection of RVs, motorhomes, and trailers, along with accessories to help you enjoy life on the road.

Chicago RV & Camping Show

Dates: February 13 - 16, 2025

Location: Donald E. Stephens Convention Center, Rosemont, IL

chicagorvshow.com

The Chicago RV & Camping Show is a popular Midwest event that features a huge selection of RVs, motorhomes, and trailers, as well as camping accessories.

Duluth Boat, Sports Travel & RV Show

Dates: February 13 - 16, 2025

Location: Duluth Entertainment Convention Center, Duluth, MN

minnesotasportshow.com

This Duluth event is perfect for outdoor lovers, offering a great variety of RVs, boats, and outdoor sports equipment for your next adventure.

60th Utah's Sportsman, Vacation & RV Show

Dates: February 13 - 16, 2025

Location: Mountain America Expo Center, Sandy, UT

utahrvshow.com

Utah's longest-running RV show features the latest RVs, travel trailers, and outdoor equipment, offering something for everyone who loves the outdoors.

MHRV Seattle RV Show

Dates: March 6 - 9, 2025

Location: Lumen Field Events Center, Seattle, WA

seattlervshow.com

The Seattle RV Show is one of the Pacific Northwest's largest RV events, featuring the latest models, accessories, and expert advice to get you on the road in style.

70th Annual Ford Indianapolis Boat, Sport & Travel Show

Dates: February 14 - 16 and 19 - 23, 2025

Location: Indiana State Fairgrounds, Indianapolis, IN

indysportshow.com

Celebrating its 70th year, this massive event in Indianapolis brings together

RVs, boats, and travel destinations for outdoor lovers of all kinds.

West Palm Beach RV Show

Dates: February 20-23, 2025

Location: South Florida Fairgrounds, West Palm Beach, FL

frvta.org

The West Palm Beach RV Show features top RV brands and camping gear, perfect for snowbirds and locals looking to upgrade their RVs and explore new travel options.

Dallas RV SuperSale

Dates: February 20 - 23, 2025

Location: Dallas Market Hall, Dallas, TX

dallasrvsupersale.com

One of the biggest RV shows in Texas, the Dallas RV SuperSale offers unbeatable deals on RVs, trailers, and motorhomes, with plenty of accessories to get you road-ready.

Arkansas RV Show

Dates: February 21 - 23, 2025

Location: Statehouse Convention Center, Little Rock, AR

dgattractions.com

The Arkansas RV Show in Little Rock offers a variety of RVs, trailers, and motorhomes, along with travel gear for the perfect outdoor getaway.

Wisconsin RV & Boat Main Sales Event

Dates: February 21 - 23, 2025

Location: EAA Grounds, Oshkosh, WI

rvboatmainevent.com

Wisconsin's RV and Boat Main Sales Event is the perfect stop for outdoor lovers, featuring a great selection of RVs, boats, and sports equipment for your next adventure.

Virginia RV Expo

Dates: February 21 - 23, 2025

Location: Hampton Roads Convention Center, Hampton, VA

varvexpo.com

The Virginia RV Expo features top RV brands and camping gear, making it a perfect event for RV enthusiasts in the Mid-Atlantic region.

Milwaukee RV Show

Dates: February 27 - March 2, 2025

Location: State Fair Park Wisconsin Exposition Center, West Allis, WI

milwaukeeervshow.com

Join the Milwaukee RV Show to check out the latest RV models, trailers, and outdoor accessories for your next big trip across the Midwest or beyond.

Hot Springs Boat, Tackle, & RV Show

Dates: February 28 - March 2, 2025

Location: Hot Springs Convention Center, Hot Springs, AR

dgattractions.com

The Hot Springs Boat & RV Show offers a wide selection of RVs and boats, along with plenty of outdoor gear, all set in the beautiful surroundings of Hot Springs.

Battle Creek RV & Camping Show

Dates: February 28 - March 2, 2025

Location: Kellogg Arena, Battle Creek, MI

michiganrvandcampgrounds.org

The Battle Creek RV & Camping Show is a must-attend for RV enthusiasts in Michigan, featuring the latest RV models, camping gear, and travel ideas for the upcoming season.