

CHASE WARMER WEATHER | ENTER AN RV TIME MACHINE | IMPROVE YOUR SNOWBIRD NEST

# I ♥ RVing

## THE GLAMOR OF ESCAPE

*INSIDE THE BOWLUS  
VOLTERRA AND THE  
ART OF LAND TRAVEL*

▶ *Read Special Feature*

*+ Plus*

**14 Essentials for Cold  
Weather Camping—and  
One Toasty Camp Chair**



Winter 2024

@IHEARTRVING    
IHEARTRVING.COM

SMART  
FLEXIBLE  
CONVERTIBLE



## INTRODUCING EMBERTRACK™

PATENT-PENDING REPOSITIONABLE BUNK/STORAGE SYSTEM



The rear "Do-It-Yourself" cargo area with the EmberTrack™ Bunk/Storage System features two easily removable and repositionable double-bunk composite laminated platforms that can also act as shelves or a desk. A single bunk has a 300# capacity and the double bunk has a 600# capacity. There are also 300# D-ring tie down anchors on the floor. Versatile and adaptable, this system allows customers to change their Ember RV's purpose each trip!



Featured on:

- Overland Series
- Touring Edition
- E-Series



It's time to glow at [EmberRV.com](http://EmberRV.com)

# LESS-LETHAL SELF-DEFENSE



STARTING AT

**\$299.99**

- NOT CLASSIFIED AS A FIREARM
- NO BACKGROUND CHECKS
- NO PERMITS REQUIRED
- OVER 7,000 4.5 STAR REVIEWS

 [BYRNA.COM/RV](https://byrna.com/rv)



## 06 Mirror Check

*A Brief Look at the RV News and Community*

See the latest in the RV world—from cybertrucks, surges in RV shipments, and our favorite posts on social media! Plus, a snowbird soundtrack and RV history quiz.

JUMP TO YOUR FAVORITE SECTION—JUST CLICK!



## 11 American Vista

*Vantage Points of American Beauty*

Dive into the aquamarine splendor of Florida's Biscayne National Park.

## 18 Top Level

*RV Tech and Tradecraft*

The art of land travel is evolving at light speed. Go inside two masterpieces: the Tiffin Midas 24 MT and Bowlus Volterra. Plus, Winter camping's warmest seat.



## 28 Road Abode

*Improving Life on the Go*

Snowbirding is more than location. It's how you show up. Arrive in style with 12 upgrades that will ensure you have the best nest. Plus, top tips for roofing and an RV time machine.

## 41 Edge of the Map

*From the Highway to the Campground*

Big Pine Key RV in Florida's Lower Keys is an all-time camper fantasy. See why its call—one experienced—is impossible to resist. Plus, your next getaway for Spring.



## 51 RVX

*Camping, Adventure, and the RV Experience*

Cold-weather camping? You can't whip Old Man Winter—but you can out-equip him with these 14 essentials. Plus, how to spot a mermaid.

# I ♥ RVing

## I HEART RVING

magazine publisher | **Marc Acton**  
managing editor | **Mark Settle**  
design director | **Brian Harvat**

sales & partnerships director | **Kim Whitaker** (kim@iheartrving.com)  
integrated media sales | **Laurie Zak** (laurie@iheartrving.com)  
Please contact us to advertise with I Heart RVing

content contributors | **Jennifer Adair**  
product manager | **Brent Noble**  
video & social producer | **Nate Kennedy**  
social promoter | **Craig Mitchell**  
email manager | **Jessica Jiron**  
digital marketing specialist | **Larry Norris**  
digital media specialist | **Emily Leavens**  
developers | **Jason Shores, Ralph Aroljo**  
fp&a | **Callip Hall**  
intern | **Lilly Petsolt**

I HEART RVING LLC  
cofounder | **David Petsolt**  
cofounder | **Adam Acosta**

**THANK YOU FOR JOINING US AT THE  
I HEART RVING GLOBAL CAMPGROUND.  
PACK IT IN, PACK IT OUT  
EXTINGUISH ALL FIRES  
SORRY FOR WHAT I SAID WHEN I  
WAS TRYING TO PARK THE RV**

## FINE PRINT/DISCLAIMERS

Copyright © 2024 by I Heart RVing, LLC

Published by I Heart RVing, LLC. I Heart RVing Magazine was founded in 2021 by a crazy bunch of dreamers, story makers, and idea tree shakers who just want to watch the world read.

I Heart RVing makes every effort to provide information that is informative and practical. The publisher, editor, and writers are not responsible for any adverse outcomes or consequences resulting from the use of suggestions or products that appear in this magazine. The acceptance of advertising in this publication does not constitute or imply endorsement by I Heart RVing, LLC (including parent companies, contributors, affiliates or partners) of any advertised product or service. I Heart RVing accepts no responsibility for claims made in advertisements in this publication.

For all subscription updates and inquiries, go to IHeartRVing.com and submit a Contact form with your details. To subscribe to the magazine, visit IHeartRVing.com/subscribe. To submit a story idea, please contact editorial@IHeartRVing.com.

IN THE NEWS

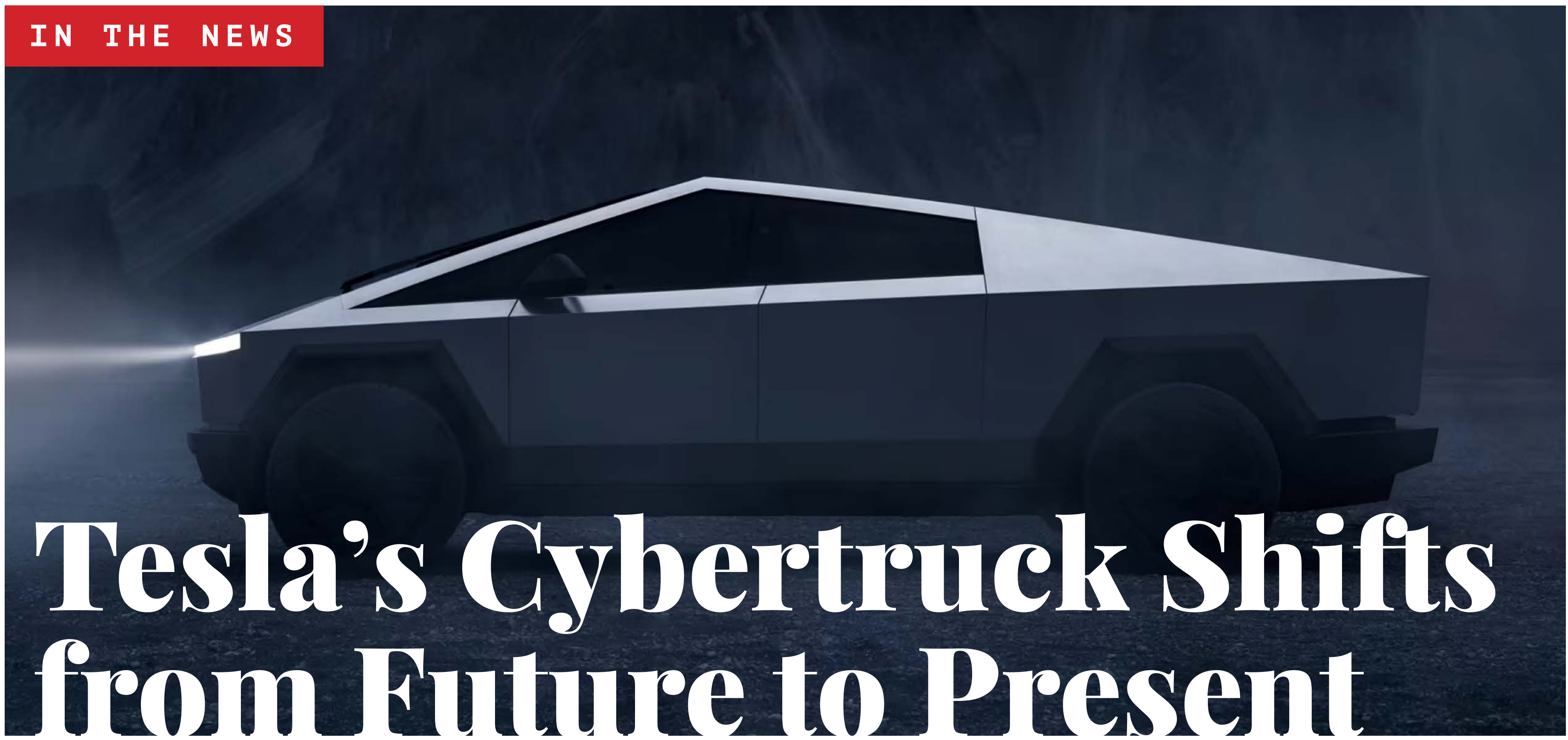

## Tesla's Cybertruck Shifts from Future to Present

**THAT ELON MUSK** is such a tease. Pioneering commercial space flights. Buying up the internet's biggest chatterbox. Promising electric Cybertrucks. Please: Save it for a science fiction novel. We weren't born yesterday. Right?

Maybe not. Like at all. Because things are getting very real with the Tesla Cybertruck.

Last November, reports the Associated Press, Tesla delivered the very first Cybertrucks to customers in Austin, Texas. Which means you could now see one on the road—or even at a campground. Built for any world, the Cybertruck seems plenty ready for this one: Capable of towing up 11,000 pounds; fitted with four-

wheel-drive; rangy to go 340 miles on single charge; and equipped with an instant tent for camping. There's more, too. Way more, and all of it is now in the present. Which begs the question: What else could be coming? Teardrops? Class Bs? Fifth wheels? Yes, please.

**FEAST YOUR EYES ON THE FUTURE**

## Bring. More RVs. On!

RV wholesale shipments are projected to ramp up to 350,000 in 2024, according to RV Roadsigns—a growth trend we can get behind.



**11.8%** to **15.8%**

IN 2024 RV  
WHOLESALE  
SHIPMENTS

## Fort Myers RV Show Rolls into JetBlue Park

View hundreds brand new 2024 RVs of all different types, sizes, and prices at one of Florida's top RV shows. The family-friendly event starts Thursday, January 25, and runs through Sunday, January 28. Admission is only \$10 with children under 16 free. Parking is free courtesy of the RV Trade Association.

[SHOW DETAILS](#)

## KZ RV Connect Mini Named Top RV Debut of 2024

Effortless towing, a luxurious interior, and dozens of top-tier features—all in an ultralight package. What's not to love?

[ZOOM IN TO SEE](#)



## Bowlus RV and Lazy Days Go Steady

It's official-official now. Bowlus has announced that Lazydays will be the exclusive dealer of Bowlus RVs nationwide, making the tandem one of the hottest—and most shiny—power couples in the RV industry. The happy couple has already announced that they're expecting five new dealerships across five states. At each, Bowlus will offer unparalleled white-glove sales and service experience for its luxury product.

[JUMP TO OUR BOWLUS FEATURE](#)

## Time in the Sun

*SNOWBIRD SONGS FOR SUN, SAND, AND THAT DRINK IN YOUR HAND.*

**NOTHING REALLY STICKS IT** to this busy world—or Old Man Winter—like basking in the southern sun. With the RV in park, a drink in your hand, and the good ole boys and gals in tow, you only lack one thing: a beachy soundtrack in the background.

Well, we got you and your Bluetooth speakers covered. Golden oldies, reggae rhythms, and country classics are all just waiting for you to press play.

[PLAY ON SPOTIFY](#)

Get those good vibrations going—from the Beach Boys to Jimmy Buffett. Press the  by the Time in the Sun playlist on Spotify then let the music play.

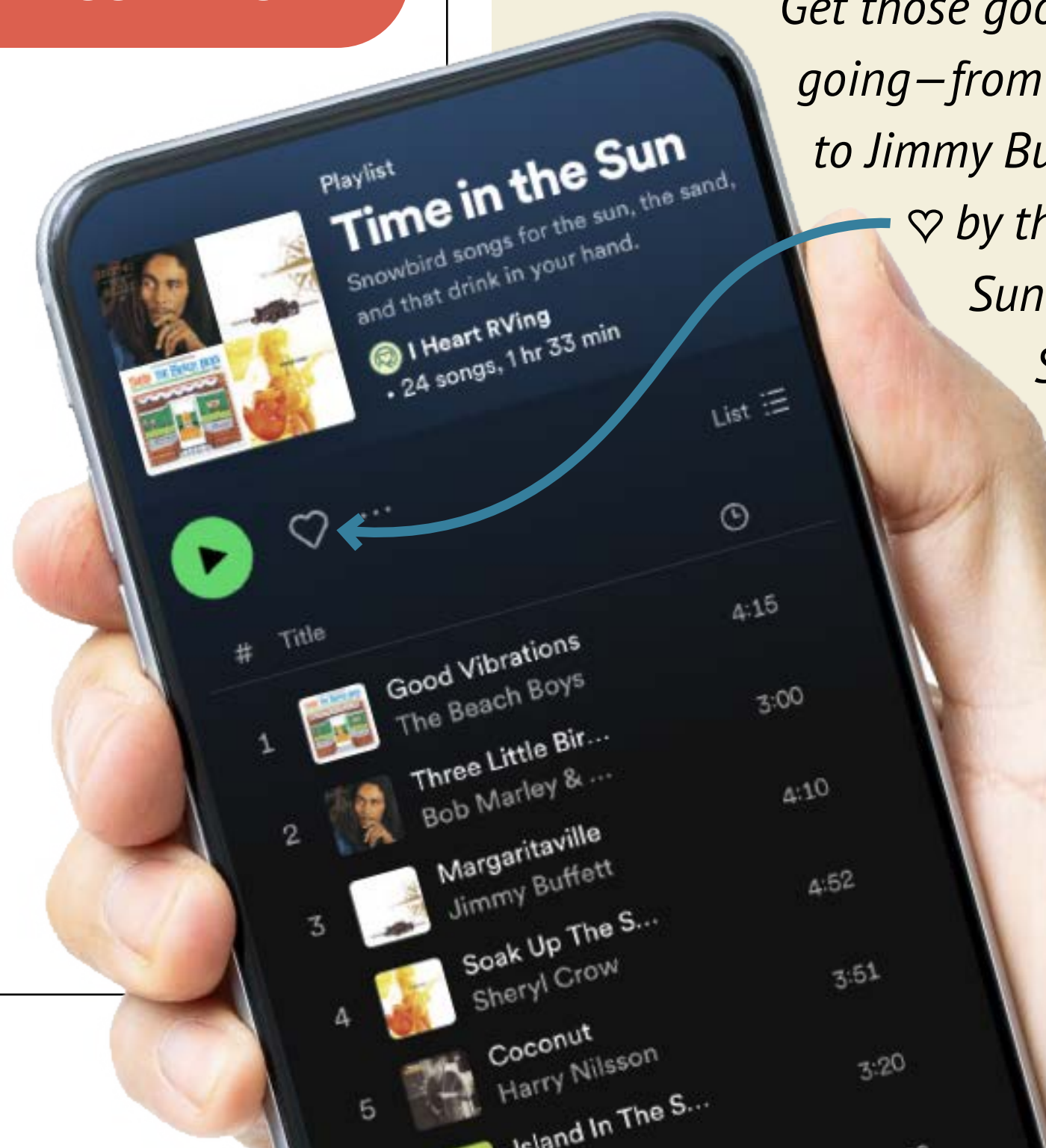

## Scrolling the Virtual Campground

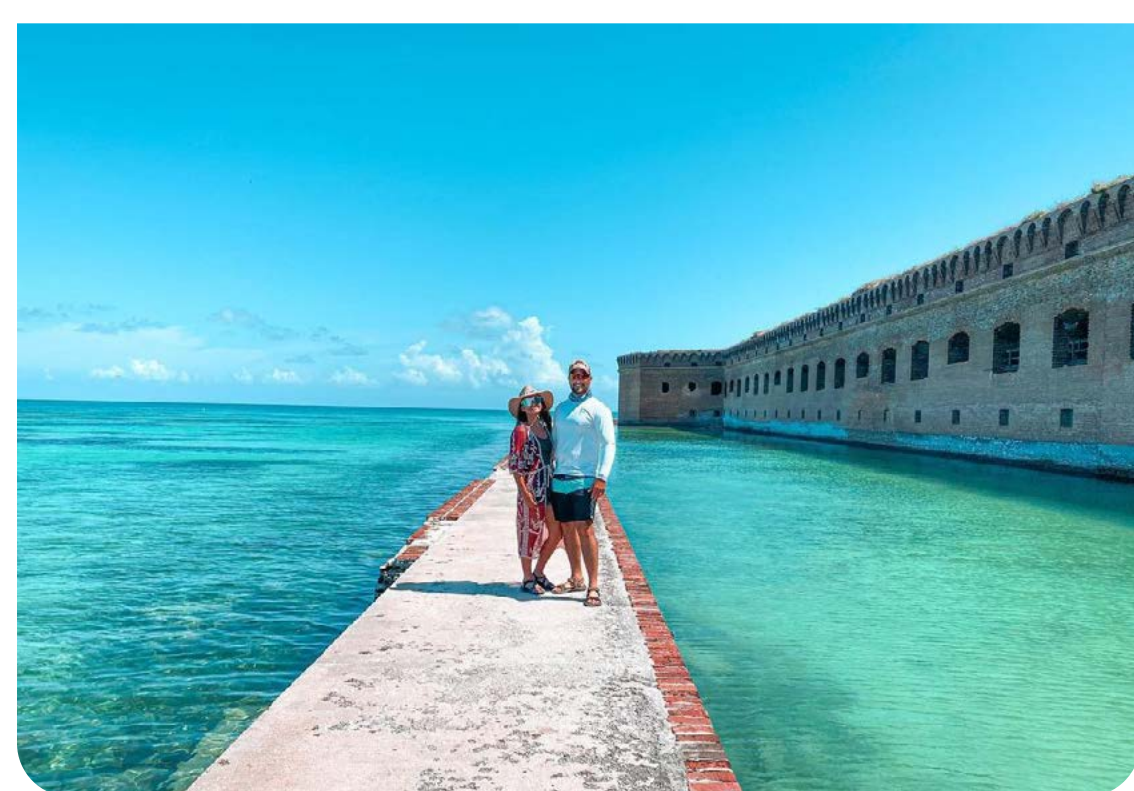

@mountaintop.adventures

**Why We Heart It** Michael and Taylor are a distinct kind of snowbird species—aquatic! When their RV hits the Keys, they waste no time getting in the sun and under the surf.

@lovinthetiffin

**Why We Heart It** There is a magic to Winter camping that's worth a little suffering—if living in a Tiffin can be called suffering at all! (Jump ahead to look at Tiffin's new Midas model!)

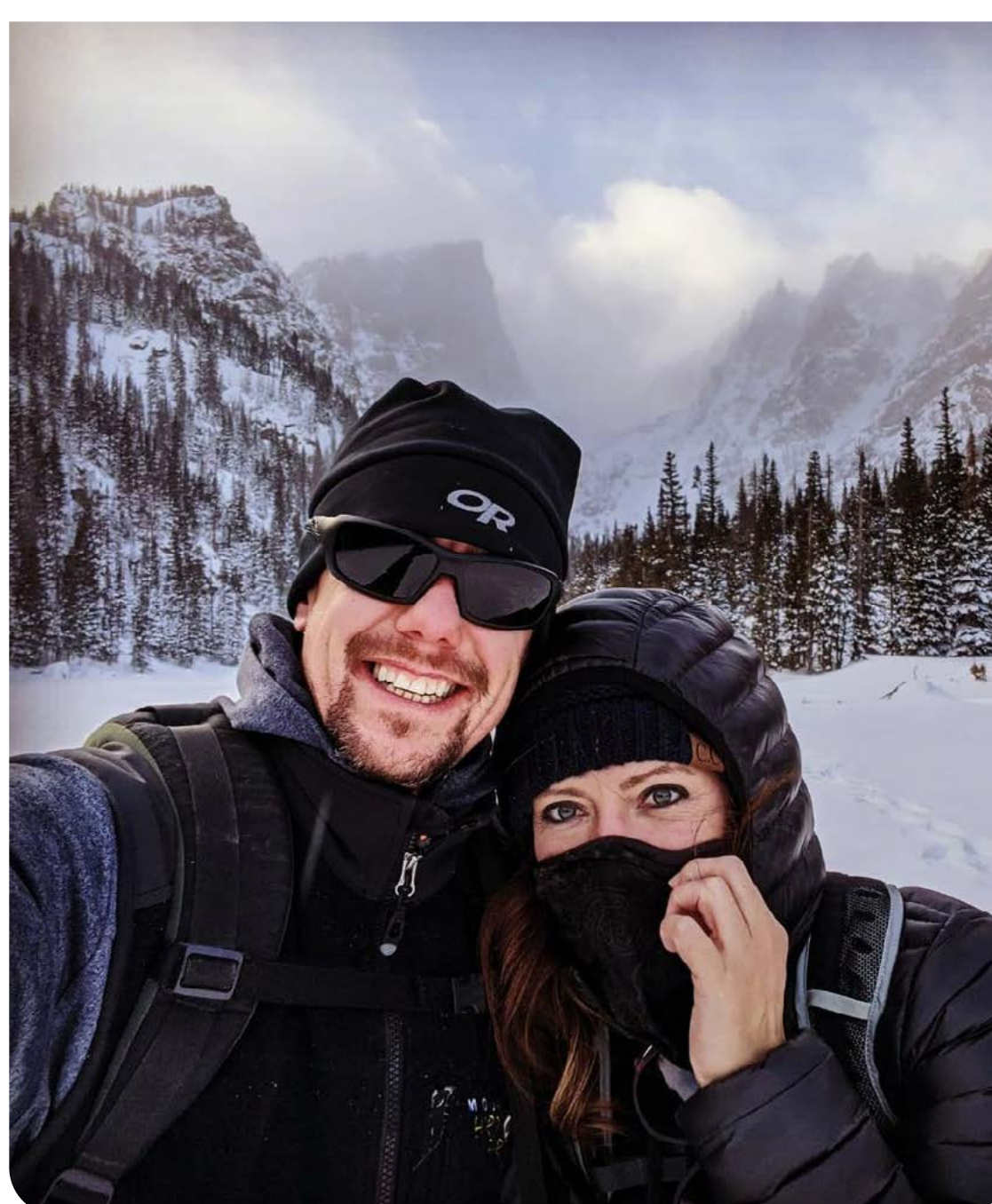

## Most Played TikTok

Hats off to all you cold-weather campers: May the odds be ever in your favor.

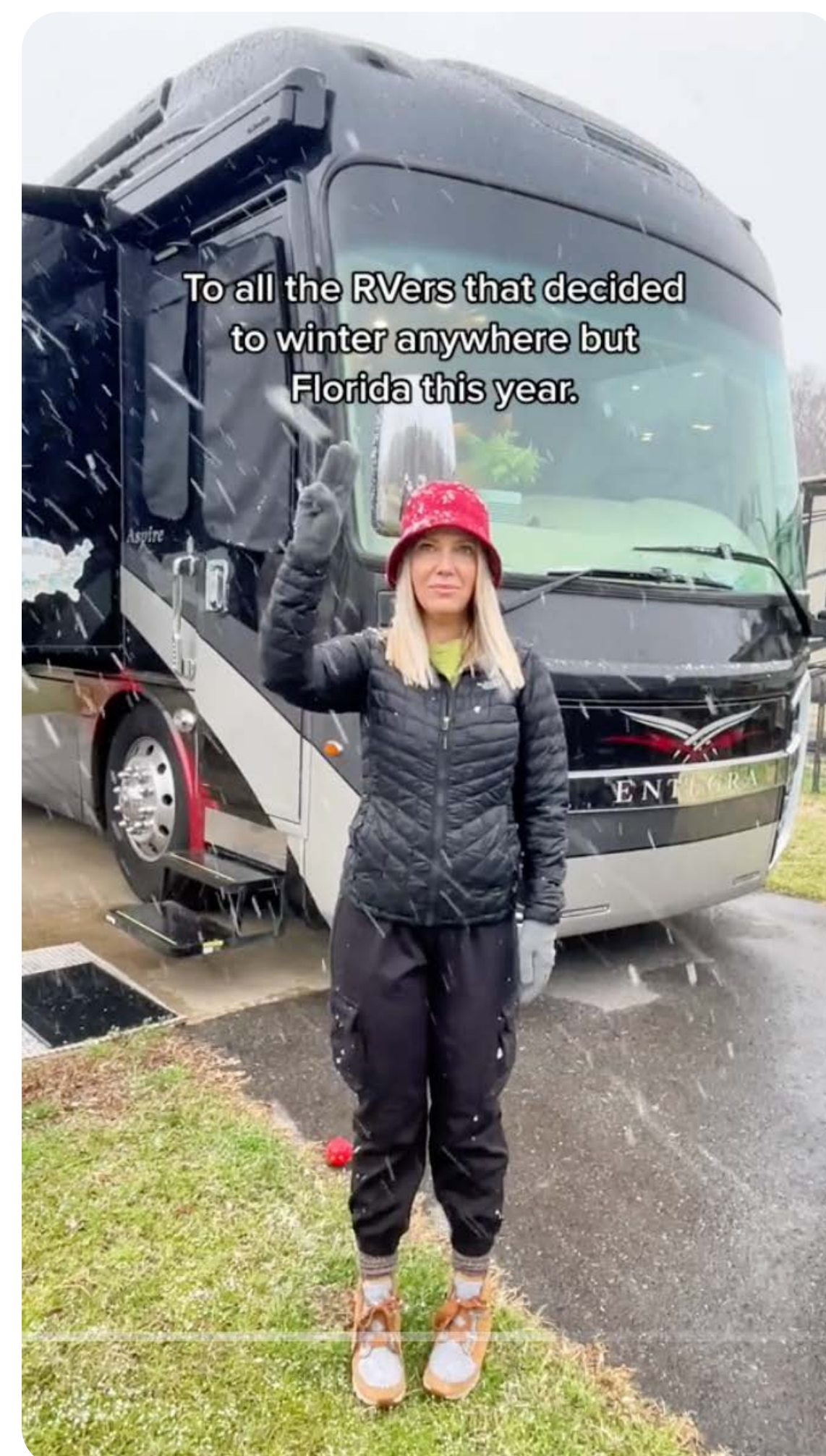

@wandering.routes

“Winter in the RV. #rvlife #nomadfamily #nomadfamilies #rv #snowbirds”

WATCH THE VIDEO

## Jump Into the Fun on Social

Find us on social as we share everything RV—including giveaway offers with great brands. We'll save you a spot at @IHeartRVing on Facebook and @IHeartRVing over on Instagram.



## POP! Take Our RV History Quiz

*THINK YOU KNOW RV  
HISTORY BACKWARDS?  
WE'LL SEE.*

**No. 1**

Between 1915 and 1924, four very famous men, known as the Four Vagabonds, began taking camping trips by automobile. Which man was not one of the Four?

- A.** Thomas Edison
- B.** Henry Ford
- C.** Theodore Roosevelt
- D.** Harvey Firestone

**No. 2**

Until the 1930s, recreational vehicles were only found in the United States.

- A.** True.
- B.** False.

**No. 3**

Which company created the first aluminum-riveted trailer?

- A.** Airstream
- B.** Bowlus
- C.** inTech
- D.** Winnebago

**No. 4**

Which company manufactured the first Class A motorhome?

- A.** Chevrolet
- B.** Chrysler
- C.** Ford
- D.** Holiday Rambler

**No. 5**

Slide-outs were an innovation developed by Fleetwood RV in the 1980s.

- A.** True.
- B.** False

▶ **ANSWERS ON THE NEXT PAGE**

## Quiz Answers:

### No. 1

Between 1915 and 1924, four very famous men, known as the Four Vagabonds, began taking camping trips by automobile. Which man was not one of the Four?

**Answer: C.** *When in doubt, always go with Teddy. Even without a Rough Rider, the Four Vagabonds were an eclectic bunch: Thomas Edison (aka Mr. Lightbulb), Henry Ford (presumably behind the wheel), Harvey Firestone (presumably providing the wheels), and John Burroughs (the nature writer).*

### No. 2

Until the 1930s, recreational vehicles were only found in the United States.

**Answer: B.** *Andrew Woodmansey chronicles how apparently everyone from America to Australia had the same awesome idea as soon as automotives hit the road. [Click here to enter the RV time machine.](#)*

### No. 3

Which company created the first aluminum-riveted trailer?

**Answer: B.** *William Hawley Bowlus—a prolific inventor—gave Bowlus trailers their signature look in 1934, even developing a custom aluminum alloy (Duralumin) for its exterior. Bowlus RV has kept both the iconic look and the spirit of innovation. [Click here to go inside their latest Volterra model.](#)*

### No. 4

Which company manufactured the first Class A motorhome?

**Answer: B.** *Raymond Frank independently started work on “Frank’s Motor Home” in 1958 built on a Dodge chassis. By 1961, Class As were being sold officially under Travco/Dodge and marketed by the Chrysler Corporation. Thus, American roadways entered a new majestic era.*

### No. 5

Slide-outs were an innovation developed by Fleetwood RV in the 1980s.

**Answer: A.** *Heck yeah, it’s true! God bless you, Fleetwood RV. That was a game changer.*

## RV MARKETPLACE

### Major RV Innovation CloZures Shade

Operate without opening the screen or entry door.



Enjoy outside view, control privacy, temp, and light with just a finger slide.

**zarcor.com**

972-380-8724 | 800-877-4797

### RVs Wanted



**RVBUYERSUSA**

WE BUY YEAR 2015–2023 DIESEL  
& GAS - CLASS A, B, AND C'S  
FREE NATIONWIDE PICKUP  
FREE APPRAISAL

email: [RVBuyers@gmail.com](mailto:RVBuyers@gmail.com)  
[www.RVBuyersUSA.com](http://www.RVBuyersUSA.com)

**WE WILL BEAT ANY DEALER PRICE**

# American

VANTAGE POINTS OF AMERICAN BEAUTY

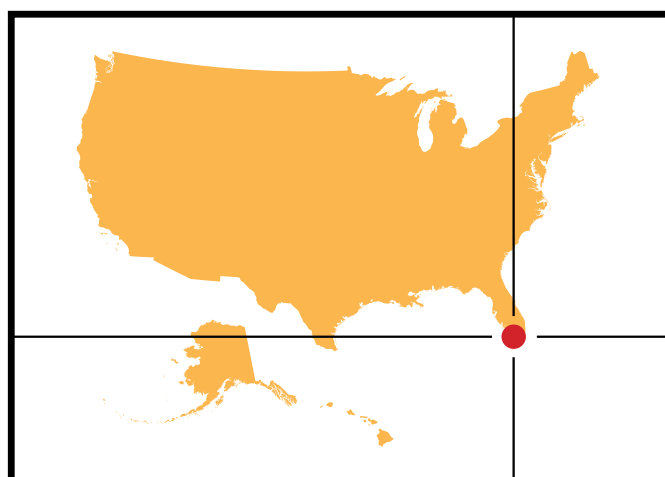

- ▶ BISCAYNE NATIONAL PARK
- ▶ 25°27'52" N, 80°20'05" W
- ▶ FLORIDA
- ▶ [NPS.GOV/BISC](https://www.nps.gov/bisc)

# Vista



**AMONG FLORIDA'S TREASURE ISLANDS** There is an inescapable sense of adventure. Biscayne National Park glimmers like a blue gem in the sun—which you might expect of a national park whose 173,000 acres are 95 percent covered in water. Like a mighty ship pulling into the harbor, here your RV may dock at the Dante Fascell Visitor Center. Once you disembark, you'll soon discover a crystal-clear aquatic playground full of marine life—with nearby islands, like Boca Chita here, just begging you to get your toes (or boat) wet.

# BUILDING DREAMS

*...ONE DETAIL AT A TIME.*



**RECREATIONAL  
VEHICLES**



At KZ, we build RVs that last. Our team of dedicated technicians perform full system checks on all our units, as well as an extensive 300-point inspection on randomly selected units. Our attention to detail is how we make your dream RV a reality. Visit a dealer today and experience the KZ difference.

**(800) 768-4016**

**Go. Camp. Live.**

**KZ-RV.com**

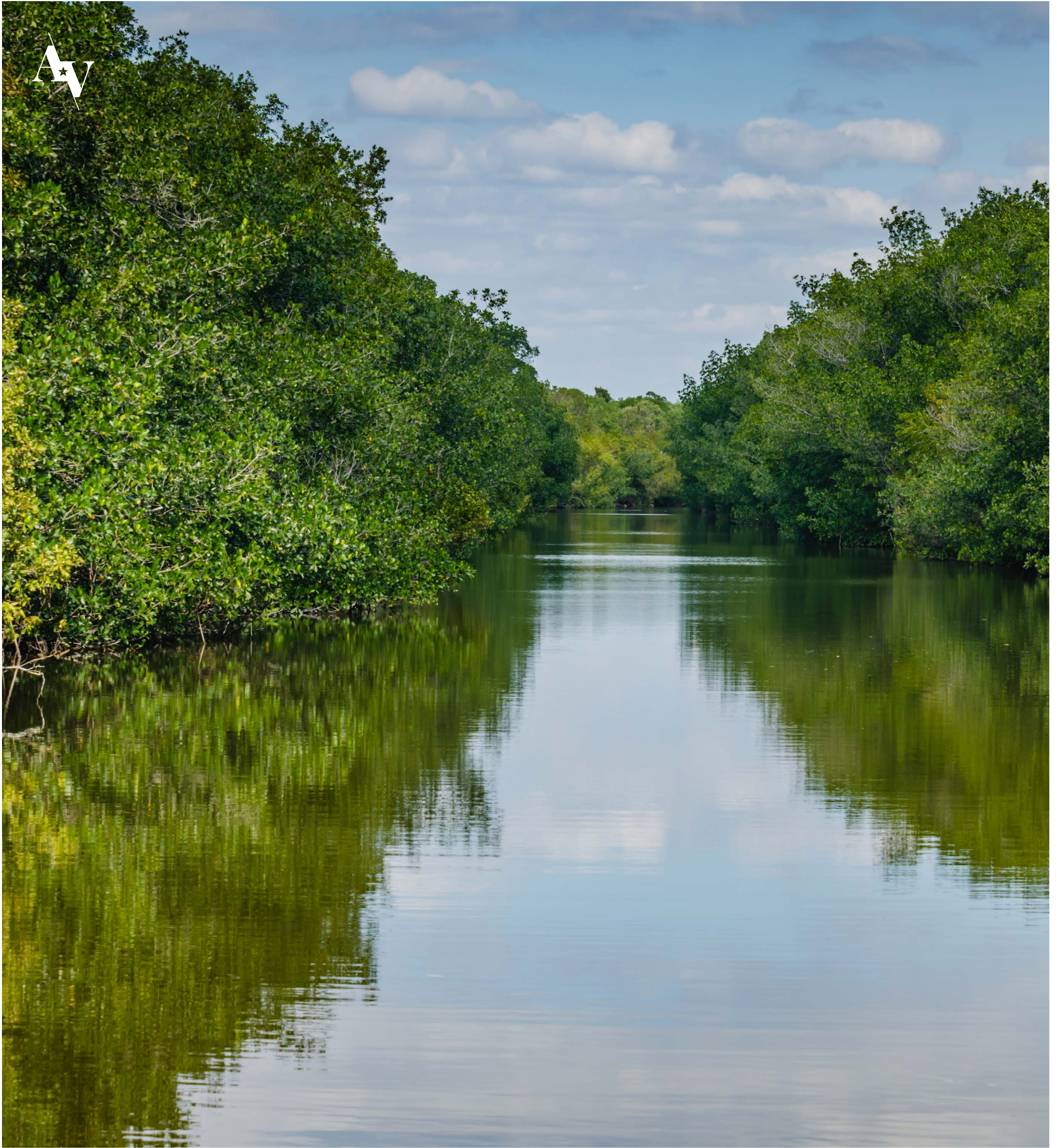

## Paddle Through a Maze of Mangroves.

Toy haulers (or anyone with kayak racks), be advised: You'll wanna bring your good ole rafting buddy as well as your kayak. Paddling among Biscayne's coastal mangroves gives you a very specific feeling—like you're in a movie. There you are! Penetrating the water-tangled roots of a mysterious aquatic forest. Your oar disturbs the green-mirrored surface of the water just outside the lost city of ... Miami.

## Nearest Parking Lot Coordinate

25° 27' 51" N  
80° 20' 09" W





## The Beauty of Boca Chita.

Boca Chita Key is the most visited island in Biscayne National Park. And it's easy to see why. The harbor's iconic 65-foot lighthouse (with an observation deck) stands between the urbane Miami skyline and the immensity of the Atlantic. You have to arrive by boat, but you can camp overnight for a \$35 fee. There's no electricity or drinking water, but there are restrooms and a half-mile hiking trail.

## Nearest Parking Lot Coordinate

25° 27' 51" N

80° 20' 09" W

(Yes, that's the same long-lat.)





## Island Hopping is Encouraged.

Lots of people not named MacArthur enjoy island hopping too. At Biscayne, you can boat-hop uninhabited keys (there are many) or moor into one of the two main islands: Boca Chita Key (the most popular) and Elliott Key (the longest). The crystal-clear waters invite exploration in every direction and angling too—if you’ve got a Florida fishing license and are up to date on the state regs.

## Nearest Parking Lot Coordinate

25° 27' 51" N

80° 20' 09" W

(Uh-huh. Your RV's still in the same spot.)



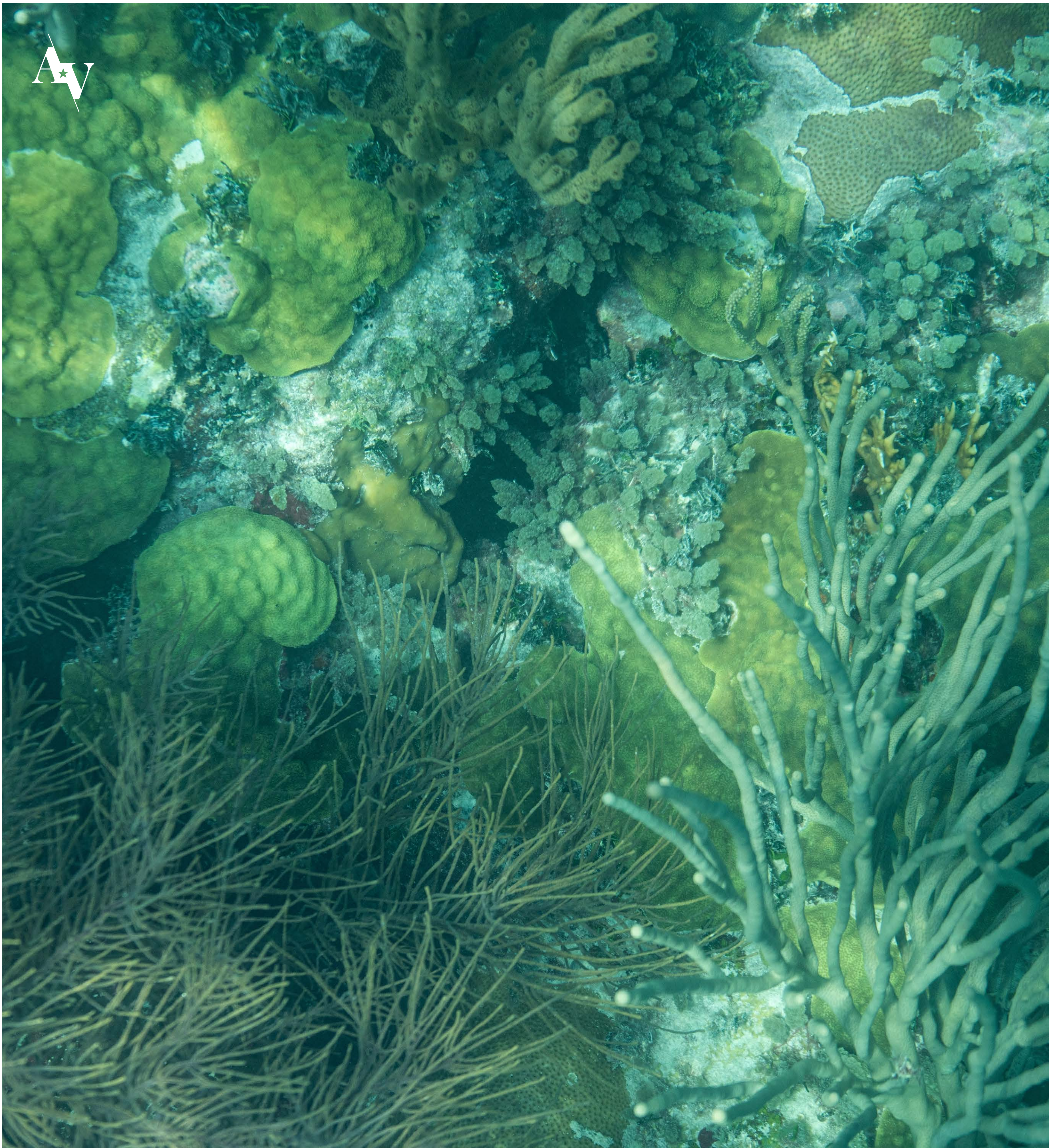

## Snorkeling in a Sea of Shipwrecks.

You might have guessed that what's above water is only half the fun. Biscayne National Park is part of the world's third largest coral reef. Composed of living coral and inhabited by over 500 species of fish, the translucent waters are a kaleidoscope of biodiversity. And there's more below the surface. Both snorkelers and scuba enthusiasts can explore real shipwrecks on the Biscayne Maritime Heritage Trail.

## Nearest Parking Lot Coordinate

25° 27' 51" N

80° 20' 09" W

(We mentioned this place is like all water, right?)



## Alternate RV adventures in a Winter waterland.

*It doesn't really matter which direction you tackle Florida's peninsular plummet. Whether you drive your rig down I-75's Gulf-flanked track or tow your trailer down I-95's Atlantic boundary, you're going to end up on SW 328th Street if you want to enter Biscayne National Park. (The Dante Fascell Visitor Center is just south of Miami, so the park recommends taking the Florida Turnpike to avoid delays.) What does matter is the time of year you arrive. (December through May is best to avoid hurricane season.) The visitor center is open from 9 a.m. to 5 p.m., but local campgrounds, like the Southern Comfort RV Resort, are just a short drive away. But make no mistake, wherever you park is just a launching point into this giant marine playground. Whether you're interested to see the seabirds in the air, manatees among the mangroves, or tropical sea life under the waves, you'll find plenty of reasons to keep your RV parked.*

**“It's definitely another ‘must-see’ if you get the chance!”**

*– Michael and Taylor from @mountaintop.adventures on Instagram*



TOP  
LEVEL



*INSIDE: Cold weather camping, huh?  
Here's how to keep those buns warm.*

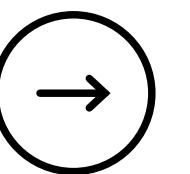

**THE ART OF LAND TRAVEL** is evolving so fast that it almost defies logic. RV technology today is more robust, more complex, and more beautiful than ever before. Want proof? Look no further than Tiffin's Midas 24 MT and the Bowlus Volterra. Every Midas feature has that Tiffin touch—elegant and efficient. And the Volterra puts you in the RV world's first all-electric wonder. Turn the page to see how each is pioneering a stylish new epoch for RVing.

# CONTINUUM™

## WEIGHT DISTRIBUTION HITCH

The whole point of a weight distribution hitch is getting the correct amount of weight moved from the rear axles to the front axles of your vehicle. Current weight distribution hitches take an all-or-nothing approach: loaded or unloaded. Our composite LITEFLEX® bars make it possible to fine-tune your setup with just the pump of a handle.

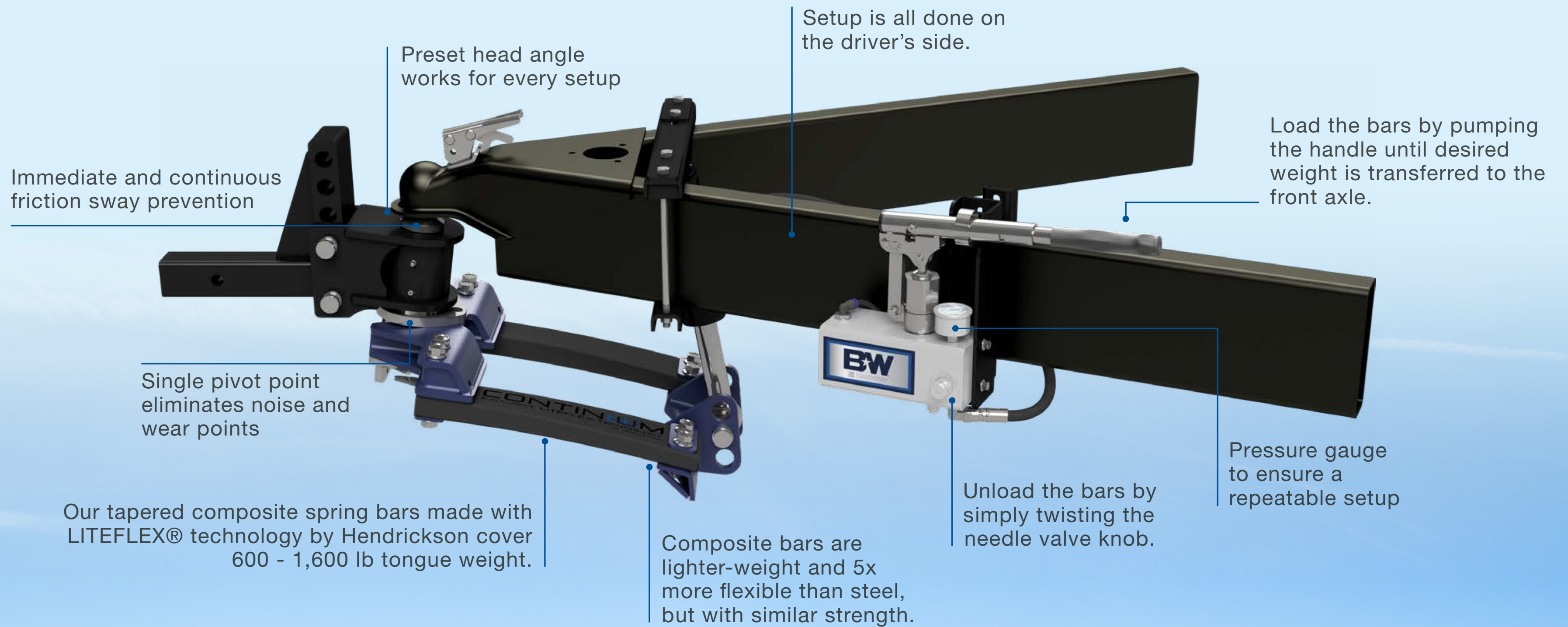

**BW**



## → TIFFIN MIDAS 24 MT

Flush-style tinted windows with tip-out feature

Girard® side-mounted powered patio awning with integrated LED lighting

Heated, electrically adjustable side-view mirrors

Rain sensor for windshield wipers

Lockable handles on compartment doors

Front and rear 205/75R 16C tires

# THE MIRACLE OF THE TIFFIN TOUCH

THE MIDAS 24 MT SETS A NEW CLASS C GOLD STANDARD.

**TURNING EVERYTHING TO GOLD** isn't always a curse. Just ask Tiffin. The Midas 24 MT is an absolute marvel for any Class C enthusiast. Spacious and relaxing, its elegant features abound. Every line falls in pleasant places. And oh, if we haven't mentioned it yet: It drives like a dream.

With all-wheel drive, electric power-assisted steering, and a Ford® 10-Speed Selectshift® automatic transmission with overdrive, the Midas places you in complete command as you mount the cockpit. Handling is as smooth as it is safe. You can enjoy adaptive cruise control, knowing

you're also equipped with a lane-keeping system, TMPS, forward-collision warning, and post-collision braking. All standard.

The Midas 24 MT also affords you every comfort while in park. With just one propitious touch of the thermostat, you can enjoy the perfect climate—no matter the season—behind the pure power of a 20,000-BTU ducted furnace and 13,500-BTU air conditioner. And that's really the idea behind this Class C wonder: the fulfillment of desire in every minor detail. USB receptacles appear in every advantageous spot. The drawers are soft-closing. Quite simply, if Tiffin touches it, it shines.

## AN AMAZING TRANSFORMATION

Moving from the cockpit to the cabin, you can customize how you want to relax—on the sofa or ten toes up on a queen-sized Murphy bed (60-inch x 74-inch). Either way, you'll have extra room courtesy of a driver-side slideout and extra solitude courtesy of your privacy shades.



## KITCHEN FEATURES WORTH THEIR WEIGHT

The Midas 24 MT is a treasure trove of beautiful, handcrafted cabinetry: white linen, sandstone, or shadow (shown here). Solid-surface countertops gild the galley. And then there are the first-class appliances that still manage to optimize space—like the one-burner induction cooktop and the 12-Volt, 8.0-cubic foot refrigerator.

## A PERFECTLY MINTED BATH

Living like a king is a theme that touches every aspect of the Tiffin design. Not least of all the bath. The 34-inch x 34-inch corner shower has an almost invisible economy, as the eye is drawn to its porcelain sink. The sliding glass door. That beautiful skylight. Best of all, its steamy heat—powered by the Truma AquaGo™ Comfort Plus instant water heater—luxuriates the skin.



Experience Class C Wealth.  
Visit [TiffinMotorhomes.com](https://www.TiffinMotorhomes.com)

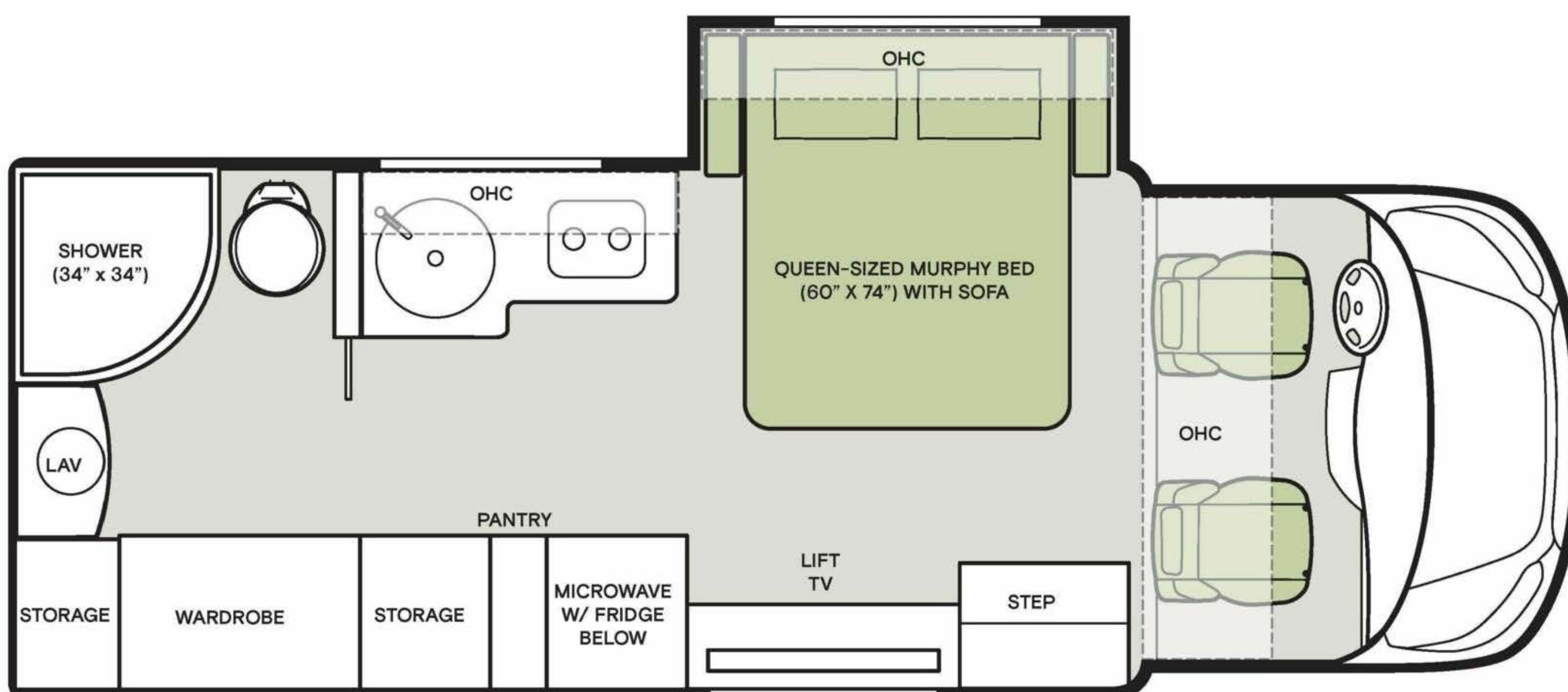

### Tiffin Midas 24 MT Specs:

▶ CHASSIS: FORD 350 HD AWD TRANSIT CUTAWAY	▶ GCWR: 13,000 LBS
▶ ENGINE: FORD 3.5L ECOBOOST 310 HP (GAS)	▶ EXT LENGTH: 24 FT 6 IN
▶ FRESH/GRAY/BLACK: 38/23/22 GAL	▶ EXT HEIGHT: 10 FT 6 IN
▶ GVWR: 11,000 LBS	▶ EXT WIDTH: 7 FT 6 IN



# AN RV AERONAUTICS MASTERPIECE

*BOWLUS VOLTERRA REVEALS  
AN ALL-ELECTRIC FUTURE.  
AND IT'S RIVETING.*

**B**REAKING A BARRIER IS **SEXY**. Always has been, from Lindbergh's Atlantic hop to Yeager's sound-shattering wake. Now, Bowlus Volterra is adding its name to the list of epoch-marking icons by eclipsing the RV obstacle of our age: the electric barrier. And no surprise to anyone, Bowlus is doing it in style.

Pioneering is full of decisive little details. Added up they make all the difference. Exhibit A: weight. The Bowlus

Volterra is ultralight. Which means it requires less power to tow, enabling small SUVs and electric vehicles to tow it. Constructed from aircraft-grade aluminum and then clad in it, the Volterra's riveted sheen is the indistinguishable mark of a trailer built with better materials. Over seventy percent of materials found in the Volterra—from the bronze window screens to the UV-coated birch wood interior—are manufactured by Bowlus.

But the Volterra's power is the true game-changer. It's the world's first all-electric RV. The AeroSolar system charges the Volterra as you drive or while you camp. Its power management system provides a robust 17 kWh of lithium iron phosphate power. The Volterra can even provide an emergency charge for your EV tow vehicle that can extend your range by 65 miles. That kind of electric power in an RV is more than a novelty. It's shocking.



## SEXY, STREAMLINED, SPACIOUS

To enter the Volterra is to experience the awe of its monocoque design. High birch wood panels angle up, widening toward the floor. There, heated floors and radiant heating warm the entire shell (also safeguarding the water tanks from cold weather). Windows are at eye level. Skylights open to the stars. And just prior to the bedroom is a no-odor bathroom and luxury shower with an Italian shower head.



## THE ULTIMATE PRECISION KITCHEN

The Volterra's kitchen is like a Swiss Army knife. That is, if the Swiss Army knife were made by Rolex. There's a 12v fridge (with freezer), two cabinets (including space for a trash can), two large drawers, an (electric-powered) microwave, an (electric powered) induction cooktop. Outlets flank both walls (for extra appliances). The sink has a faucet (which extends). There are even portholes (for natural light).



## BEAUTIFUL BEDROOM GEOMETRIES

Few sleeping environments compare with sleeping in a Bowlus. The Volterra's birch panels are soft but warm, and glow with mellow daylight drawn from the world outside. Twin beds make a romantic arc that draw sleepers toward a shared foot space, but the bedroom can also convert into a king-sized bed to engineer an even more intimate geometry.

Charge into Your Electric Future. **Visit [Bowlus.com](https://www.bowlus.com).**



### Bowlus Volterra Specs:

▶ LENGTH: 27 FT 2 IN	▶ BASE WEIGHT 2,500 LBS
▶ HEIGHT: 8 FT 6 IN	▶ HITCH WEIGHT 300 LBS
▶ FRESH/GRAY/BLACK 50/31/4.5 GAL	▶ GVWR 4,000 LBS

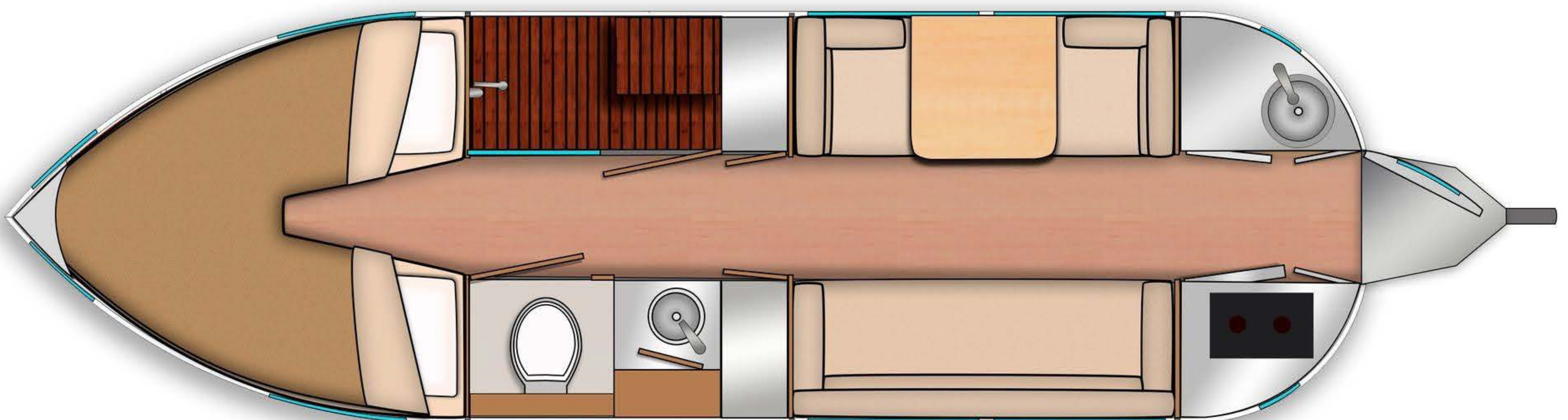

# Gobi Terrain Heated Camp Chair

BY N8 KENNEDY

*TESTED IN ICE-COLD CONDITIONS, THIS HEATED CAMP CHAIR KEPT OUR BACKSIDES AS WARM AS FRENCH TOAST.*

## BOTTOM LINE UP FRONT:

→ **WE WANNA BE WARM**, but Winter can make a mockery of our attempts to stay warm while camping outdoors. (See [what we mean](#).) But Gobi Heat's terrain heated camp chairs make sitting by a campfire the joy it should be—no matter what the thermostat says. We took these chairs out into some of the country's coldest places, like Wisconsin and Minnesota. Flat-out: These chairs are comfortable for any season. But in the cold? Oh, baby! The battery gives you hours to enjoy the best seat in the wintriest outdoors—a seat you can actually relax in.

## FEATURES WE LOVE:

### Heat That Lasts

*We can't say enough about the 7.4V 6500 mAh battery. It powers two heat zones across three settings, and even doubles a phone charger.*

### Light and Easy

*At just 11 pounds, the Terrain is one of the lightest chairs on the market, and storing is easy with an oversized bag. It eliminates the usual struggle.*

### Sturdy as Steel

*The Terrain is built with a solid, collapsible steel frame and 600/300 Denier Polyester. It handles all four seasons and holds up to 325 pounds—great for campfires with a kid on your lap!*

### Nice Little Touches

*Keep your favorite beverage close on one side with the cup holder and your phone zipped—charging—on the other, where the LED controller is just a flick of a finger away.*



**WATCH N8 SIT IN SNOW—COMFORTABLY.**

See the full review on YouTube. →



*Keep that backside toasty.*

Buy at [GobiHeat.com](http://GobiHeat.com)

# Road Abode

IMPROVING LIFE ON THE GO

## All the Stuff You Need to Winter in Style



*INSIDE: Your top options for  
roof repair and replacement.*

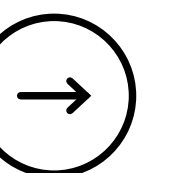

**MIGRATION MEANS MORE THAN TRAVEL.** It also means enjoying life in your RV, wherever you land. So for your Winter nest, you'll want to gather the best materials to make your southern swing an absolute pleasure—whether at the tiki bar, in the boondocks, or just chilling in your cabin. In our feature, we share 12 upgrades that can make all the difference.

You're always  
at home here.



They say that home is where the heart is. Maybe that's why so many people have fallen in love with Big Pine Key and Florida's Lower Keys. As home to two wildlife refuges, epic ocean views, miles of unspoiled wilderness and everything from cozy campsites to luxurious RV parks, and Stock Island's delightful restaurants and rustic charm, Florida's Lower Keys should be at the top of your vacation list.

[fla-keys.com/lowerkeys](http://fla-keys.com/lowerkeys) 1.800.872.3722





# The BEST Nest

**12 UPGRADES TO TAKE YOUR RV UP A LEVEL,  
EVEN AS YOU HEAD DOWN SOUTH.**

## EVERY HOME HAS TO FIND THE RIGHT BALANCE

between contentment and improvement. Especially mobile ones. At least, so P.D. Eastman tells us. When the author-illustrator penned his 1968 children’s classic, *The Best Nest*, he made a simple case: If Mrs. Bird isn’t happy, no one is.

Really, regardless of which party is unhappy (it could be anyone), the problem boils down to two things: Finding the right spot ([see Big Pine Key RV](#)); and getting all the right stuff. To make your new campsite perfect, your RV may not need the same things that Mr. and Mrs. Bird needed—“all the hay, all the

straw, all the string, all the stuffing, all the horse hair, and all the man hair”—but making some key upgrades to your RV can make a massive difference in your snowbirding experience.

So, take a look at a dozen items we recommend to help make your RV the best nest—for everyone involved.



# Give Your POWER a Little Lift

CLICK PRODUCT NAME  
TO START SHOPPING.



## « RELION LIFEPO4 BATTERIES

If you're gonna be using electronics all Winter (you are), why not go for a battery upgrade (lithium iron phosphate) that is safer and has more cycles. You know, one you can RELiON.



## GO POWER! SOLAR CHARGING KIT »

You don't have to go full solar to soak in the benefits. Even using a solar kit as an auxiliary, you'll extend battery life, reduce energy costs, and have reliable backup power in an emergency.



## « TRANSFER FLOW AUXILIARY FUEL TANK

Just because you've swapped to a more southerly campsite doesn't mean you've given up on road trips. Far from it. Give your pickup some extra range with this auxiliary fuel tank and enhance that I-go-where-I want thing you've got going.

# Interweave FUN with Function



## ◀◀ MAGNESHADE (CUSTOM!)

Down south, you're gonna get more sun. And so is your RV. Help protect your cabin's temp with these easy-to-apply shades (simple as magnets) that can block over 90 percent of harmful UV rays. Plus, you can even design them custom!

## EQUATOR STACKABLE LAUNDRY CENTER ▶▶

You're heading south to get away from the cold. And away from frustrations. Don't let your laundry setup be one. Equator's stacked, front-loading unit will speed up your clothes cycle, while slowing down your stress cycle.



## ◀◀ BAUER NE BLUETOOTH HANDLES (KEYLESS!)

Think you're gonna be going inside and out a bunch while you're full-timing in Florida? (Hint: Yes, you are.) Bauer's bluetooth makes entrance as easy as the push of a button.





## ◀ BEE GREEN LED LIGHTING

Better lighting in your RV makes a big difference on how much you enjoy your cabin. Upgrading to Bee Green LEDs is like renovating everything their earth-friendly, evenly-distributed light touches. Plus, you can install reading lights with USB charge ports. (And did we mention the green they'll save you on energy?)

## WINEGARD CONNECT ROUTER ▶▶

Some of these snowbird joints are pretty swanky. And others—while still awesome—are pretty rustic. Either way, you're gonna wanna give your Wi-Fi a boost to maximize your speed and extend your range.



## ◀ BEDDY'S ZIPPER BEDDING

You make your bed every day. (Don't you?) Well, in your RV, that's always a pain. But Beddy's has put an end to that. Level-up the ease—and minky-soft-microfiber comfort—with their zipper bedding.



# Flaunt a few FRIEND-MAKERS



## ◀ NINJA BL660 BLENDER (FOR MARGARITAS!)

Campground life is about people. Community. Being social. Well, nothing makes friends faster than, “Want a frozen margarita?” Hope you handle popularity well.

## STARLINK ROAM ▶▶

Starlink service plans connect you with high-speed internet almost anywhere across the world. Which is awesome. But you’ll also find that your Starlink setup ([like the one that comes with Bowlus Volterra](#)) is a big-time conversation starter. Boy, folks love to talk about Elon ([take a look](#)).



## ◀ TRAEGER RANGER PORTABLE GRILL

You’ve already got your frozen margarita maker. Now you’re throwing a Traeger wood-pellet grill into the mix?! Digitally controlled and able to dispense that smoky wood-fired taste to every morsel you throw on it, you might attract a whole flock of fellow snowbirds to your nest—which, based on everything we’re reading about your setup, just might really be the best.





# FACING THAT MOMENT OF ROOF

# 4

SIGNS TO MAKE REPAIRING OR REPLACING YOUR RV ROOF A TOP PRIORITY.

BY JENNIFER ADAIR

**L**et's all agree on a universal truth: RVing gives adventure a whole new ceiling. Our RVs transport us to nature's grandest backyards and still give us the comfort of home. Chief among those comforts is having a roof over our head. So, when we start to see signs that our RV roof may need maintenance, it can be a real downer. We may not want to see what we see. (That's denial.) But if we want to keep enjoying our RV (we

do), we need to accept a hard truth: Repairing or replacing our roof is key in preventing costly water leaks and damages.

Fortunately, you can restore your roof integrity and all the fun that comes with it. You may even end up with a far better roof. (More on that in a bit.) So, be encouraged. No matter what you might hear from Jack Nicholson, you can handle the roof. And here's how.

# 4 SIGNS TO LOOK FOR

*What color changes, cracks, caulking, and wrinkles might mean.*

If you want your RV to stand the test of time, it's essential to catch potential roof issues early. So keep an eye out for these signs. Regular inspections (before and after trips) help you catch problems early because you will be able to spot changes in how your roof looks or feels.

Visually, the roof should be smooth and lay flat. There should be no cracks or tears in the roofing material. If you have an EPDM (ethylene propylene diene monomer) rubber roof, it should be white. The roof material is half white and half black. Once the white wears away from UV exposure and time, you'll see the black. And that is a visual indicator you need to replace the roof.

TPO (thermoplastic polyolefin) or vinyl roofs should also lay flat. Wrinkles (due to the way this roof type is adhered) usually indicates water intrusion. The cotton backing of these roofs soak in water and hold it in,

which can lead to wood rot in a short period of time. While some wrinkles from stretching are common in both types of roofs, they will usually be in a straight line along the plywood. Fiberglass roofs should be inspected for small spider cracks in the surface. As the gel coat deteriorates, the fiberglass is exposed and will start to crack. If you notice white streaks on your sides, this is usually from the gel coat deteriorating.

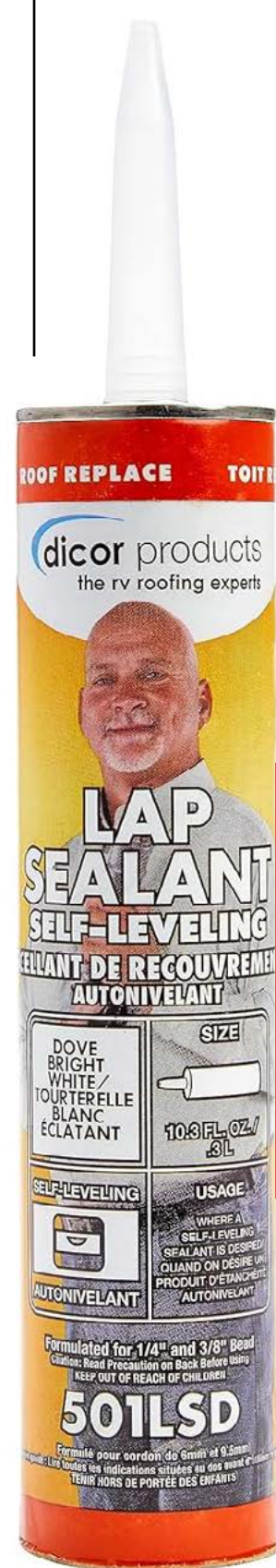

**DICOR SELF-LEVELING  
LAP SEALANT, \$12.21**  
*on Amazon.com*

Ultimately, though, the No. 1 offender of water damage in an RV roof is bad caulking. You should inspect this regularly for cracks. Once it dries out and cracks, you are just waiting for a leak. Self-leveling sealant (the most common one is made by Dicor and compatible with EPDM) stays soft and supple. Regular inspection is your best way

to find and address problems early before it results in a costly repair.

# FACTORS TO CONSIDER

*Finding out just how bad your RV roof really is.*

When dealing with RV roof problems, start by gauging the extent of the damage. If you notice only chalking and the overall condition of your roof is good, a rubber conditioner or silicon coating can effectively fix the problem and prolong the lifespan of your roof's membrane.

However, if water has infiltrated the roof, quick action is needed to prevent further damage. To ensure the long-term health of your RV, take note of any holes in the rubber, as they play an important role in deciding the next steps for comprehensive roof maintenance.

Luckily, there are several options to consider when dealing with a leaky RV roof.



## WEIGHING YOUR OPTIONS

Products for roof repair and your best option for replacement.

For minor issues (especially if you are a do-it-yourselfer), a rolled-on silicon or rubber coating can safely preserve the existing material. Liquid Rubber, Hengs, and other rolled on options can be found at your local RV store. Before patching small membrane holes using products like EternaBond tape, make sure the wood underneath is dry before application.

However, larger holes or soft spots call for a comprehensive roof replacement to address the problem properly and prevent larger issues down the road. When it comes to replacing the roof membrane, the common approach is swapping it with the same type at any RV service center or dealership.



However, this method may not fully eliminate all of your membrane concerns. Another option is aftermarket installations, usually done more carefully than factory installs. But, they might take longer, causing a costly delay. The truth is that all this trouble might have you looking for a permanent solution, and in that category, none can match a sprayed-on RV roof.

## ENJOY AN EVEN BETTER ROOF

Spray-on roofing means no leaks for a lifetime.

A sprayed-on RV roof, like FlexArmor, is made to address the common issues with standard RV roof options. FlexArmor was designed to remove the caulking seams, provide unparalleled durability, superior insulation, and maximum impact protection, ensuring your RV roof stands the test of time. Plus, FlexArmor RV roofs stick to your RV to create a strong seal that lasts a lifetime. That means no leaks. Ever. Guaranteed.



At FlexArmor, our goal is to offer the best RV roofing solution in a crowded market, and we've been doing so successfully for over 16 years. Our commitment revolves around three simple



**LIQUID RUBBER EPDM PRIMER (1 GALLON), \$79.95**  
on Amazon.com



principles: no leaks, no maintenance, no worries.

FlexArmor stands out as an aftermarket option because it provides a seamless RV roof with no caulking, unlike other standard RV roof options. FlexArmor roofs are also typically three times thicker and stronger. This means better insulation and more protection from bumps and knocks. When you have a monolithic roof with no seams to maintain, you eliminate a major worry.

How does FlexArmor do it? Unique bonding techniques

# FlexArmor

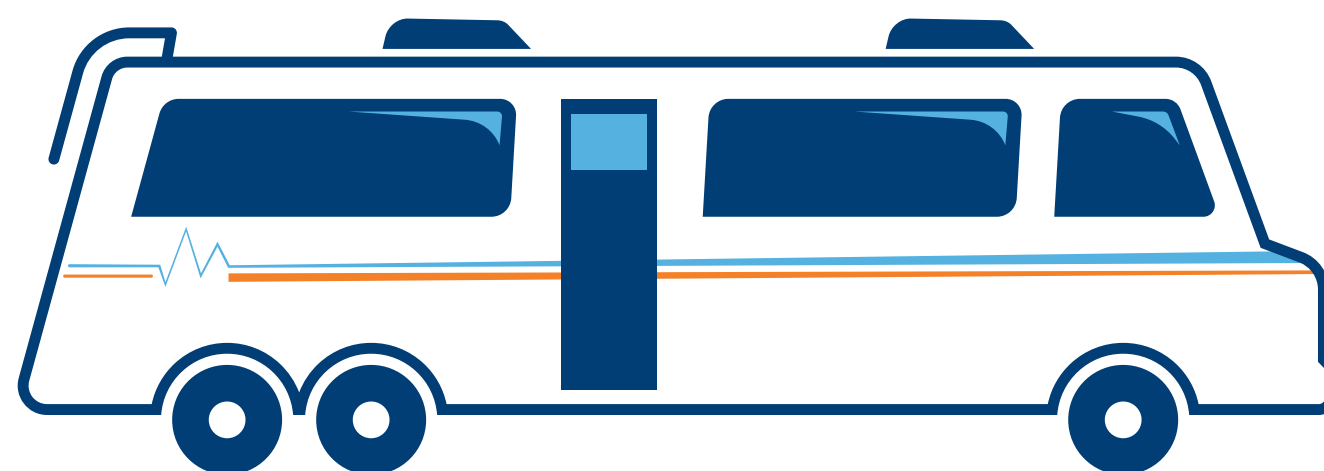

The ORIGINAL Sprayed RV Roof

**GET YOUR FREE FLEXARMOR SAMPLE**

at [RVRoof.com](http://RVRoof.com)

even after years of travel.

Since every RV roof is different, we customize our process to fit various situations. Whether it's a quick two-and-a-half-day appointment or a straightforward one-page warranty, FlexArmor isn't just a roof solution; it's a reliable promise for worry-free RV journeys. So you can always trust the roof over your head, wherever adventure takes you.

[Get Your Free FlexArmor Sample at RVRoof.com.](http://RVRoof.com)

You can see the thickness and durability for yourself.

that stick well to all sorts of materials on RV roofs, forming the basis for our lifetime, transferable, no-leak guarantee. We're confident these bonds won't weaken



# Quick! To the RV Time Machine!

**WE MIGHT BE FORGIVEN** for looking to the future. (Heck, did you see that Cybertruck?!) Or for standing in awe of the present. (We could stare at the Bowlus Volterra for hours ... and may already have. Ugh, lost track of time.) But to hit rewind and play back the tape

of our RV ancestors? That's something we've never been able to do. At least, not the way Andrew Woodmansey does it in his new book, *Recreational Vehicles: A World History 1872-1939*.

Woodmansey's book is so good that—can't believe we're about to say this—it

makes us miss coffee tables. It's beautifully printed, richly illustrated, and almost impossible to put down. (Apparently time travel is addictive.) But there are three big things about this visual history that we're particularly wild about. So here we go.

BUY YOUR  
COPY NOW ON AMAZON**RECREATIONAL  
VEHICLES**

A WORLD HISTORY 1872-1939

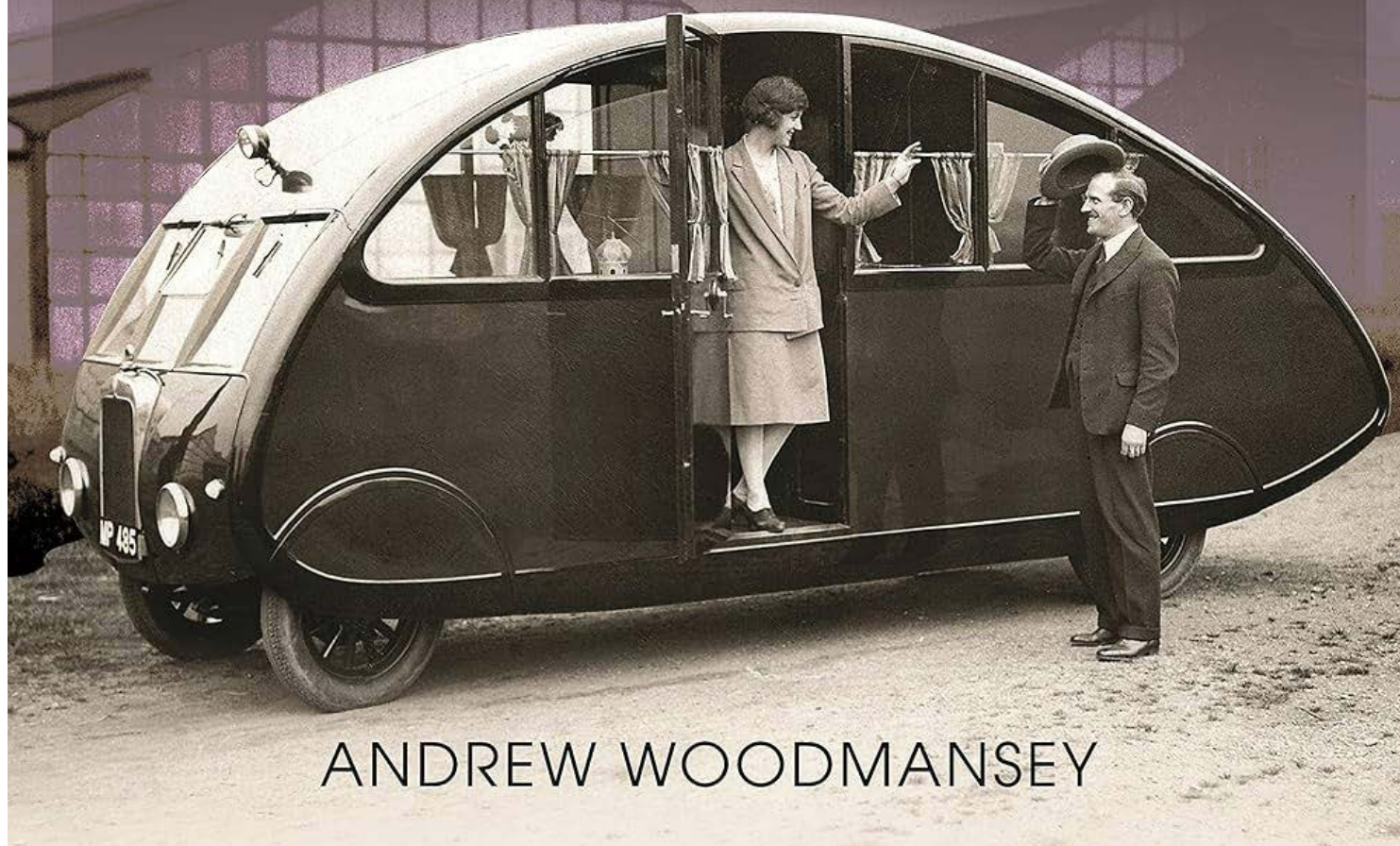

ANDREW WOODMANSEY

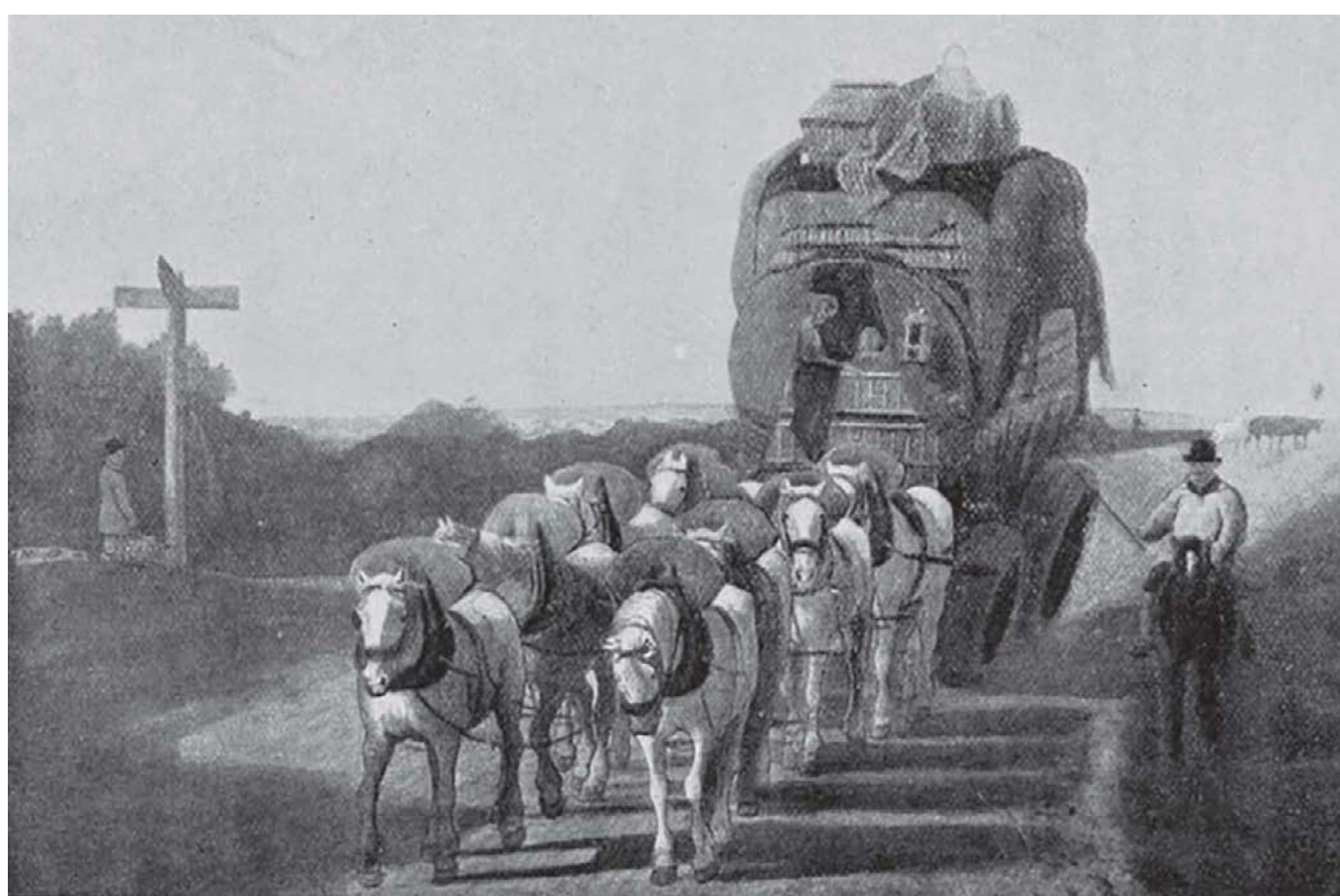

# Our 3 Favorite Things

## 1 COUNTLESS PICTURES OF A LOST RV AGE

Credit Pen & Sword Books for going all-in with this picture-heavy history. The innumerable period photos make it an absolute page turner. From the Dupont Camping Auto to the Airstream Silver Bullet, the weird models and surprisingly familiar innovations make it a visual feast for any RV enthusiast.

## 2 A PORTAL TO THE OTHER SIDE OF THE RV WORLD

We'd have guessed that the ole U.S. of A. was the birthplace of the RV and that the rest of the world has been playing catch-up. (Like disco, right?) Wrong. RVing has been a global phenomenon almost from the get-go. Woodmansey tours its incredible, simultaneous evolution in Europe, Australasia, and the U.S.

## 3 AMAZING STORIES WE NEVER KNEW ABOUT

Woodmansey is not only a prodigious researcher (no telling how many hours he poured into this book); but he's also a storyteller. Did you know that a doctor's weird (but awesome) prescription to go camping in 1894 launched one of the first RV influencers (the Lasleys)? Us either. This book is rich with fun camper trivia.

# EDGE OF THE MAP

FROM THE HIGHWAY TO THE CAMPGROUND

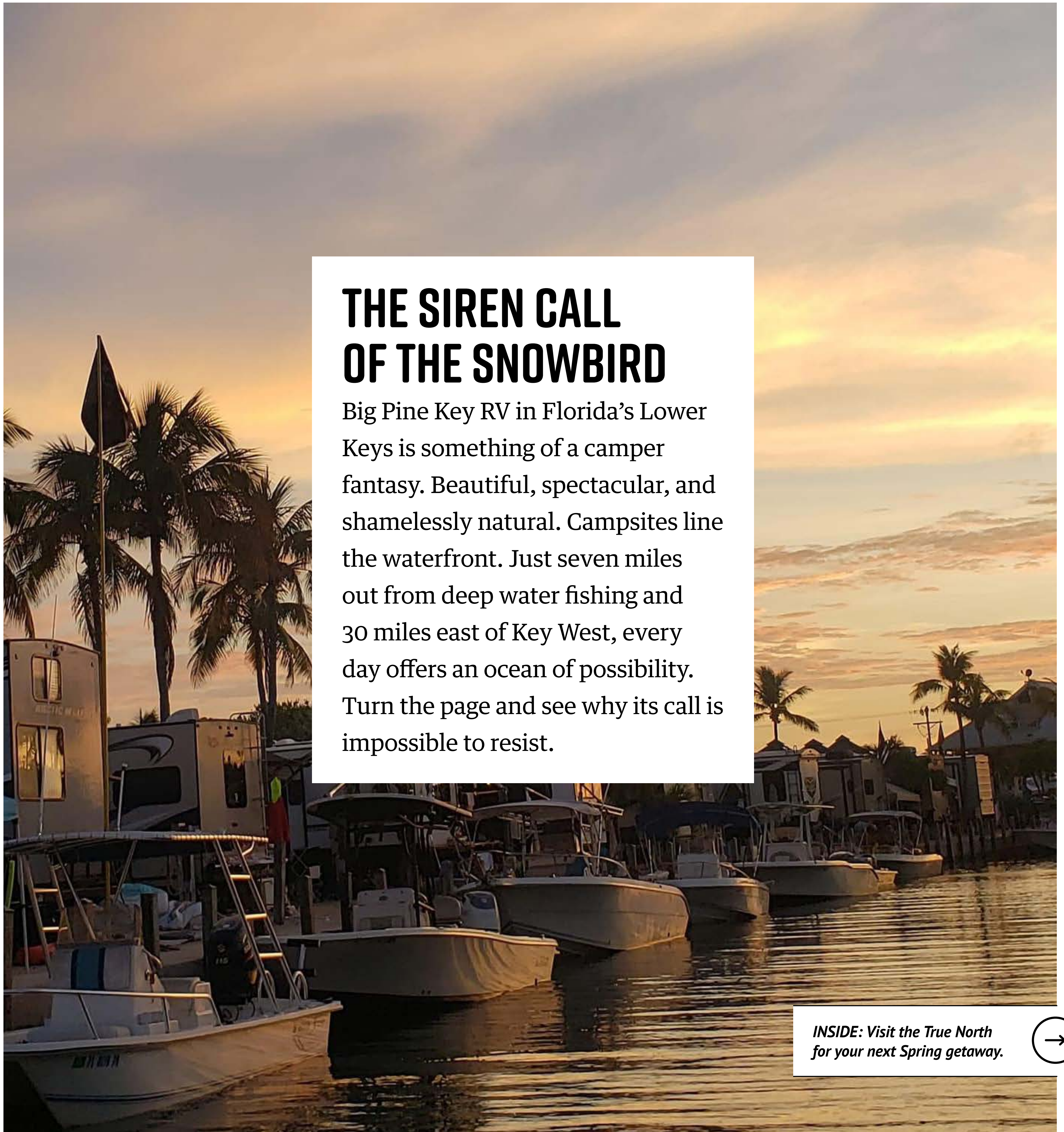

## THE SIREN CALL OF THE SNOWBIRD

Big Pine Key RV in Florida's Lower Keys is something of a camper fantasy. Beautiful, spectacular, and shamelessly natural. Campsites line the waterfront. Just seven miles out from deep water fishing and 30 miles east of Key West, every day offers an ocean of possibility. Turn the page and see why its call is impossible to resist.

*INSIDE: Visit the True North for your next Spring getaway.*

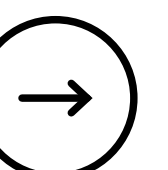



Travel Resorts of America

The Pursuit of Happiness.

# 21 NIGHTS COMPLIMENTARY\* CAMPING

## \$1000 VALUE

Call us today!

# 855.481.7411

CALL WITHIN 7 DAYS TO RECEIVE YOUR SURPRISE BONUS GIFT!



### MAKE GEORGIA YOUR NEXT STOP!

Fifty-five acres make up our beautiful North Shore Resort at Lake Oconee, GA. The campground was developed with a "railroad" theme and 23 railroad cars were brought in and used as offices, in recreational areas, as shops, and as overnight accommodations. Club cars, cabooses, and boxcars were used in the design scheme giving the resort a truly unique flavor for your next vacation stay.



### THE BEST CAMPING ON THE RIVER!

The perfect vacation destination located directly on the picturesque Mohican River in the heart of Ohio's Amish country. At Wally World you'll have the best camping sites on the river at a clean and family-oriented campground. With access to a full range of amenities and easy access to so many area attractions you'll want to come back again and again!



### RELIVE THE GETTYSBURG EXPERIENCE!

Located on the southern edge of the most famous Civil War battlefield, our amazing campground resort provides by far the best setting for the perfect family getaway. Whether you're soaking up American history or sun by our Olympic size swimming pool, you will discover unlimited opportunities for epic fun and relaxation at Gettysburg Battlefield Resort.



### FLORIDA FUN!

Whether you enjoy fan boat rides through the Florida wetlands, viewing world class wildlife, horseback riding, boating, fishing for largemouth bass, ziplining, Busch Gardens in nearby Tampa, Orlando attractions such as Disney and Universal Studios, attending a pro sporting event such as The Tampa Bay Buccaneers or just hanging at the resort pool, Thousand Palms will meet all your vacation needs.



### RELAX AT BASS LAKE!

Our activities and events are second to none, and take place year-round. Not to mention our two outdoor swimming pools; two clubhouses, one for families as well as one just for the adults; a miniature golf course; a restaurant and bar, a country store; nature trails, for both short walks and long hikes; laundry facilities and much more. As a gated and secure year-round resort, there's always a comfortable, safe and warm sense of community.



### NORTH CAROLINA AT ITS BEST!

Come experience one of North Carolina's most beautiful campground resorts, located just minutes from historic Pinehurst. Explore and enjoy everything Sycamore Lodge has to offer, from our historic main lodge and 200 acre forest to our private stocked lake, beach and swimming pool.



### LIFE'S AN ADVENTURE, ENJOY THE RIDE!

Located in the Salt Fork Lake Region. With over 850 pristine acres, this resort truly has something for everyone. Nestled in one of Ohio's most spectacular forests. You don't even need to leave the ranch for an adventure-packed vacation as amenities include: indoor heated pool, outdoor pool, horseback riding & trails, golf driving range, mini golf, paintball and so much more!

CALL 855.481.7411 TODAY OR VISIT US AT TRAVELRESORTS.COM

This offer is sponsored by Travel Resorts of America and includes up to 21 nights of complimentary camping and a 90-minute VIP tour (some restrictions apply). No purchase necessary. All camping certificates are redeemable at any of our private resorts and valid up to one year. These certificates entitle you up to 7 nights of complimentary camping during peak season, and two certificates of up to 7 nights each of complimentary camping during non-peak season. These certificates have no cash value and are non-transferrable. Offer not valid if you have toured one of our resorts within the last 24 months, if you are a current Travel Resorts of America or Coast to Coast member, or you keep your RV on a permanent site. Please call toll-free at 1-888-481-7411 to activate your certificate. Calls will be recorded for training and compliance.



# Playing the Right Key

**BIG PINE KEY RV IS MORE THAN AN ESCAPE. MORE THAN A RESORT. MORE THAN A MARINA. IT'S A SONG THAT BECKONS THE HEART OF EVERY WANDERER.**

## **I** MAGINATION STIRS THE WANDER IN US.

Mundane life might attempt to make us captive to its reality—where we're subject to subfreezing Winter temperatures or stuck in sluggish work cycles—but we can imagine a better way to chill.

Somewhere as far south as the road will take us. Somewhere with saltwater breezes and night skies full of stark-naked stars. Somewhere where you can catch your breath at last.

Somewhere like the Florida Keys.

Dropping like an anchor between the Atlantic and the Gulf of Mexico, your RV can take you there—plunging the weight of reality into waves of warm fantasy. Among the Keys, there's a different rhythm of life. The music of the ocean is everywhere. And that siren song has long made the archipelago a haven for renowned writers and reclining artists like Ernest Hemingway and Wallace Stevens. After all, when aquamarine water

surrounds you and a warm limitless sky covers you, how can you help but relax? That far away continental shore—with all its baggage—takes on a theatrical distance. It simply floats away. Like an ill-formed melody happily forgotten.

Past a crescendo of mile markers that drive you into the open sea, your windows come down. The air warms. Ideas of order blur, and you're ready. Ready at last to pull into the tranquil, tropical welcome of Big Pine Key RV.



## *A Sky Bigger Than Life*

The journey to the Florida Lower Keys is a gift in its own right. There is so little that compares. The Overseas Highway—aka U.S. Highway 1—casts a lean, two-lane line of road out into the Atlantic. Suddenly, with your RV hugging the narrow pavement and shallow jeweled water passing beneath you, the sky becomes bigger than life. Savannah Shafer, the community manager at Big Pine Key RV, laughs, almost songlike as she relates, “It reminds me of that old Dixie Chicks song ‘Wide Open Spaces.’ It has a major wow factor.”

The sights are so arresting that it’s common for visitors to pull their RV over along the way to simply take it in. Savannah understands completely, describing in a

stop-start way. “You’re gonna see a lot of people just—they can’t keep driving—they have to stop.”

The Keys can do that. They have a unique ability to captivate. While some destinations may draw you in with a boundless buffet of amenities, endless entertainments, and plastic pastimes, the Keys have a different agenda. Here, nature shines. History resides. The water calls. Nature does its own landscaping, with tangled mangroves, silver-haired buttonwoods, and fine coral limestone dust trails. Needless to say, if you can arrange it, arrive in daylight.

Hopping from key to key, you’ll remain on the Overseas Highway for an hour and 45 minutes (not including stops, of course). Even driving out in the water, intriguing relics of history can be seen. Just prior to reaching Big Pine Key, on your driver’s side, you can look out the window into the waves and see the 1912, old-truss Bahia Honda Railroad Bridge, with its ruins lying in the water like a fallen titan. Just a little further across the sea, two keys away, is Big Pine Key RV, calling you in.

## *A Rare Resort of Wild Beauty*

Immediately on crossing onto Big Pine Key, you’ll spy the RVs parked along the resort’s waterfront. The first left turn lands you directly in front of an unmistakable two-story building with a bridge that goes over to a second-story swimming pool. Built in 1959, it’s steeped in local history. Purchased by Cove Communities a few years back, it’s attentively cared for.

*Take a look at the Bahia Honda Railroad Bridge.*





Complete with a boat canal, the resort bustles with fishermen and swimmers. As new Winter guests arrive and step out of their vehicles, Savannah says that it's impossible not to notice how relieved they are.

“For those who come from the North down here, when they walk out of their rig, it is so funny. It's almost consistently like a groan! You know that they've just come from whatever negative

temperatures, and they've finally arrived.” Savannah knows what's next too. “In no time, the pool is full of people in bikinis. They are here to get their tan. Here to get their lobster.”

They've come to the right place. Entering the front office and store, the whole vibe trills with the relaxed swagger of beach rustics. The store is filled with fishing tackle and mail and boat fuel. Desk clerks check folks in behind a

standing desk. And Savannah notes that the staff “can usually tell the way that someone walks in the room what they're here for.” Whatever you're there for, an escort will go and assist you getting into your site, answering any questions you may have, and making sure your utilities work. The RV park has 173 sites, many with boat slips, including 19 premium spots.

*Book your stay at Big Pine Key RV.*



Very quickly, you'll see that the resort in many ways embodies the Keys—in its care for nature, respect for history, and passion for the water. The sites are simple



and wide open. And those who stay absolutely love it. There are remote workers and homeschooling families staying for the season. And of course, there are the fishermen, snorkelers, divers, and kayakers. Many come mid-December through March when the ocean breeze graciously reduces humidity and brushes away noseems (biting midges). But nature, in its more pleasant forms, is also a big part of the identity of the RV park.

Big Pine Key RV is uniquely nestled into a wildlife preserve, the National Key Deer Refuge. It's quiet and peaceful with few neighbors. Not including, of course, the key deer. Savannah points out, "They walk right in. Even right up to you." And because of that, guests are taught how to behave around the local wildlife.

## “Welcome to what it’s like! Everybody says that!”

Savannah explains, “The history of this park has been this dance with officials, wildlife, and even natural disasters. This place has been sensitive to that and been a help. It makes our park unique.”

Part of that sensitivity is that around half of the park is zoned as protected land. Which means that half of the park offers dry camping sites. Savannah says, “You can tent camp. Solar camping is huge. I feel like we are one of the only private camping locations—

that I’m aware of—that really wants to celebrate the fact that we can take in large rigs that are solar and give them a tent camping price.”

Savannah adds with a smile, “That’s actually what drew me personally! My husband and I and our six kids, we lived on solar power for three months here. And we were not the only ones—by far.” Her family stayed in a totally redone 1986 Fleetwood Prowler. They stayed three months, but they didn’t plan to originally.

“Rustic more than any other part of our park is known for ‘Let’s add on another week ... Let’s add on another week.’ And I remember when I was here as a guest saying that. They were like, ‘Welcome to what it’s like! Everybody says that!’ ” Her voice slows and grows pensive, “You get here, and you just can’t leave.

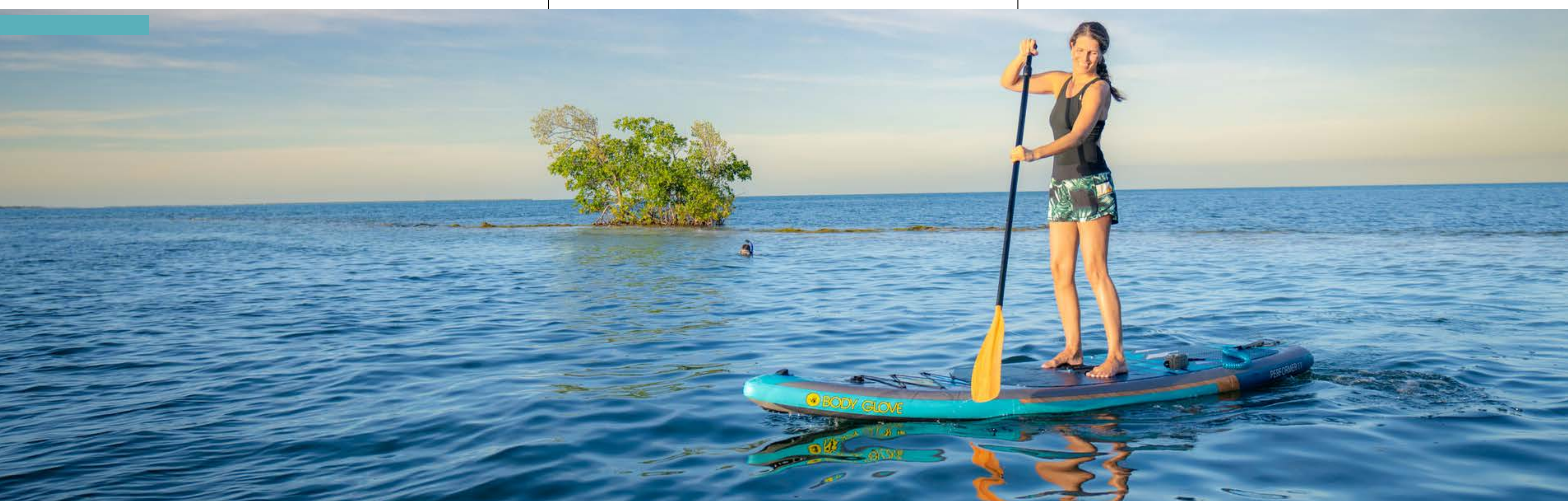



Because you see every star. It's so quiet. It's a special place."

And there's more to discover outside the RV park—no matter which direction you head, land or sea.

### *Hidden Coves and Historic Bike Trails*

Somehow, for all its bulk of landmass, the continental part of our country can often feel so crowded. How ironic that Florida's Lower Keys do not. Lapped by expansive ocean, the waves issue a daily invitation. Deep-sea fishermen, divers wielding spears, and web-footed swimmers with their snorkels—all covered in sun—radiate out each day into the blue-green surf that calls them. And they return with fresh catches, impaled trophies, and dripping smiles. The seasoned sea dog and the novice alike are welcome here. Charters abound to initiate the curious guest. And they're

not for fishing alone. There are charters to kayak among mangroves, sandbar charters, and adventure charters to explore every cranny of the island.

But every camper knows that the best adventures involve an element of discovery.

Few places play hide-and-seek like Big Pine Key. Sure, there are the go-to, easy-to-find, even-easier-to-enjoy spots—starting with Winn-Dixie at Big Pine Key Plaza. Nearby, there's the [Big Pine](#)

[Key Flea Market](#) with its eatery and local fish fry. Restaurants are almost all brought to you by the letter K, from the [Florida Keys Cafe](#) (a local favorite) and [Boondocks](#) (a tiki bar and draft house with miniature golf) to [Kiki's Sandbar](#) (a waterfront bar & grille). Cyclists can park their bikes at Winn-Dixie and catch the bus for Key West to get a taste of Caribbean culture, an hour-and-a-half ride away. But if you really like to spin wheels, you can even island-hop by bike on the spectacular and historic [Florida Keys](#)



# Warm up... Outdoors

with our **portable campfires.**



58035  
Big Red Campfire

Perfect for campsites with in-ground fire restrictions!



58031  
Little Red Campfire



Buy now at: [www.CamcoOutdoors.com](http://www.CamcoOutdoors.com) 

**Overseas Heritage Trail.** (It takes about three hours to bike to Key West from Big Pine Key.)

Still, no need to exert yourself to find adventure. Local treasures might be just under your nose—but hidden. Savannah shares two of her favorites.

“We have the Blue Hole, which is an old quarry where the alligators have taken residence. They stay in there.” Even so, Savannah, a mother of six, laughs and says, “Hold onto your kids. I remember thinking, ‘There’s no barrier!’” Long ago, the shady quarry used to be a swimming hole—but not anymore. Now, the draw is spotting gators (there’s a nice observation deck) and hiking the trails around this cool reptilian dive.

Then there’s the **No Name Pub.**

Savannah says, “You gotta go at least once.” Describing how to get there quickly turns into a stream-of-consciousness narrative that’s almost impossible to follow. “It’s one of those restaurants: Have fun trying to find it. It literally is a hidden restaurant. If someone were



to say, ‘How do I get there?’ I’d say, ‘Umm ... You’d have to go right at the first light, go all the way down that road, then you have to turn left, go right, go left, go around that, go around that, before the bridge, to the left—you may miss it! You’ll be surprised how big it is inside.’ It’s one of those places.”

Once you get there though,

the instructions get simpler: Order the pizza, says the mother of six. After all, exploration is hungry work.

## *The Irresistible Call to Return*

There are special places in the world that leave their imprint on us. The kind of feeling that doesn’t wash away over time, but rather deepens and almost becomes part of who we are. As RVers, we know this better than anyone else. Which is why the draw to Big Pine Key is not singular. It’s cyclical, like the chorus of a familiar



## Light Your RV with Earth-Friendly LEDs

**12v Bee Green LED lights and bulbs include:**

- Extremely Low Profile Ceiling Lights
- Reading Lights with USB Charge Ports
- New Tech with Amazingly Even Light Patterns
- New 3-in-1 Color Temp Pancake Light with Dimmer
- Dual Color Fixtures and Replacement LED Bulb
- Variety of Fixture and LED Color Options

**Save Power. Bee Green.**  
Learn more at [www.beegreenled.com](http://www.beegreenled.com)  
941-378-9727



Sold by SalVinCo LLC

song. Like remembered poetry that almost spills from our lips by pure reflex.

Cooking breakfast on any given morning at the RV park, you see the sun rise. Doing dishes, from your window, you watch people throwing their nets into the sea. You hear the rumbling motors of boats pressing out into the morning tide and expanse of reef, the sound of swim fins slapping against the ground. The lines between campground and marina are happily blurred in this haven where seeing a Class A tow a boat is mere common fare. You don't forget places like this.

Savannah knows that in a deep way. She fell in love as a faithful guest long before she ever worked here. And, one of three consecutive women to help run the resort, she takes pride in continuing to nurture the culture that drew her in. A culture that felt like more than a campground. She confesses that, even as a manager now, walking back toward her old family campsite still fills her with this sense of longing. A drawing back. And she's not alone. "Those who have heard of the place love it. And they continue to come back. I'm

## WHEN IT NEEDS TO LAST A LIFETIME. SPRAY IT ON.

**FlexArmor** is the only professionally sprayed-on RV Roof with a lifetime no-leak guarantee.



Can't Do *THIS* With A Roll-On Product

**Request A FREE Sample**

Visit [RVRoof.com](http://RVRoof.com)

[RVROOF.COM](http://RVROOF.COM)



The ORIGINAL Sprayed RV Roof



**FREE ESTIMATES & ROOF INSPECTIONS**

**(844) 353-9276**

talking—grandma brought us; and now my parents brought us; and I'm an adult now, and I'm bringing our kids here. There is no other place to go in their minds. This place transcends generations."

So, fellow wanderer:

beware, lest you hear the keener sounds, the recursive notes of that salt-sprayed RV park at Big Pine Key. Because no matter what reality you go back to, an irresistible call from the island will forever beckon: Return.



# A Clever Turnaround

Look at you—springing up to see the Great White North thaw out and uncover its natural treasures.



CANADA

CAPILANO RIVER RV PARK

WEST VANCOUVER, BC

CAPILANORIVERRV.PARK.COM

The snowbird southbound migration—from Canada to Miami—is much documented. (Exhibit A: Um, this issue.) But come Spring, when the Great White North is shaking the snow off its shaggy mane, the vast Canadian landscape resurrects in brilliant greens and explosions of life. And everyone perfecting their tans down south will miss it.

But not you.

Canada has border cities by the dozen, but our top pick is Vancouver. Less than an hour north

of the Washington State border up Interstate 5, you'll find the Capilano RV Park. With full hookups, lots of amenities, and unparalleled proximity to Vancouver itself, it's the perfect home base to explore British Columbia—be that the Capilano Suspension Bridge (a must see), whale-watching (yes, please), or the glories of the Wild Pacific Trail (a five-hour day trip away). As the weather warms, you'll also find yourself in striking distance (526 miles) of the breathtaking beauties

of Banff—a bucket list experience.



*Yes, Canada is our next-of-kin neighbor. Yes, you can RV across the border. And yes, you still need a passport. Check here to get a good checklist from Progressive of everything you should think about before you make your big move north.*

# RVX

**INSIDE:** Wanna see a sea cow? (Of course you do.) Read our manateaser.



CAMPING, ADVENTURE, AND THE RV EXPERIENCE

## WIN THE WINTER CAMPING ARMS RACE

There's a popular saying in sports: Respect your opponent. Well, for us all-weather campers, that's Old Man Winter. He's mean. Has ice-water in his veins (and wants to put ice-water in our plumbing). But you don't have to whip him—you can out-equip him. Turn the page and get started with our winter camping favorites.





# CLUTCH GEAR

# FOR COLD WEATHER

## ALL-WEATHER CAMPING? DON'T GET CAUGHT IN THE COLD WITHOUT THESE **14** ESSENTIALS

BY MARK SETTLE

Ages ago, when I was in the Army, we all used to play a game when the temp dropped below freezing: Who could wait the longest to put on your “snivel gear?” If you want to know who won, that’s easy to remember—no one. It was flat-out misery. Cold weather ain’t no joke, and you don’t have to

fight it. In fact, it’s far better—and smarter—to out-equip it! (Snivel gear and all.)

There are lots of good reasons to tackle all-weather camping. Winter ushers in some of nature’s most beautiful scenes. Supremely still landscapes. Bright dawns and crisp mornings. Perfect

solitude. Coffee takes on new meaning. But if you wanna truly enjoy it—be that one weekend or a whole season—you and your RV will need some clutch gear for the cold weather.

Sure, there are more you could add to this list, but these little babies are our favorites.

# KEEPING THE CABIN COZY

*Extra power, heaters, and heat keepers.*



## **Honda EU2200i 2200i-Watt Super Quiet Generator**

**BACKUP IS NON-NEGOTIABLE IN THE COLD, DARK NORTH.**

*Not having backup power is not even an option in cold-weather camping. So why not have one of the best? Honda's EU2200i is not just powerful. It's not just easy to use. It's also quiet. Which is sweet, because you need power, not noise.*

► [Buy at Amazon.com](https://www.amazon.com)

## **Camco Olympian Wave-8 Catalytic Heater**

**BECAUSE SOMETIMES YOU WANT HEAT—RIGHT HERE.**

*Even in the coziest camper (or home for that matter), heat is rarely evenly distributed. But come wintertime, we have a very specific idea where the warmest spot should be: right where we are. Camco's catalytic heater is slim, toasty, and safe indoors—but (as always) pay close attention to those ventilation instructions.*

► [Buy at Amazon.com](https://www.amazon.com)



## **Airskirt RV Skirt Kit**

**WARM THAT WINTER UNDERBELLY.**

*In our eyes, it's pretty simple: If you're committed enough to camp in cold weather, you're gonna see the value of Airskirts. With custom kits for any kind of RV, Airskirts makes protecting your undercarriage (and things like your water pipes) simple, reliable, and easy. Once you park, you can be set up in under 30 minutes.*

► [Buy at Airskirts.com](https://www.airskirts.com)





## **Sikadeer** Skylight Insulator

### SLAM THOSE HOT-AIR ESCAPE ROUTES SHUT.

*Have you noticed that RVs have holes in random places? (You have? Good. Us too.) We know they're necessary, but man! There sure are a lot of places for hot air to escape. Covering the big ones, like your skylight, can make a huge difference.*

► [Buy at Amazon.com](#)

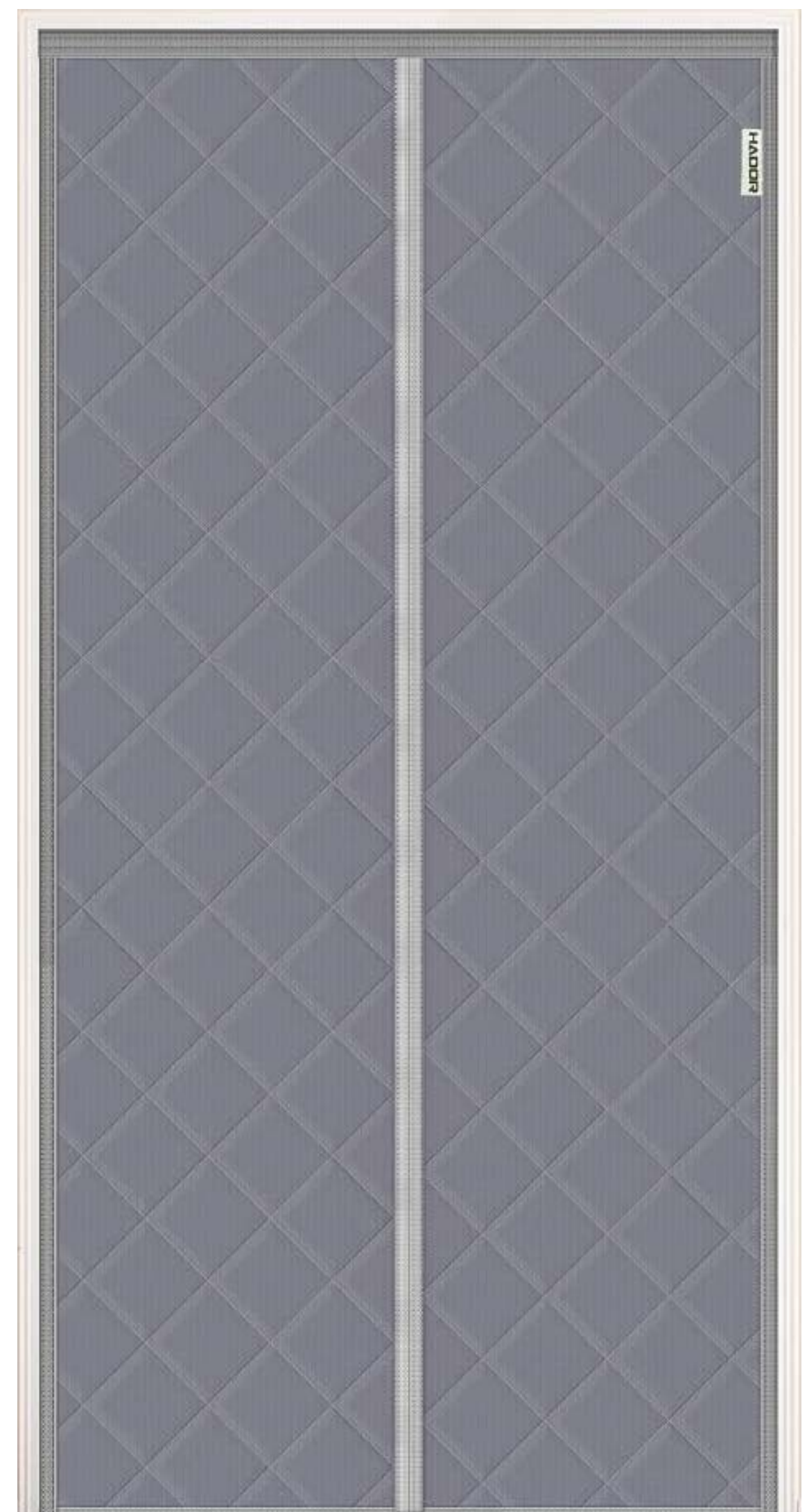

## **HADOR** Magnetic Thermal Insulated Door

### SET THE CABIN UP LIKE A HEAT CHAMBER.

*There are all sorts of good uses for the HADOR magnetic thermal insulated door, so more than one purchase may be in order. Whether you use it to insulate your cabin door or your bedroom entrance way (or both), you'll love it. But for the exterior door, it actually insulates. So you save heat, even when the door is closed.*

► [Buy at Amazon.com](#)



## **Valterra** Heated Fresh Water Hose

### A HOSE THAT GOES GEORGE CLOONEY ON MR. FREEZE.

*Eliminating worry is a big thing we're going for here. And worrying about our water in an isolated RV in the Winter is something we'd rather not do. Valterra's heated fresh water hose alleviates those fears. The heat source self-regulates temperature. And its cuffs on each end are freeze protected.*

► [Buy at Amazon.com](#)

# BRAVING THE ELEMENTS

*Gear to get out and enjoy that Winter cool.*



## Helle Nord Knife

### CARRY A NO-NONSENSE KNIFE.

*Wanna be clear here: Helle has the sharpest knives I've ever handled. They're deadly sharp. And dangerous. Which is just the kind you need in these elements—the kind that gets the work done fast. The Nord (with its curly birch handle, full-tang blade, and leather sheath) is just the no-nonsense knife you'd expect from Norway.*

► [Buy at Helle.com](https://www.helle.com)



## Omnia Stovetop Oven

### THE PORTABLE WAY TO HEAT, BAKE, AND COOK.

*If carrying that Norwegian knife hasn't made you feel like a Viking yet, maybe cooking outdoors with a Swedish stovetop oven will. With the Omnia, if you have a heat source (other than induction), you have an oven. Inside or outside, you can cook veggies, hash browns, fish, bread, you name it.*

► [Buy at OmniaSweden.com](https://www.omniasweden.com)

## Stanley Classic Legendary Bottle (2QT)

### WE DON'T NEED 45 HOURS OF HEAT. BUT IT'S AWESOME.

*Being able to take something warm with you outside—be that coffee or soup—can be a huge game changer on your I-feel-like-being-out-here scale. Stanley's Classic Legendary Bottle keeps your precious liquids as hot as they were in the galley. And it has other endearing features, like a handle that keeps it from rolling everywhere.*

► [Buy at Amazon.com](https://www.amazon.com)

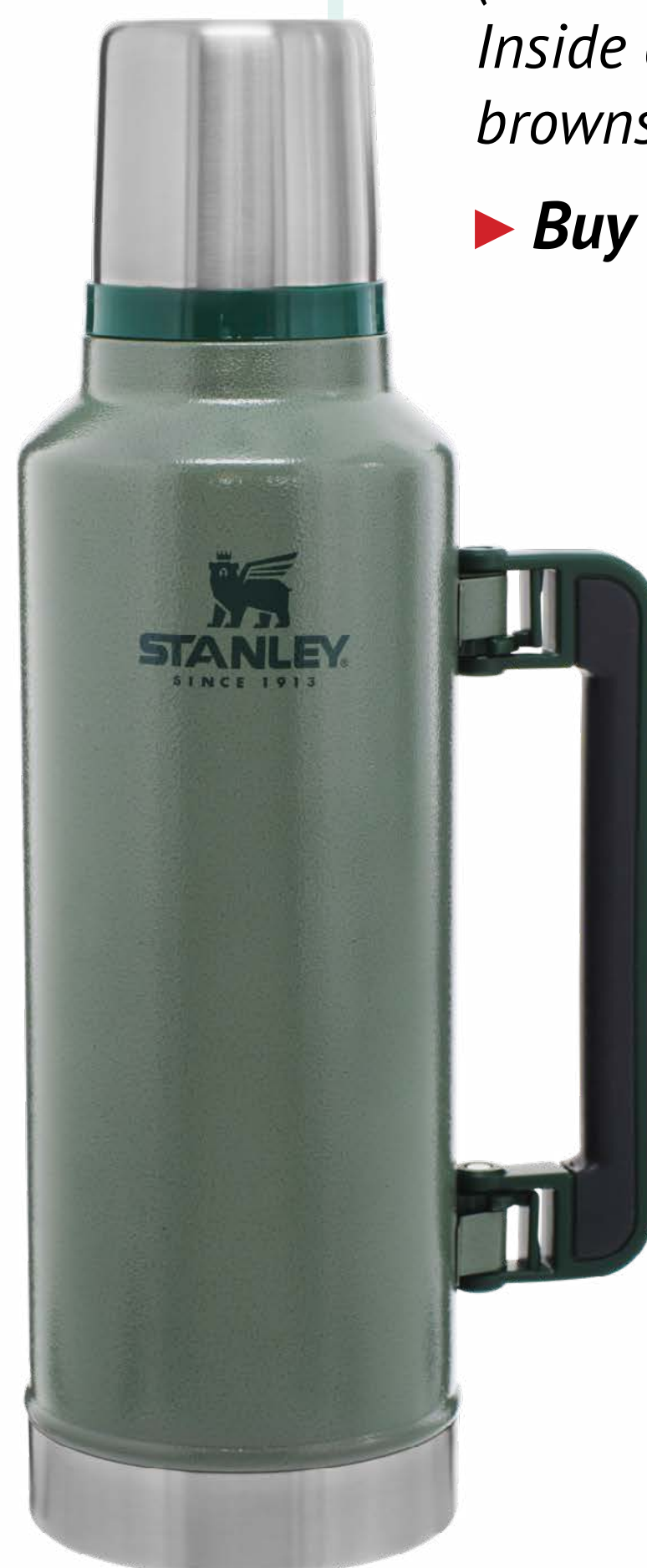



**ORORO**  
Men's Soft Shell  
Heated Jacket

**DRESS FOR THE COLD WITH WARMTH ON-DEMAND.**

*This is our kind of technology! Jackets are supposed to keep you warm, right? If that's their job, then ORORO does it best. This heated jacket gives you between three to ten hours of heat, depending on the heat setting you designate. Which should be ample time for us to do what we gotta do before we return to our toasty cabin.*

► **Buy at [OroroWear.com](http://OroroWear.com)**



**Gobi Heat**  
Camping Chair

**OTHER CHAIRS MAY BE COOLER ... BUT THAT'S THE POINT.**

*Not gonna belabor this one—N8 says it all [right here](#). You can even watch him review it on YouTube.*

► **Buy at [GobiHeat.com](http://GobiHeat.com)**

**A NEW PRODUCT BY**  
**Magne Shade®**

**Magne Screen**  
by Hunckler Fabrication LLC  
PATENT PENDING

Magne Screen™ is the exclusive magnetic awning drop shade for automatic awnings.

**Magne Shade®**  
by Hunckler Fabrication LLC

**MagneShade.com**  
**336-753-0905**

# CLEARING YOUR EXIT ROUTE

All-weather tools to ensure a safe start home.



## JoyTutus 47.7" Extendable Snow Brush and Ice Scraper

**SOME EXTRA REACH TO BRUSH WINTER ASIDE.**

Brushing snow and scraping ice off our giant RV are activities we'd like done as quickly as possible. So having a two-in-one tool with some real reach (almost four-foot long) is a lifesaver. The JoyTutus's 270° pivoting snow brush even enhances your ability to hit odd spots (like the roof and slideouts).

► [Buy at JoyTutus.com](http://JoyTutus.com)



## Rhino USA Recovery Traction Boards

**SAY "NEVER" TO GETTING STUCK.**

You may have read that in the snow you should take kitty litter in case you get stuck. That may work, but can we agree that's not the best option? Get the right instrument: recovery traction boards. They'll not only save your backside if you're stuck in the snow, they'll be just as useful for self-recovery in mud and sand any season of the year.

► [Buy at RhinoUSA.com](http://RhinoUSA.com)

## AstroAI 39" Folding Snow Shovel

**A COMPACT NECESSITY.**

Think about needing a snow shovel and not having one. Now imagine that when you need it is when you want to go home most. Don't live that moment. AstroAI makes a collapsible folding snow shovel that you can easily stow.

► [Buy at Amazon.com](http://Amazon.com)



PREFER A MORE  
TROPICAL WINTER?  
WE GOT YOU.

**FLOCK TO OUR FEATURE**

# Pulling into a Mermaid's Cove

**WE REALLY DON'T KNOW** the exact number of miles you have to travel before manatees start looking like mermaids (if you know, please tell), but it can be a long RV drive to Miami (so we're curious). In all seriousness, being able to encounter one of these gentle, friendly, and comically large (and whiskered) creatures is one of the childlike delights that awaits snowbirds in South Florida. Whether you encounter them at the surface or under the sea, don't be surprised that these sea cows look more like Uga than Ariel.

## WHY GO

Nature is at its very best when it feels personal. And few wildlife experiences are as personal—and magical—as meeting a manatee. Just don't fall in love. (King Triton says that is strictly forbidden.)

## WHERE TO GO

Crystal River is one of the rare places in the world where you can have an in-water experience with manatees. Tours with River Ventures are easy to book, and the Crystal Isles RV Resort is just 20 minutes away.

## WHEN TO GO

November to April



## I Heart Tip

Resist the temptation to touch! (Or kiss, you shameless romantic.) Manatees are naturally friendly and curious, but they're also protected by federal law. So mind your best manatee manners.



## MERMAID SECRETS

Get some expert advice from our friends at The Boat Notes.

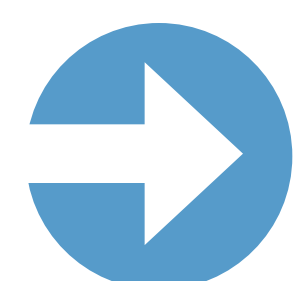



# Get 5G on the Road. Fast. Reliable. Secure.

Discover how AT&T enables our fast 5G speeds for customer to download, stream, and share when you're on the road.

