

**TOUR** THE WINDY CITY / **DISCOVER** STARVED ROCK STATE PARK / **SHOP** TOP WINTER JACKETS

# I RVing

## 25 *TOP RV DESTINATIONS FOR '25*

## PLAN YOUR ULTIMATE RV BUCKET LIST

*What's Realistic & What Isn't?  
It Might Surprise You!*

## TOP TOY HAULERS

*We Review the New Rigs  
for You and Your Toys*

## + *Go Inside*

Slow Cookers vs.  
Pressure Cookers,  
Which Is Best?



**WINTER ISSUE 2025**

@IHEARTRVING f    
IHEARTRVING.COM

# Winter Special

VOLUME 4 / ISSUE 6 / WINTER 2025

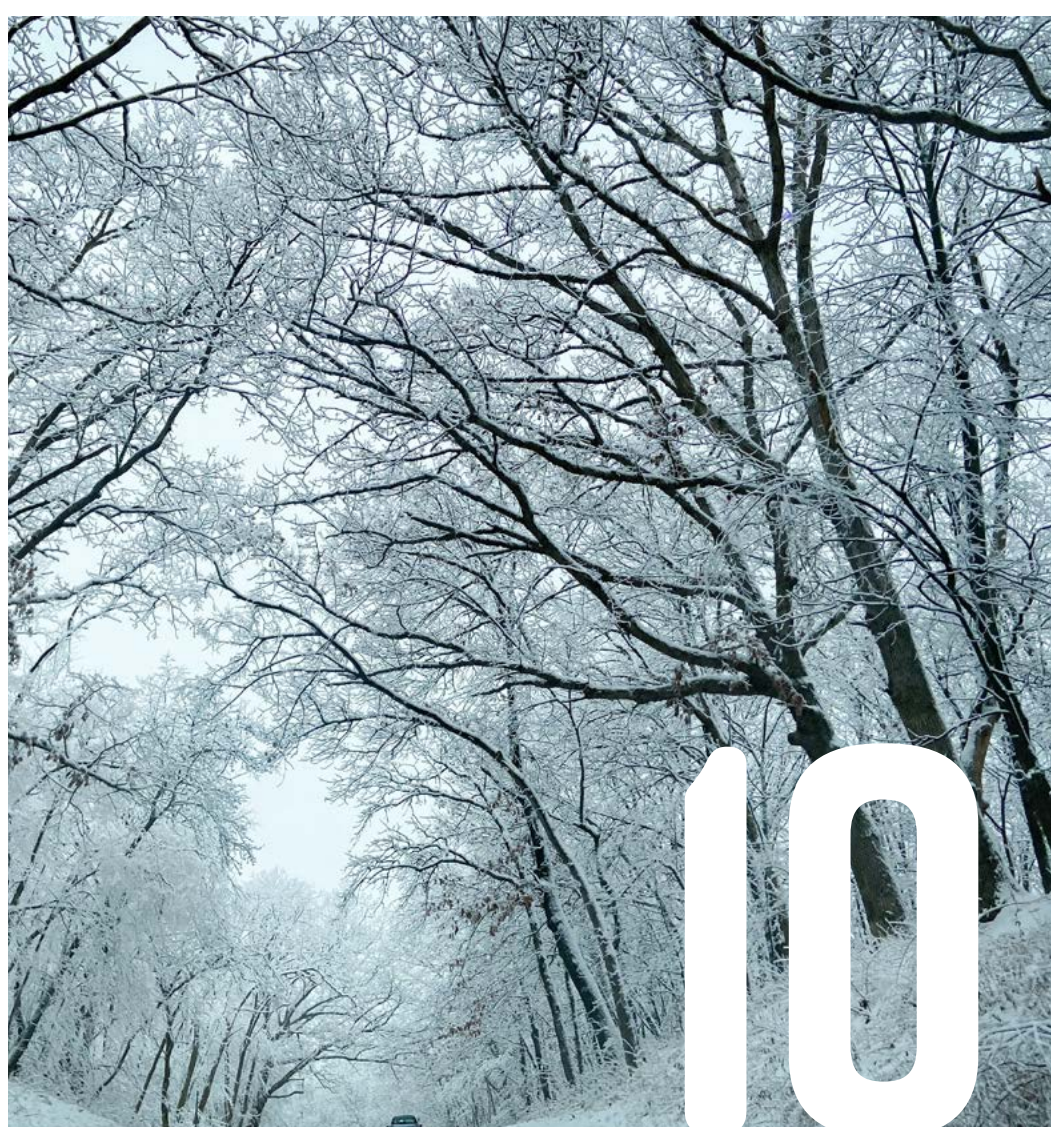

## 05 Mirror Check

*A Brief Look at the RV News and Community*

Catch up on the RV news, events, and people, and try out a new cozy winter morning playlist.

JUMP TO YOUR FAVORITE SECTION—JUST CLICK!

## 08 American Vista

*Vantage Points of American Beauty*

Chicago provides a perfect mix of urban exploration, waterfront relaxation, and cultural opportunities.



## 19 Road Abode

*Improving Life on the Go*

Kick off 2025 by exploring innovative RV cooking gadgets that can transform the way you prepare your favorite pasta dishes.

## 33 Top Level

*RV Tech and Tradecraft*

First look at the best Toy Haulers for 2025, from budget-friendly trailers to luxurious fifth wheels.



## 41 Edge of the Map

*From the Highway to the Campground*

Rediscover America with our comprehensive list of the Top 25 Destinations for 2025.

## 51 RVX

*Camping, Adventure, and the RV Experience*

Elevate your cold weather adventure with these exciting smart buys.



## 62 Fireside

*Camping, Adventure, and the RV Experience*

Revisit the all-time best road games.

# I♥RVing

## I HEART RVING

managing editor | **Sue Mosebar**  
design director | **Brian Harvat**

sales & partnerships director | **Laurie Zak**  
(laurie@iheartrving.com)

Please contact us to advertise with I Heart RVing

video & social producer | **Nate Kennedy**  
social promoter | **Craig Mitchell**  
email manager | **Jessica Jiron**  
digital marketing specialist | **Larry Norris**  
developers | **Ralph Aroljo, Spencer Olive**  
intern | **Lilly Petsolt**

I HEART RVING LLC  
cofounder | **David Petsolt**  
cofounder | **Adam Acosta**

**THANK YOU FOR JOINING US AT THE  
I HEART RVING GLOBAL CAMPGROUND.**

**PACK IT IN, PACK IT OUT  
EXTINGUISH ALL FIRES**

**SORRY FOR WHAT I SAID WHEN I  
WAS TRYING TO PARK THE RV**

## FINE PRINT/DISCLAIMERS

Copyright © 2025 by I Heart RVing, LLC

Published by I Heart RVing, LLC. I Heart RVing Magazine was founded in 2021 by a crazy bunch of dreamers, story makers, and idea tree shakers who just want to watch the world read.

I Heart RVing makes every effort to provide information that is informative and practical. The publisher, editor, and writers are not responsible for any adverse outcomes or consequences resulting from the use of suggestions or products that appear in this magazine. The acceptance of advertising in this publication does not constitute or imply endorsement by I Heart RVing, LLC (including parent companies, contributors, affiliates or partners) of any advertised product or service. I Heart RVing accepts no responsibility for claims made in advertisements in this publication.

For all subscription updates and inquiries, go to IHeartRVing.com and submit a Contact form with your details. To subscribe to the magazine, visit IHeartRVing.com/subscribe. To submit a story idea, please contact editorial@IHeartRVing.com.

## Dream Big!

Dear Fellow RVers,

If you talk with many gardeners, this is the time of year they're most excited about. They're busy thumbing through seed catalogs, deciding on what they're going to grow, what to change, and how to make this upcoming season even more bountiful. It's all about embracing the potential of what's to come.

In many ways, RVers aren't so different. While some are taking advantage of all the great opportunities winter camping brings (good on you!) or embracing the joys of year-round travel—rain, snow, or shine—others have tucked their rigs away for a long winter's nap. If you fall into the latter group, you might be feeling a twinge of cabin fever right about now. But I invite you to think like gardeners and use this time to dream.

Consider this season to be the perfect opportunity to envision your travels to come. A time to create a list of adventures, start planning (and making reservations for) the first road trip, and perhaps vowing to spend more time RVing this year than ever before!

It may even be an ideal time to consider upgrading your RV or making your first purchase. How about one that's made for bringing



all your toys and gear with you to create your own adventures?

Indeed, this issue is all about dreaming big. We've packed it with inspiration—from the top 25 destinations to visit in 2025 to featured locations and campgrounds. We even dive into how to build the ultimate RV bucket list for you to make this the most adventurous year yet.

Of course, it's vital to stay energized on the road, so we've got plenty of ideas to fuel your adventures. And for those who are braving the cold (or itching to hit the road as soon as spring arrives), we've got you covered with tips on staying warm—from hearty, belly-warming meals to the best winter coats to pack for your trips.

Here's to dreaming big and making even bigger adventures happen—whether you're already on the road, packing up the RV, or cozy at home, gearing up for the next season!

Cheers!

*Sue Mosebar*  
**Sue Mosebar**



# SPORTTREK

TOURING EDITION

Designed for Campers  
by Campers!



## Cherishing Every Journey Together

At Venture RV, we believe in the magic of family moments. Our mission is to connect loved ones with the beauty of the outdoors, creating cherished memories along the way. Our dedication to quality and craftsmanship means we take care of the details, so you can simply enjoy time together.

Discover our SportTrek Touring Edition Luxury Fifth Wheels and Travel Trailers.



(888) 988-8440



Learn more about our lineup  
[venture-rv.com](http://venture-rv.com)

IN THE NEWS

## A Bright Future for RVing



### ECONOMIC IMPACT + LEGISLATIVE SUPPORT FOR OUTDOOR REC = A POSITIVE OUTLOOK FOR THE RV INDUSTRY

We're not the only ones who are seeing the positive impacts of RVing. It's also a driver of the U.S. economy, contributing real dollars. We're talking over \$140 billion every year. That translates to nearly 680,000 jobs nationwide. The growth reflects the growing public interest in outdoor recreation and people embracing the way of life only afforded by RVing. What better way to customize the way you travel than by hitting the road in your RV?

Complimenting the recent boom, new legislation is helping further boost outdoor recreation opportunities with the recent passage of the

EXPLORE Act (Expanding Public Lands Outdoor Recreation Experience) as of January 4, 2025. This bipartisan legislation aims to enhance access to outdoor recreation across the nation, benefiting outdoor enthusiasts, including RVers, as it improves infrastructure and expands access to public lands.

While the outlook looks sunny, potential challenges do remain. The hope is, of course, to improve access. However, implementation will require effective coordination among federal agencies and adequate funding to ensure it reaches communities. Other

economic factors (e.g., tariffs, interest rates, and inflation) could also cool retailer and consumer spending alike. That said, the industry is poised for growth, as long as it navigates potential economic and policy headwinds. Let's continue to pull for this positive trajectory!



The number of Americans who planned to travel by RV this past holiday season:

# 21M

## RVs to the Rescue

Hurricane Helene wreaked havoc in the Carolinas, Georgia, and Tennessee last September, leaving too many wondering if they'd have a place to call home for Christmas. Enter Emergency RV, a 100% volunteer-based nonprofit that donated 77 campers—completely free with clean titles—to those impacted by this devastating event. That's the power of the RV community's commitment to supporting people in times of need. Learn more at [EmergencyRV.org](https://EmergencyRV.org).



## Winter RV Events

### Tulsa Boat, Sports & Travel Show

Dates: January 27 - February 2, 2025

Location: Sagenet Center at Expo Square, Tulsa, OK

[tulsaboatshow.com](https://tulsaboatshow.com)

### Iowa Original RV Show

Dates: January 30 - February 2, 2025

Location: William C. Knapp Varied Industries Building, Des Moines, IA

[iarvshow.com](https://iarvshow.com)

### 59th Annual Detroit RV & Camping Show,

Dates: January 29 - February 2, 2025

Location: Suburban Collection Showplace, Novi, MI

## Complete list of RV Events

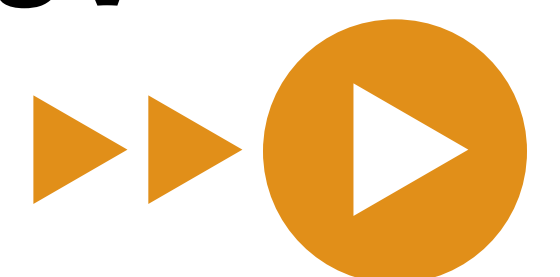



## COZY WINTER MORNING PLAYLIST

THERE'S SOMETHING SPECIAL ABOUT SLOWING DOWN ON A COZY WINTER MORNING. PERHAPS CRADLING A WARMING BEVERAGE AS YOU SOAK UP THE SURROUNDING WINTER LANDSCAPE, ENJOY A NEW BOOK, OR WATCH THE MILES GO BY. ALL YOU NEED NOW IS A SOUNDTRACK. THIS SOFT, SMOOTH PLAYLIST DELIVERS JUST THE RIGHT VIBE FOR A COZY WINTER MORNING.

PLAY ON SPOTIFY



### @letsturnitupworld

**Why We Heart It** – Love this couple with great adventures, great humor, and extensive youtube content. 😊



### @rv\_travel\_adventures

**Why We Heart It** – This part-time RV couple has the scoop on everything RV... accessories, tips, tricks and more! Plus, great insight on traveling with pets. 😊

# American

VANTAGE POINTS OF AMERICAN BEAUTY

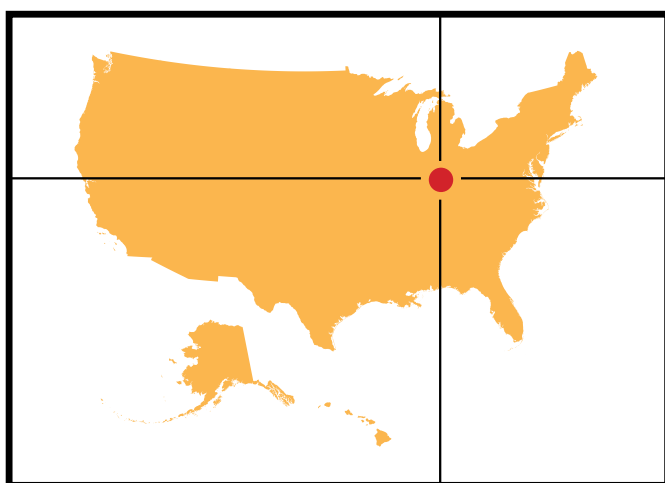

▶ 48°30' N, 92°53' W

▶ ILLINOIS

▶ [WWW.ENJOYILLINOIS.COM](http://WWW.ENJOYILLINOIS.COM)

# Vista



**JUXTAPOSED AGAINST THE SHORES OF LAKE MICHIGAN, FEW SKYLINES ARE AS ICONIC AS CHICAGO'S.** RVers can make the most of the city by claiming a spot at a nearby campground before making their way to the city's heart. Chicago provides a perfect mix of urban exploration, waterfront relaxation, and cultural opportunities.

Because it's a jungle out there.

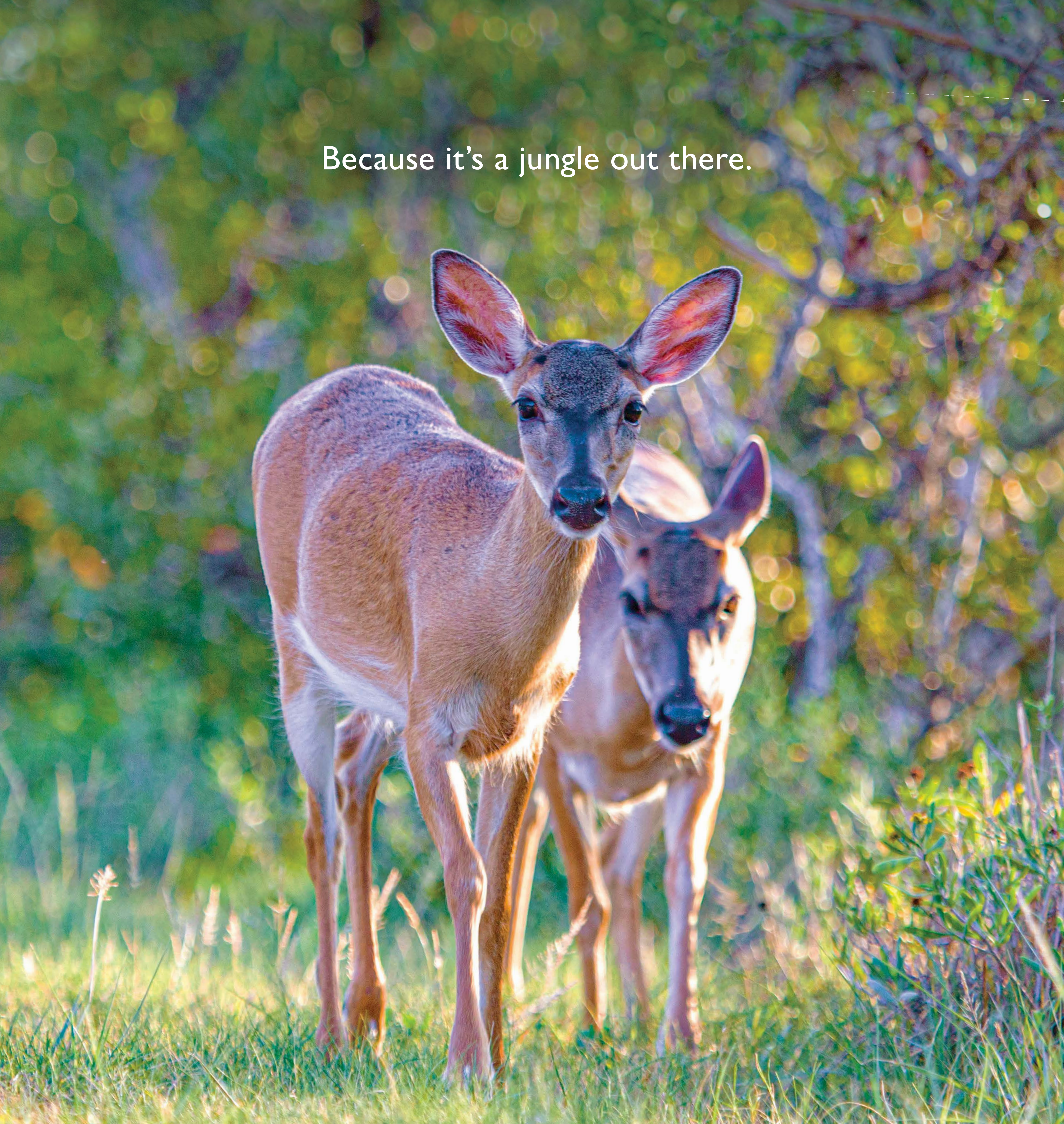

Florida's Lower Keys are home to two wildlife refuges, epic ocean views, miles of unspoiled wilderness and an array of outdoor accommodations ranging from rustic campsites to lavish RV parks. From Big Pine to Stock Island, you'll never run out of extraordinary places to step off the treadmill and watch the world go by.

[fla-keys.com/lowerkeys](http://fla-keys.com/lowerkeys) 1.800.872.3722





## Catch Your Reflection in the Bean

No trip to Chicago is complete without the chance to snap a photo at Cloud Gate, affectionately known as “The Bean.” This reflective sculpture in Millennium Park offers a unique RV-friendly adventure. Park your rig on the outskirts of Chicago before hopping on public transit for an easy and enjoyable trip to this downtown icon.



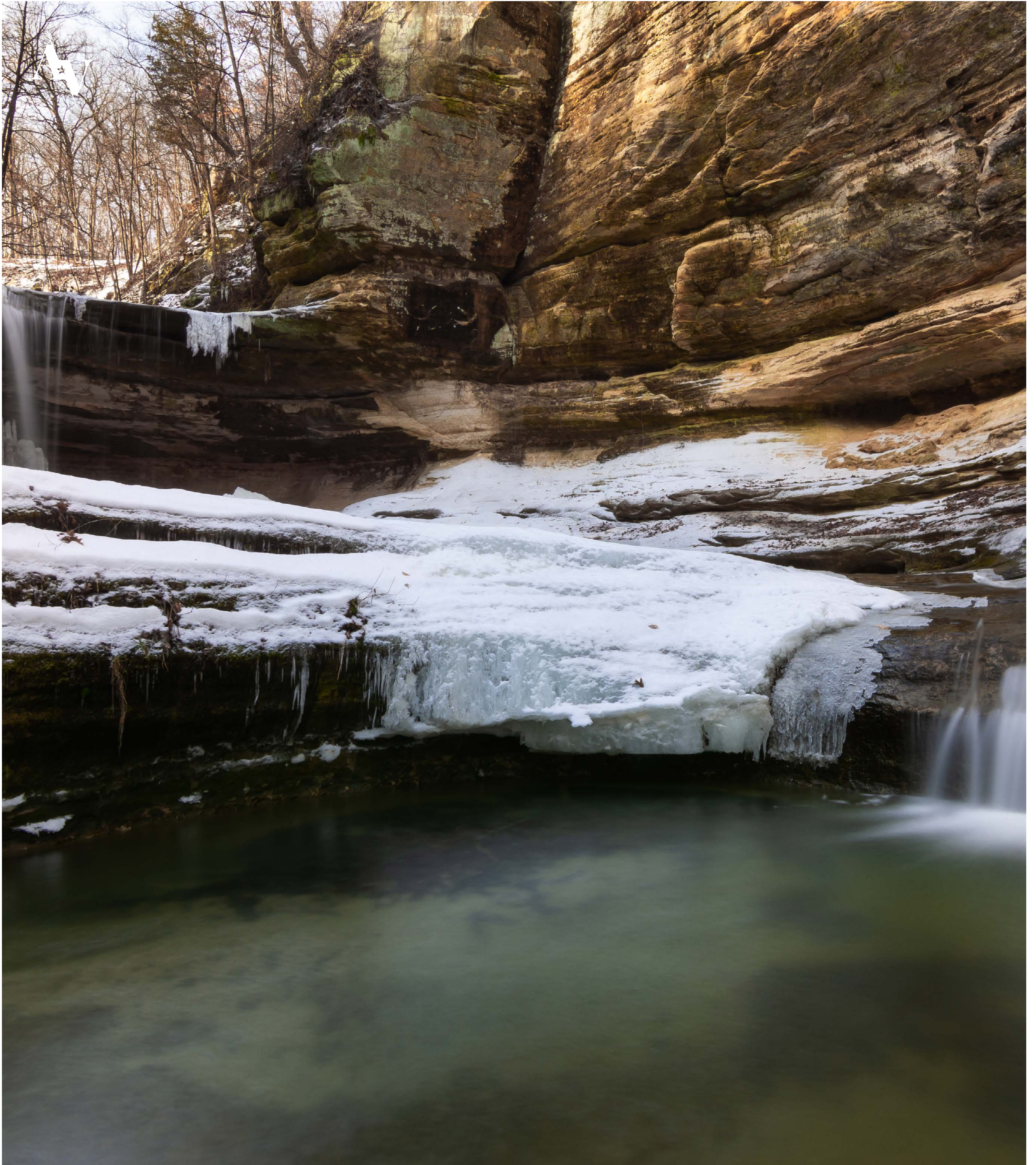

## Exploring the Serene Waterfalls of La Salle Canyon

There's so much to see beyond the Windy City. Just a couple of hours' drive away, you'll find the stunning LaSalle Canyon. This natural area transforms into an enchanting oasis as winter begins to fade. Starved Rock State Park not only provides accessible camping but also a breathtaking base to explore trails through serene canyons to watch the waterfalls as they begin to thaw.





## Capturing Winter's Frozen Beauty

Winter campers are treated to a magical sight in Ottawa Canyon in Starved Rock State Park. Frozen waterfalls create an ethereal landscape that's perfect for a crisp hike before returning to the cozy comfort of your RV.



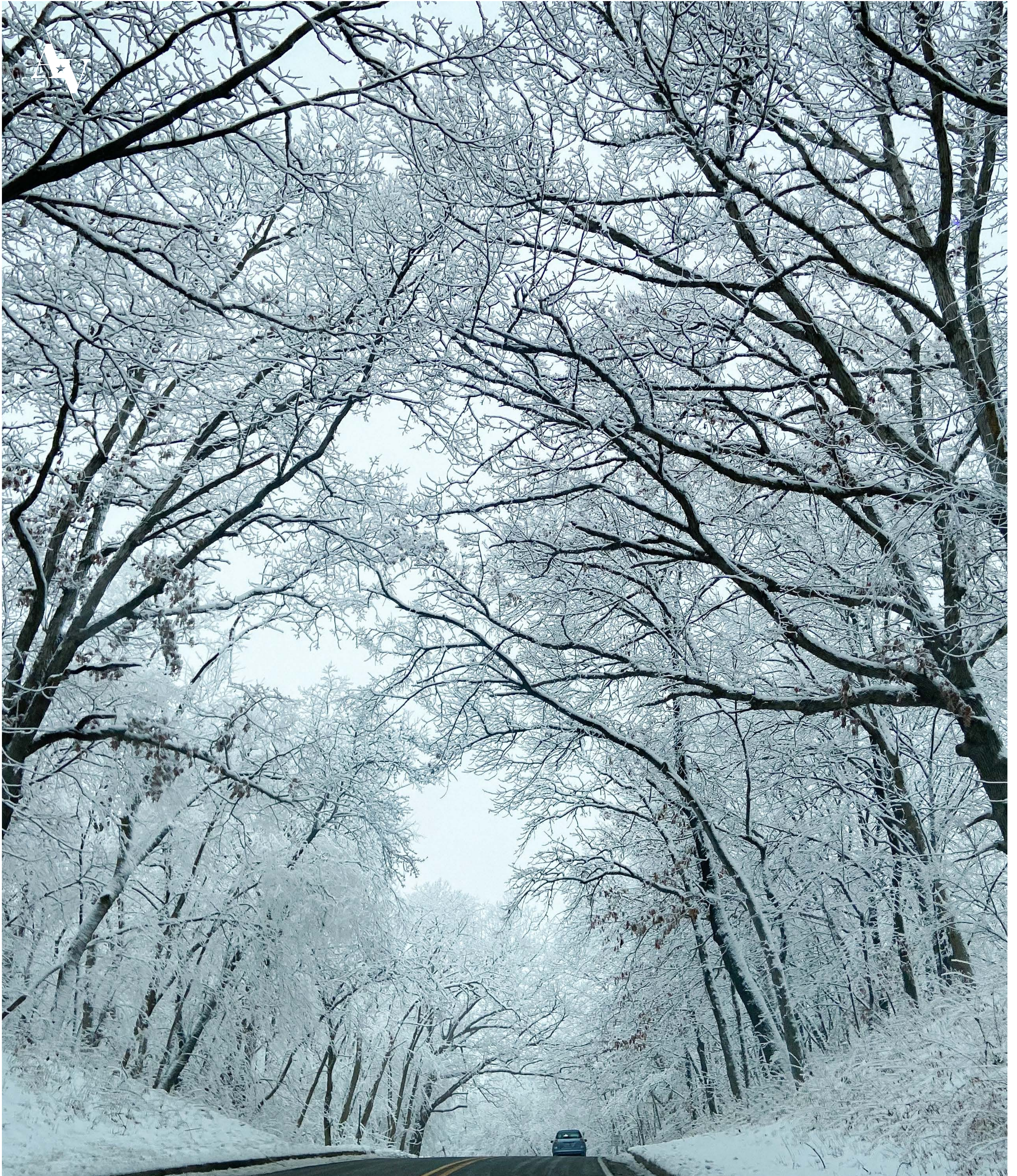

## The Winter Magic of Starved Rock State Park

Driving through Starved Rock in winter feels like stepping into a real-life snow globe. Surrounded by snow and frost-covered trees, quiet trails, and scenic overlooks, this is a top spot for RVers looking to explore a true winter wonderland.





## The Majestic Views from Eagle's Cliff Overlook

Starved Rock's campgrounds provide RVers a lovely chance to wake up early, with a hot beverage in hand, and take in nature's golden hour from one of Illinois's most beautiful settings: Eagle Cliff Overlook.



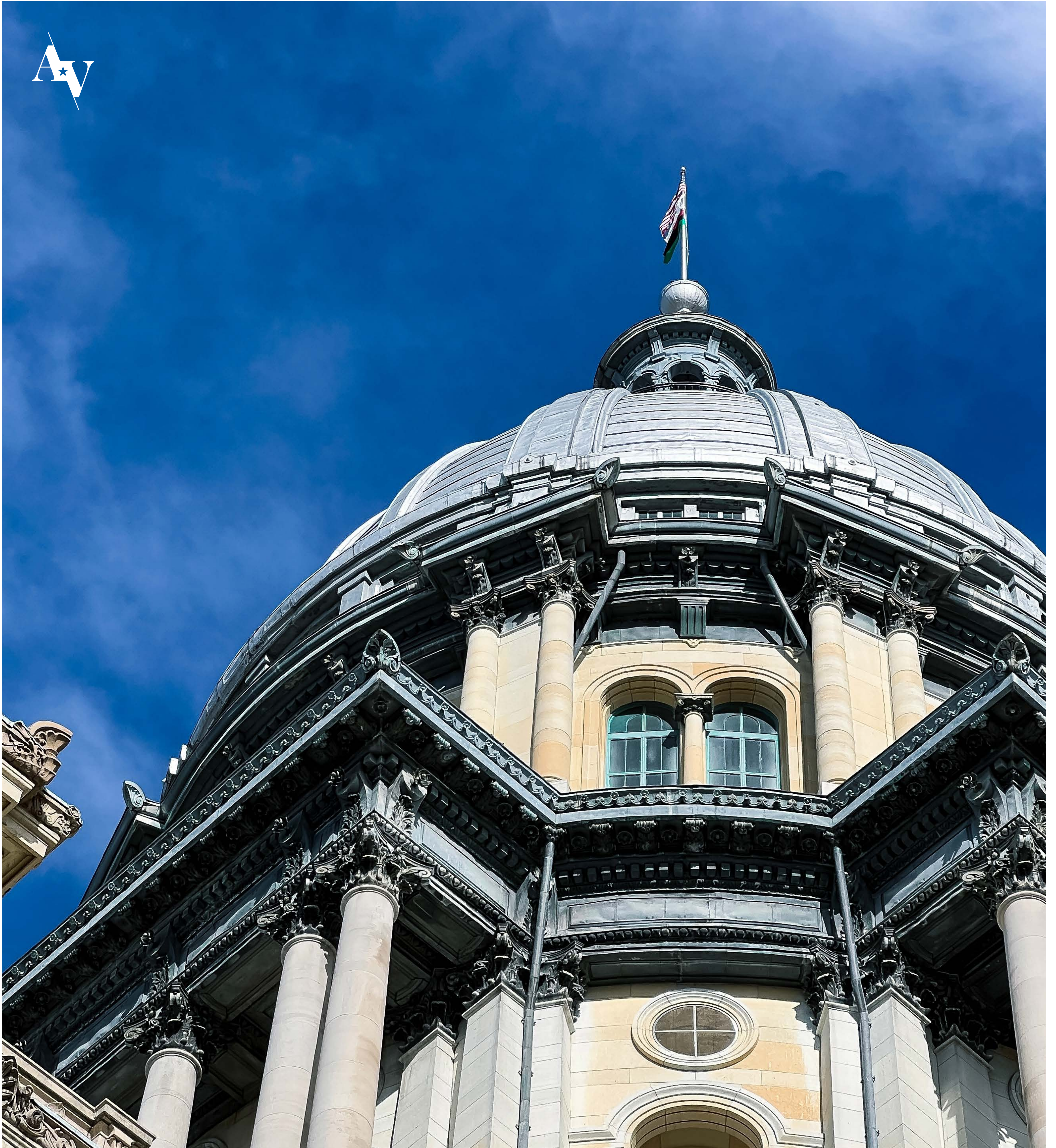

## Uncovering the Secrets of the Illinois State Capitol Building

Head south from Starved Rock to check out the Illinois State Capital building in Springfield. This area offers visitors so much when it comes to history and architecture. The impressive dome of the capital building rises high above the city, and tours invite visitors to experience the area's rich past. Again, convenient RV parks nearby make this an easy stop on your journey through this great state.





## From Grapes to Glass

Continue your journey toward the Illinois-Wisconsin border, and raise your glass to a delightful surprise! The wineries near South Beloit offer tasting sessions surrounded by a stunning backdrop, proving that Illinois has more than just urban and natural wonders to offer.





*Starved Rock State Park isn't just a haven for sightseers. It's a hiker's paradise! There are countless opportunities for RVers to stretch their legs and immerse themselves in nature.*

*Woodland walkways wind through canyons, forests, and riverfronts. Surrounded by cascading walls, French Canyon is a picturesque spot that's just a short hike from main parking areas and is accessible year-round.*

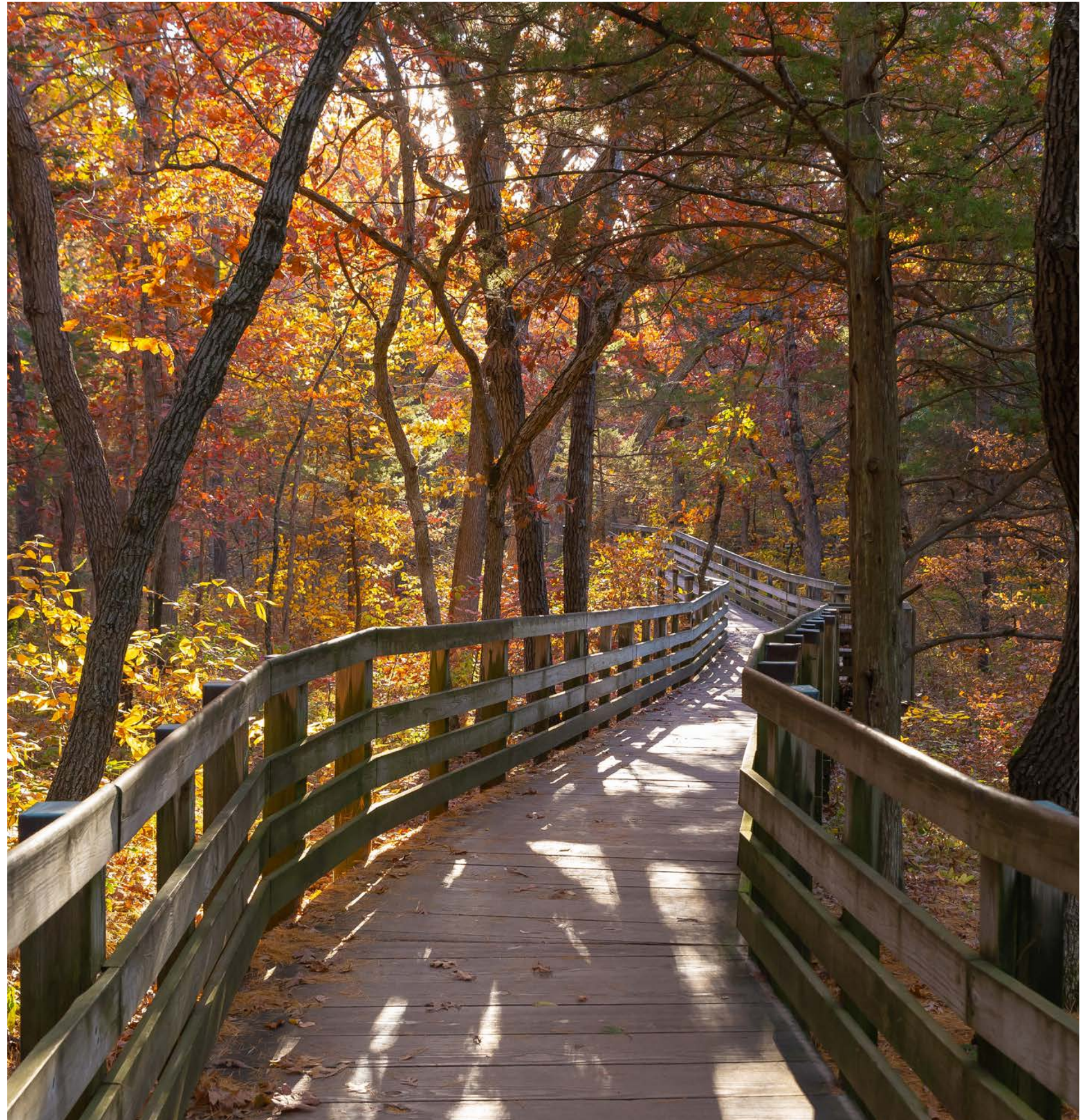



*Looking to escape the crowds? Apple River Canyon State Park provides a quiet and serene landscape made up of rolling hills, limestone bluffs, and riverfront trails for a peaceful retreat in Northern Illinois.*

*If you're looking for a little more excitement, the Chicago Riverwalk blends city energy with scenic charm. Stroll along the water's edge and enjoy eclectic restaurants, shops, and artwork, all while your RV awaits at a nearby campground or park-and-ride.*



*Like any state capital, Illinois' is more than a building: it's a symbol of history and pride. Springfield is an excellent base for RVers, with nearby camping and parking options that make exploring the area's rich heritage a breeze.*



# Road Abode

IMPROVING LIFE ON THE GO

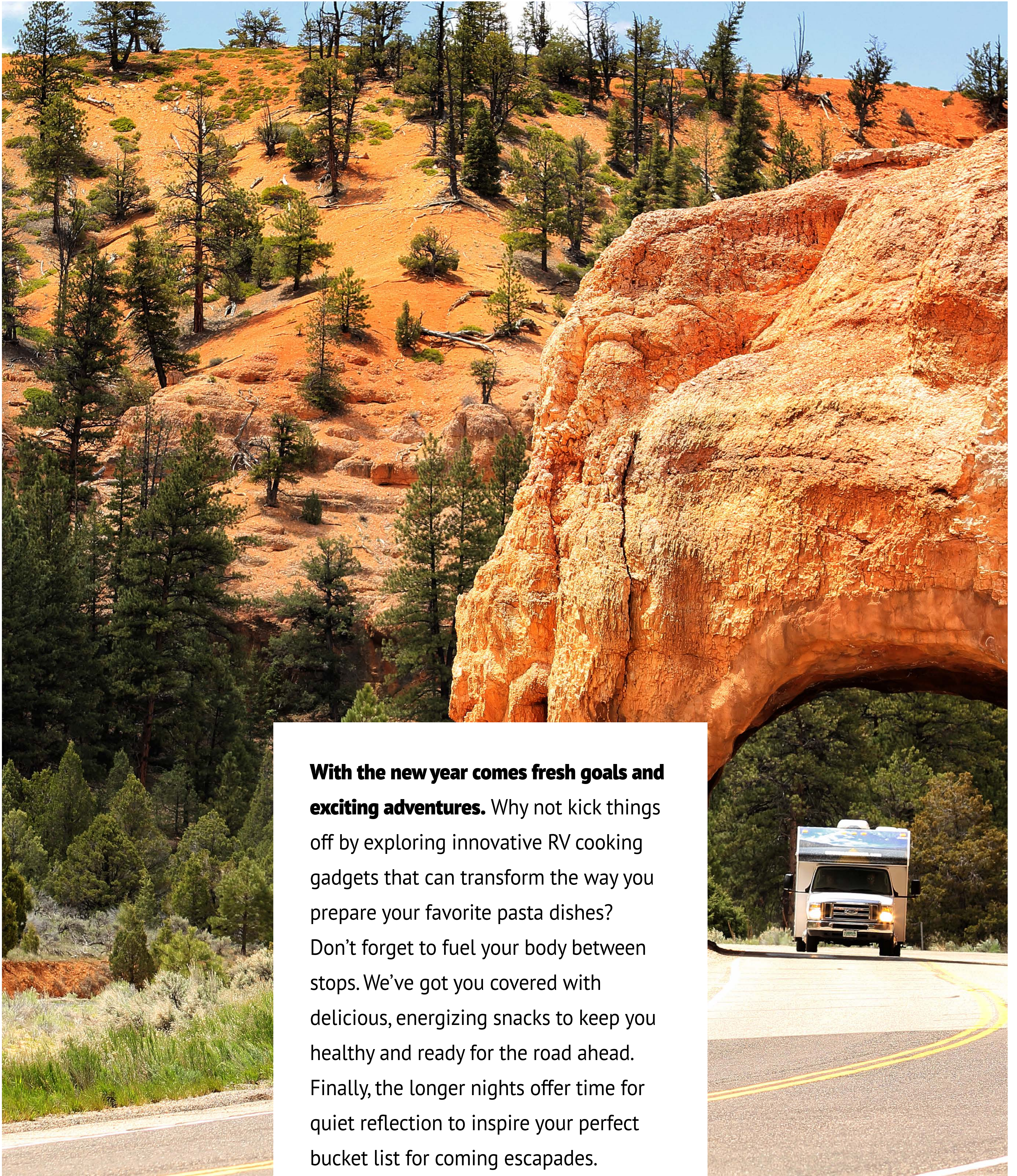

**With the new year comes fresh goals and exciting adventures.** Why not kick things off by exploring innovative RV cooking gadgets that can transform the way you prepare your favorite pasta dishes? Don't forget to fuel your body between stops. We've got you covered with delicious, energizing snacks to keep you healthy and ready for the road ahead. Finally, the longer nights offer time for quiet reflection to inspire your perfect bucket list for coming escapades.

# OTHERWORLDLY NOISE REDUCTION

## The Onan QG 4000i

Enjoy epic peace and quiet with the Onan QG 4000i. With over 100 years of generator experience, Cummins brings you one of the quietest RV generators today. Its EFI variable-speed engine automatically adjusts speed to match the power needed which greatly reduces noise and vibration— even when you're driving between destinations. Discover the generator that everybody will be talking about but few will hear.



Learn more at [cummins.com/generators/onan-qg-4000i](http://cummins.com/generators/onan-qg-4000i)

Pasta

SAVIA



**W**hen it comes to RV cooking, two things are essential: space and convenience. No wonder two unique cookers have become so popular whether you're on the road or at the campsite. Slow cookers and pressure cookers (such as the ever-popular Instant Pot) have both earned their space in any kitchen. And it's all due to their ability to create hearty, delicious meals while taking up minimal space or hands-on time. And that's especially important when cooking in a smaller RV kitchen and having places to go.

Without a doubt, both cookers are also exceptionally versatile. What else is versatile? Pasta! Putting these thoughts together, we've come up with two recipes for a tasty face-off. Both will fill your belly and help warm you from the inside out after a long day's adventure hiking, strolling through town, playing games around camp, or whatever you do to stay entertained!



# Lazy Day Slow Cooker Lasagna

## DIRECTIONS:

1. In a skillet set over medium heat, cook the sausage with the chopped onion until the meat is browned and the onion is soft. Drain off excess fat. Then, stir in the marinara sauce.
2. In a bowl, mix the ricotta cheese, parmesan, egg, and spices until combined. Fold in half the mozzarella.
3. Grab the slow cooker pot and spread a thin layer of the meat sauce on the bottom. Add a flat layer of the uncooked lasagna noodles. (You may need to break them to fit.) Top with a layer of the cheese mixture. Then, repeat the layers, ending with a layer of the meat sauce on the top.
4. Pour a cup of water around the edges of the lasagna.
5. Place the pot into your slow cooker, cover, and cook on low for four to six hours or until the noodles are tender.
6. Sprinkle the remaining cheese on top and cook for 15 more minutes or until the cheese is melted.
7. Remove the pot from the crockpot and allow the lasagna to rest for 10 minutes. Serve (with fresh basil or parsley, if desired). And enjoy!



This recipe is made

for the slow cooker. A device that excels in its simplicity. Just set it and forget it. Head out for a long day of adventure and come home to a piping hot meal!



## INGREDIENTS:

*1 pound ground Italian sausage (you can also use ground beef)*

*1 small onion, finely chopped*

*2 cups marinara sauce*

*1 cup ricotta cheese*

*1 1/2 cups shredded mozzarella cheese*

*1/2 cup grated Parmesan cheese*

*1 egg*

*1 tsp garlic powder*

*1 tsp dried basil*

*1 tsp dried oregano*

*6 lasagna noodles*

*1 cup water*

*Optional: Fresh basil or parsley for garnish*



# Instant Pot Grown Up Mac 'n Cheese

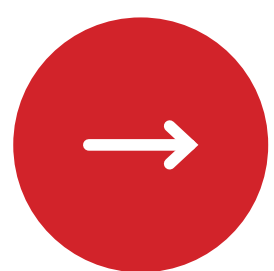

Pressure cookers are all about speed and versatility, delivering rich, complex

flavors in no time. This mac & cheese plays on the tradition but is made for more sophisticated palate.

## INGREDIENTS:

*6 strips of turkey bacon, chopped*

*1 small red onion, diced*

*3 cups mini penne pasta or elbow macaroni*

*3 1/4 cups chicken broth*

*1/4 tsp garlic powder*

*1/4 tsp salt*

*1/4 tsp pepper*

*1 tsp Dijon mustard*

*1 head broccoli, cut into florets*

*1/2 red bell pepper, chopped*

*1 1/4 cups sharp white cheddar cheese, shredded*

*1/4 cup Gorgonzola cheese, crumbled*

*4 ounces cream cheese*

## DIRECTIONS:

1. Sauté the bacon and onion in the pressure cooker (with the cooker's lid off) for 2 to 3 minutes until lightly browned.
2. Add the pasta, broth, vegetables, and spices, and stir.
3. Securely lock the pressure cooker's lid and set to manual for eight minutes.
4. Open the quick release to let the pressure out.
5. Stir in the cheese until it's creamy and melted.
6. Allow to rest for five minutes to thicken before serving.
7. Enjoy!

Which recipe will you try first? Either way, both these recipes and these devices prove how simple it is to elevate your dining without spending hours and bumping elbows in a smaller kitchen space.

# POWER UP

## NUTRITION TO STAY HEALTHY AND ENERGIZED ON THE ROAD

By Cristina Powell

**A**hh, the open road. From towering mountain vistas in the West to the wild and sprawling beaches in the East, there's nothing quite like catching a little white-line fever. Americana at its best. But the road can be long at times. Tedious. What keeps us awake? Caffeine? Sure. But what else?

That's the question we intend to answer.

Whether you're motoring long distances or navigating a full-size RV and setting up camp in a remote area, the road requires a proper diet and snack

regimen. Let's face it: truck stops and fast food aren't the best choices for staying healthy on the road. But it's not hopeless.

So, while caffeine is great for getting us going, it's proper hydration and protein that provide the energy we require to keep going. With millions of Americans on the open road and the rapid expansion of the distribution of goods and products, the availability of healthy options has risen exponentially over the years. In fact, several truck stops and rest areas now have entire sections dedicated to healthy options!

But first things first...

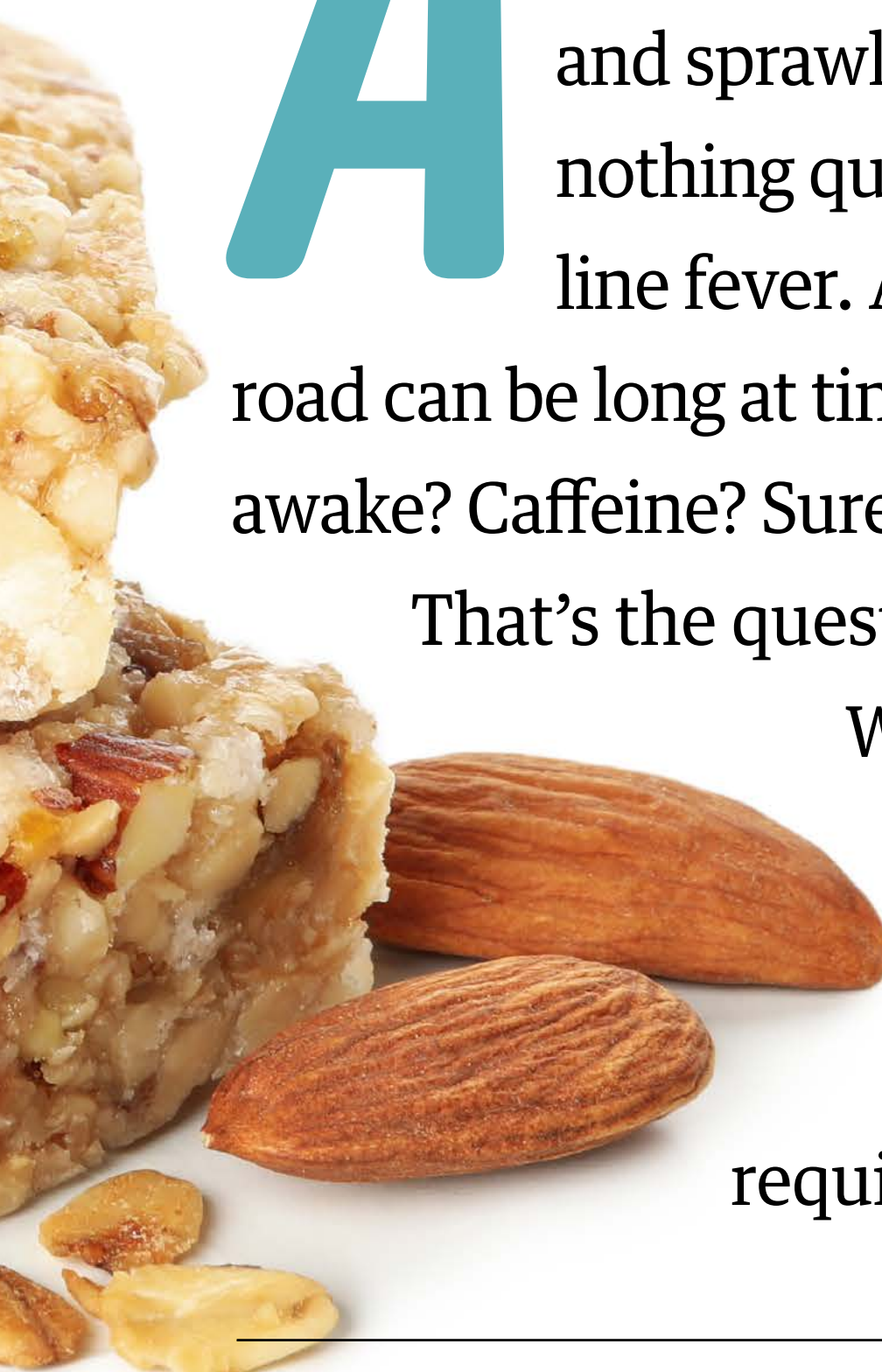

# HYDRATION

When you're getting on the road for hours at a time, proper hydration can be the difference between a comfortable stroll or a series of inconvenient stops due to leg cramps and the need to urinate frequently. It's distracting and annoying, and for what? Not doing something as simple as drinking enough water?

Sixty-four ounces of water per day is the bare minimum for a comfortable ride. And that's, of course, dependent on any number of weather and elevation variables. But if sixty-four is your baseline, you'll find more comfort, longer cruise times, and getting to your destination—be it your in-laws or a campsite in the Joshua Tree National Park—rested and ready.

## NUTS & TRAIL MIX

Now, let's get to the good stuff. Snacks! Who doesn't love road snacks? The trouble is, road snacks have traditionally been made up of greasy, salty chips, crumbly and messy cookies, and teeth-numbing sugar! Okay, okay.

I, too, fancy a candy bar now and again or a bag of spicy chips to munch on. But there are other, often better options.

For instance, keeping a stockpile of nuts and trail mix is an excellent way to accomplish a number of goals. After all, these items are typically sold in single-serving portions, they're high in protein, and they're filling. Bonus: You still get to experience the old-school salty road snack! (And now you know why I started with hydration.)

Nuts and trail mix packs are made for the road to help keep you in balance. They're also a great snack to stash in a pocket or a backpack for a long hike away from camp. And here's a kicker—they pair perfectly with our third category!



**“**  
*NUTS AND TRAIL MIX  
PACKS ARE MADE FOR  
THE ROAD TO HELP KEEP  
YOU IN BALANCE*  
**”**





# PROTEIN BARS & GRANOLA

We all know the words “Protein Bar” in a single phrase don’t tend to conjure childhood memories of a delicious snack. For a long time, these things served a purpose. Provide protein or prevent you from crashing during a long hike or bike ride. Taste was merely an afterthought. But not anymore...

With such a large movement of people more seriously considering what they’re putting in their stomachs, there’s been a variable race to develop healthier options that don’t TASTE like healthier options. And there are some excellent options on the market. (Really!)

## FRESH FRUIT

Okay, so now we’re drinking our water, chomping on our nuts and trail mix, but it feels like we could bring a little more zing to this party. What might compliment this rabble of delicious, healthy snacks, I wonder? How about a banana?! An apple?

Fruit as a road snack is a fantastic option to satisfy a craving. Just imagine it... You’re listening to a great tune, windows down, the air rushing all around you, with your arm half-cocked on the steering wheel, taking a large bite and a long chew of a delicious apple. And as you finish one of those chews, you know—when all the flavor is still there? Throw in a handful of salted cashews (or whichever nut you prefer). The flavor combination is incredible! And you’re packing in vitamins and fiber, too. All the while staying squarely in the middle of your nutritional commitments (and joys).

But let’s say you’re not interested in all that work. Munching on a piece of fruit and backloading with a handful of trail mix can be a bit of a chore, I suppose...



Whether your fix is chocolate, granola and raisins, granola and chocolate, or any combination therein, keeping these handy, fun-sized snack bars around provides a wealth of nutrition, plenty of protein, vitamins, and, yes—a little sugar. But if you're drinking your water and munching on protein bars, you're guaranteed to feel pretty good whenever you climb out of your vehicle!

Still, while we're drinking our water, chomping on nuts and trail mix, throwing in the occasional piece of fruit, or munching on a rich, chocolaty protein bar (which also pairs well with a banana, by the way), we now come to the king of the road...

## JERKY

Let's be honest: jerky has been the king since long before roads were even paved. The hearty, salty, sometimes spicy hunk of chewy goodness (made of beef, buffalo, turkey, chicken, wild game, fish, or even mushrooms) is nice anytime! However, it's especially good when you're out in the world, miles from a sit-down meal. And sure, jerky can be salty (though there are low sodium options), but more and more entire truck stops are basing their very existence on their jerky sales!

But why is jerky the king? Because it lasts. Packing away your favorite jerky provides a constant opportunity to satisfy that salty craving and load up on protein while skipping the energy-depleting refined carbs. In my opinion, no road trip is complete without it!



“  
*JERKY HAS BEEN THE KING SINCE LONG BEFORE ROADS WERE EVEN PAVED.*  
 ”

In summary, it's all about your hydration first, but consider what you munch on because eating the right snacks can be what propels you into setting up a great campsite! ❤️

CREATING YOUR ULTIMATE RV

# Bucket List



# AS

you create your bucket list for RVing, your first thought may be a long list of amazing destinations. Haven't we all made that list? (I know I have—and it grows with every issue.) Yet, for many RVers, the journey is about so much more than the place you park. It's about the experiences along the road.

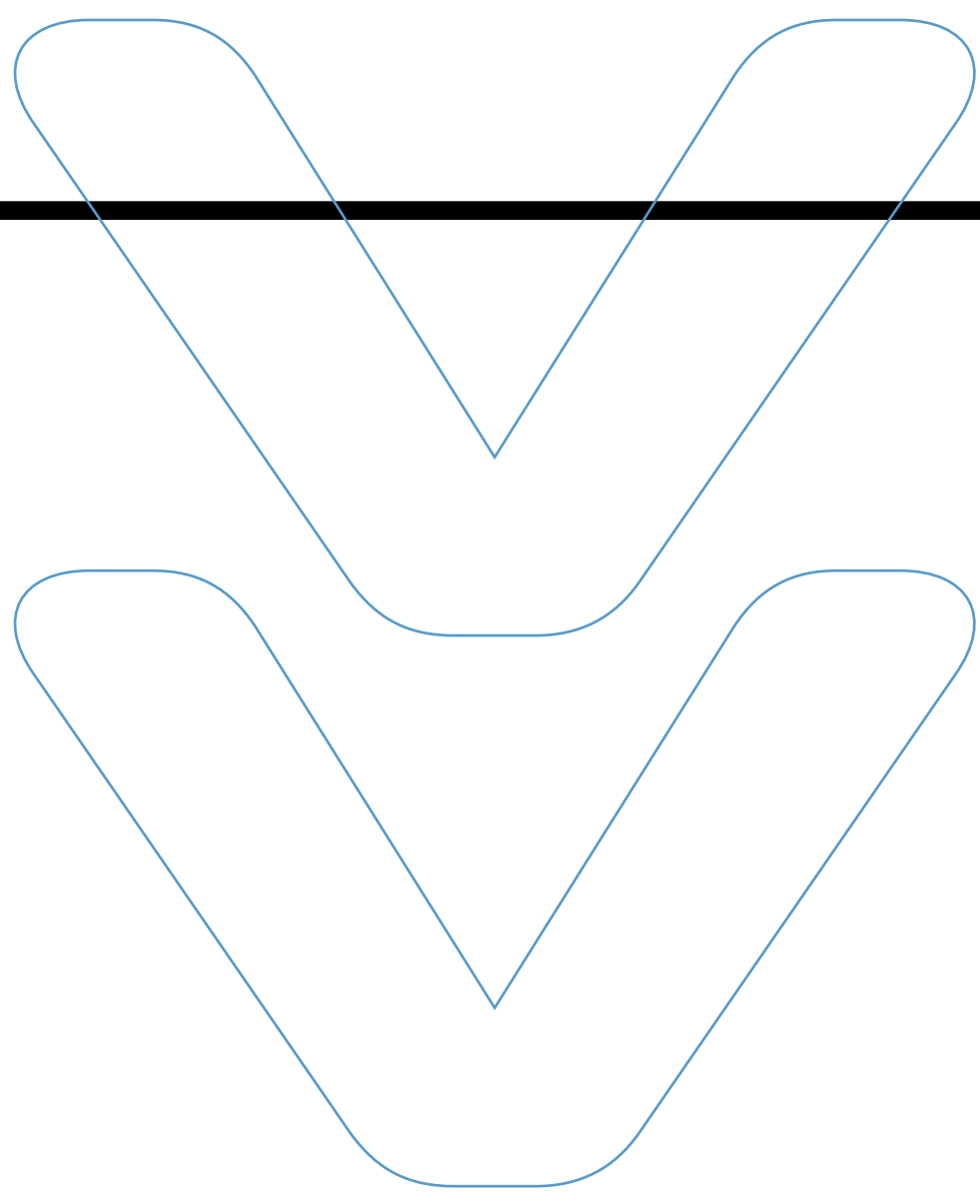

They're what make every trip truly remarkable. From staring up at a peaceful starry sky on a cloudless night to honestly connecting with fellow RVs around a crackling campfire to finding the best hideouts near urban areas—the RV lifestyle is made of unforgettable adventures!

Whether you're a seasoned RVer or getting ready for your first adventure, this bucket list of must-try experiences is designed to inspire you to hit the road and create the types of amazing adventures that last a lifetime.

Where should we begin?!

## NAVIGATING NATIONAL PARKS

If you haven't yet visited your first national park, now is the time to start planning. National parks represent the crown jewels of the RV lifestyle. Throughout the country, you can find breathtaking landscapes, incredible wildlife, and countless trails to explore.

While the first National Park (Yellowstone) was established in 1872, much of the thanks for the expanded network across the country is due to Theodore Roosevelt, often called the Conservation President, who, with a vision to protect wild spaces for generations to come, doubled the number of sites within the National Park System.

With 63 National Parks across the country, it can be hard to choose which one to visit first—to marvel at Old Faithful in the original park, hike through misty trails in the Great Smoky Mountains, capture a stunning sunset at Arches National Park, or explore whichever park is close by.

### Pro Tip:

*National Park campgrounds fill up fast! So, make your reservations well in advance. Or consider boondocking nearby if you're more flexible.*

## CROSSING INTERNATIONAL BORDERS

If you're ready for a whole new level of adventure, you may want to consider grabbing your passport and crossing the border. Picture heading north to cruise through Canada's majestic Icefields Parkway or soaking up the scenic coastal routes in Nova Scotia. You could also head south to discover gems along Mexico's Baja Peninsula. If you're up to crossing borders, you'll open the door to fresh cultures, cuisines, and landscapes.



### Pro Tip:

*Long before you reach the border, make sure you have researched the requirements ahead of time. You'll want to make sure you have the appropriate documents, insurance, and gear for your trip. And if you are crossing with your favorite furry friends, they'll need to meet any health regulations as well.*

## TAKING TIME FOR A LITTLE PAMPERING

Everyone deserves to be pampered from time to time, and RVing allows you to escape rustic accommodations and wilderness adventures for a little luxury from time to time. Throughout the country, you can find resort-style RV parks that offer just a little bit

extra—from long soaks in a hot tub to slow afternoons by the pool, overlooking scenic landscapes, combined with full hook-up sites offering high-speed Wi-Fi. Many even include amenities like golf courses, fitness centers and spas, high-end on-site dining, and concierge services to make you feel truly pampered.

### Pro Tip:

*You can find RV resorts from California to Arizona to Arkansas to Florida (and everywhere in between) that are renowned for their top-tier offerings. You will, however, absolutely need to reserve your spot in advance, and be prepared for a steep price tag.*

## WORKING FOR YOUR CAMPSITE

On the other end of the spectrum, consider camping on a working farm or vineyard. These one-of-a-kind stays connect RVers with farms, wineries, and breweries and offer overnight stays in exchange for supporting their business.

Imagine waking up to fresh air, surrounded by lush landscapes, and sipping on wine or a craft brew in the evening. You can connect with the owners by lifting a hand to help with the farm or business for a fun, immersive experience as you enjoy peaceful surroundings and amazing local products, such as fresh produce, homemade jams, craft beers, and more.



### Pro Tip:

Harvest Hosts and similar programs typically require you to be self-contained as they don't offer hook-ups. So, remember to stock up on water and be ready to use your onboard facilities for a smooth stay. Other potential alternative camping options to check out include Good Sam and BoonDockers Welcome.

offering stunning views and easy access to the water.

If you want to stay inland, you can still enjoy a beach vacation! Gems like Indiana Dunes National Park on Lake Michigan or the sandy shores of Sleeping Bear Dunes, Michigan, can fulfill your need for a beach vacation. Sand Hollow Reservoir, Utah, mixes rich red sand beaches with a dramatic desert backdrop.

**Mountains:** Is there anything like waking up to crisp air and towering peaks with all the abundance of nature surrounding you? You'll find a plethora of campgrounds to explore throughout the Rockies, Appalachians, and Sierra Nevadas—all of which provide access to hiking and biking, wildlife, and scenic vistas.

**Lakes:** If you're looking to enjoy tranquil mornings and perhaps (depending on the weather) delicious dips in cool water in addition to freshwater fishing, laidback kayaking, or relaxing paddleboarding opportunities,

you can find it on the shores of lakes like Tahoe, Crater Lake, Michigan's Great Lakes, and more.

### Pro Tip:

Remember to check your gear. You may need to adjust your RV packing list for each destination. In addition to packing plenty of sunscreen for all destinations, if you're visiting the beach, make sure you grab some swimwear. Add some layers if heading to higher elevations, no matter what time of year. If you want to enjoy water activities, look for easy-to-stow options or rental opportunities at your destination.



## MAKING THE MOST OF NATURE'S MASTERPIECES

Nature provides an abundance of ecosystems, each with its own unique features and charm. And your RV lets you explore them all!

**Beaches:** Enjoy a soothing ocean breeze and sink your toes into the sand by visiting the beaches of Florida's Gulf Coast, Oregon's rugged coast, or the iconic Outer Banks of North Carolina. You won't be disappointed with a visit to one of the many beachfront RV parks





## GETTING TO KNOW A NEW COMMUNITY

One of the greatest things about RVing is the opportunity to immerse yourself in a different community. And there's perhaps no better way to do so than by joining local celebrations. From the lively parades of Mardi Gras in New Orleans in March (the Carnival Season starts in January) to the colorful spectacle of the Albuquerque International Balloon Fiesta in October to the charming small-town vibes of state fairs across the country—festivals of every size in every region offer a chance to taste the local culture, food, and traditions.

Sample regional dishes, enjoy live music, or take part in

unique activities from pumpkin chucking to lantern releases. You'll create cherished memories that will last long after you've driven on to your next destination.

### *Pro Tip:*

*Check your chosen festival's RV parking or camping policies ahead of time. Some provide dedicated spaces. Others may require off-site camping nearby.*

## IMMERSING YOURSELF IN INDIGENOUS CULTURES

The Americas have a long, fascinating, and rich history. Discover the traditions of Indigenous people by visiting landmarks, museums, and cultural centers. Explore ancient cliff dwellings at Mesa Verde National Park, marvel at the petroglyphs in Utah's Nine-Mile Canyon, uplift your spirit at the Medicine Wheel in Wyoming, or visit the First Nations villages in Canada for a deeper understanding of the unique history and perseverance of the people. Seek out cultural centers and historical landmarks

any time you reach a new destination.

These experiences not only provide educational opportunities. They also allow you to reflect on and appreciate the deep connections Indigenous cultures have with the land.

### *Pro Tip:*

*Please be respectful of the spaces, land, and people you visit. Follow local guidelines, ask before taking photos, and support Native-owned businesses and organizations.*

The RV lifestyle offers endless possibilities—not just in where you go but in the journey along the way. RVing provides the opportunity to marvel at the grandeur of national parks, explore stunning landscapes, experience unique campgrounds, and immerse yourself in different cultures.

**This bucket list isn't just a guide: it's an invitation to dream big,** embrace adventure, and live every moment on the road fully. Your ultimate RV adventures are waiting! ❤️

# TOP LEVEL

RV TECH AND TRADECRAFT



**ONE OF THE BEST THINGS ABOUT RVING IS BEING ABLE TO STOP FOR ADVENTURE WHENEVER IT CALLS.** But to make the most of that adventure, you'll want to have all your gear with you. Whether that's a kayak or two, mountain or e-bike(s), motorcycle(s), ATV(s), or a combination, it's not like you can bring your entire toy garage with you. Or can you (within limits, of course)? Enter toy haulers.

 **SYLVAN SPORT GOAT**

If you value simplicity and versatility, the Sylvan Sport Goat stands out for its innovative design. The lightweight frame is perfect for those who prefer off-grid escapades. Its modular design allows for easy customization, so you can pack everything you need without overcomplicating your trip.

**PROS:**

- Ultra-lightweight and easy to tow
- Highly customizable for various needs
- Eco-friendly and durable materials

**CONS:**

- Limited space for larger toys
- Minimal amenities when compared to traditional toy haulers (It's a bit more like camping than RVing.)

57.5"

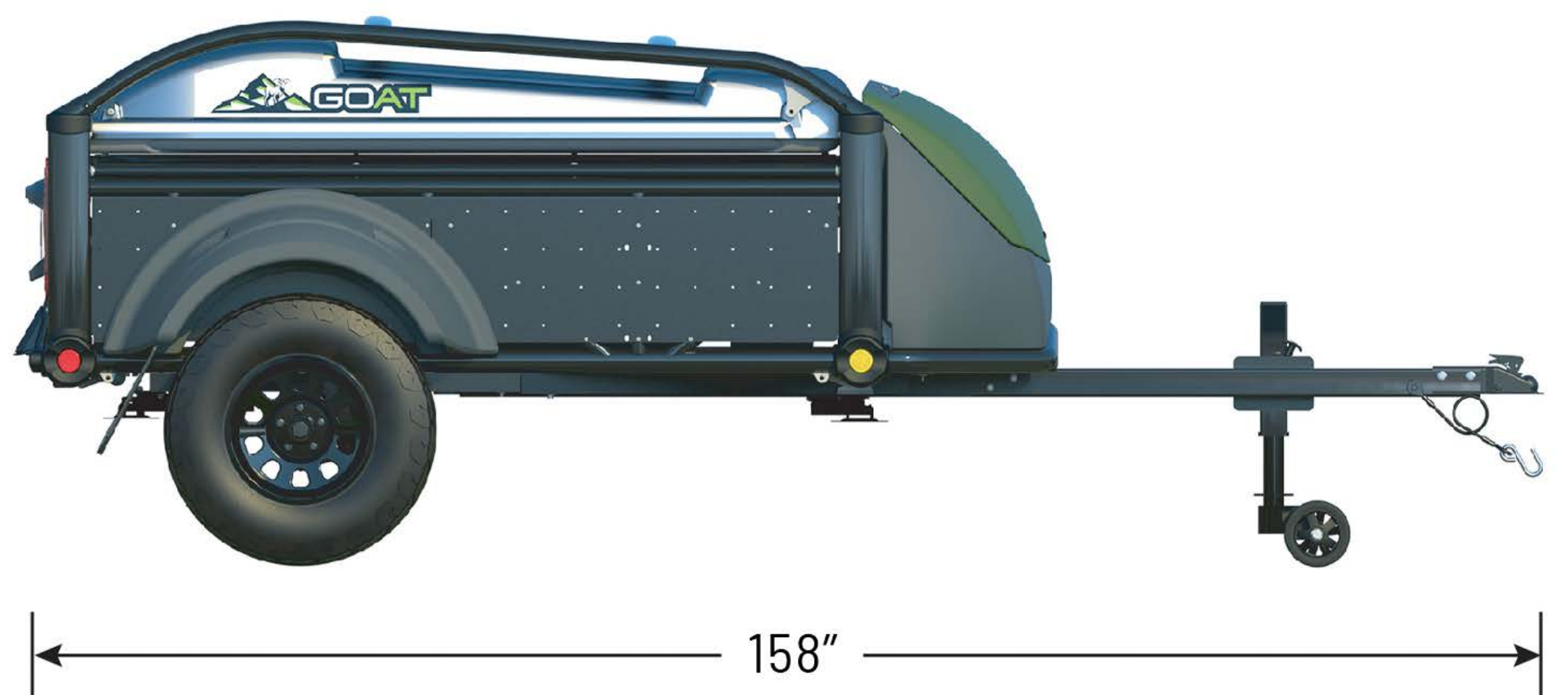
**SYLVAN SPORT GOAT SPECS**

- ▶ GVWR: 2,150 LBS
- ▶ CARRYING CAPACITY: 950 LBS
- ▶ FRESH WATER: OPTIONAL
- ▶ GREY/BLACK WATER: N/A
- ▶ EXT LENGTH: 13' 2"
- ▶ EXT HEIGHT: 4' 9.5"
- ▶ EXT WIDTH: 6' 3.5"

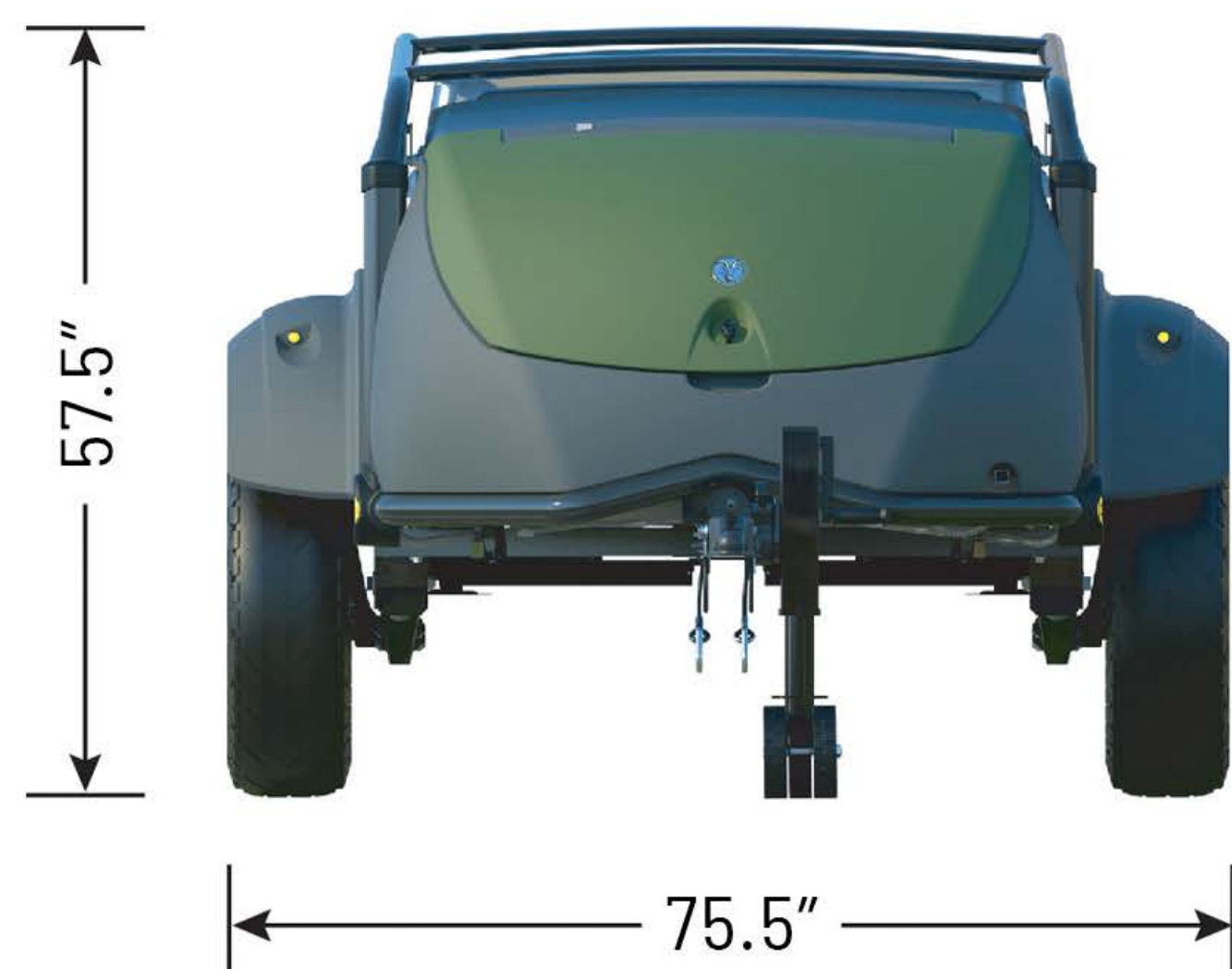

# → VENGEANCE ROGUE ARMORED TOY HAULER

For adventure seekers who refuse to compromise on comfort, the Vengeance Rogue Armored Toy Hauler offers the best of both worlds. With its robust build, spacious garage, off-road capabilities, and high-end features, luxury and ruggedness combine seamlessly for nearly any adventure.



## PROS:

- Large cargo space with tie-downs
- Comfortable sleeping quarters for up to eight people (with two bathrooms!)
- High-quality construction and insulation for all-season use

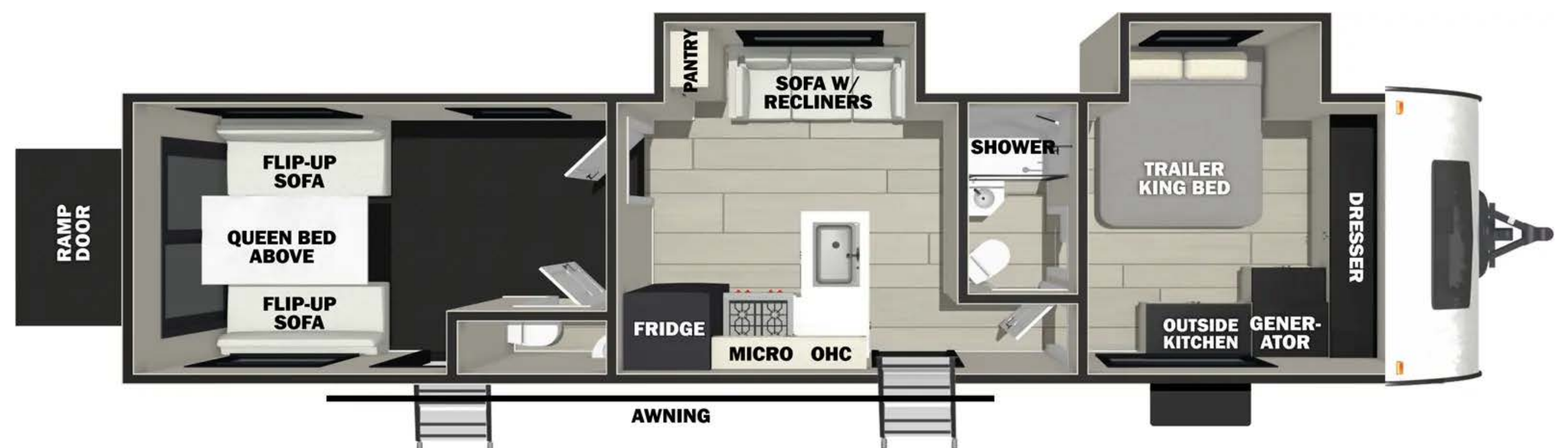

## CONS:

- The heavier weight limits towing options
- Higher price point

## VENGEANCE ROGUE ARMORED TOY HAULER SPECS

(371A13)

- ▶ GCWR: 16,685
- ▶ FRESH/GRAY/BLACK: 150/80/80
- ▶ EXT LENGTH: 43' 4"
- ▶ EXT HEIGHT: 13' 4"
- ▶ EXT WIDTH: 102"



# KZ SPORTSTER

Made for budget-conscious adventurers who don't want to skimp on essential features, this well-thought-out toy hauler fifth wheel has a user-friendly design. For those who also like to entertain, the Party Patio Package provides extra outdoor space that's made for get-togethers.



## PROS:

- Lighter weight and easier to tow
- Budget-friendly
- Practical garage space with convertible seating for entertaining

## CONS:

- Smaller water tank capacities
- Limited luxury amenities

## KZ SPORTSTER SPECS

(353TH13)

- ▶ GCWR: 13,995
- ▶ FRESH/GRAY/BLACK: 75/50/82
- ▶ EXT LENGTH: 40' 6"
- ▶ EXT HEIGHT: 12' 7"
- ▶ EXT WIDTH: 102"

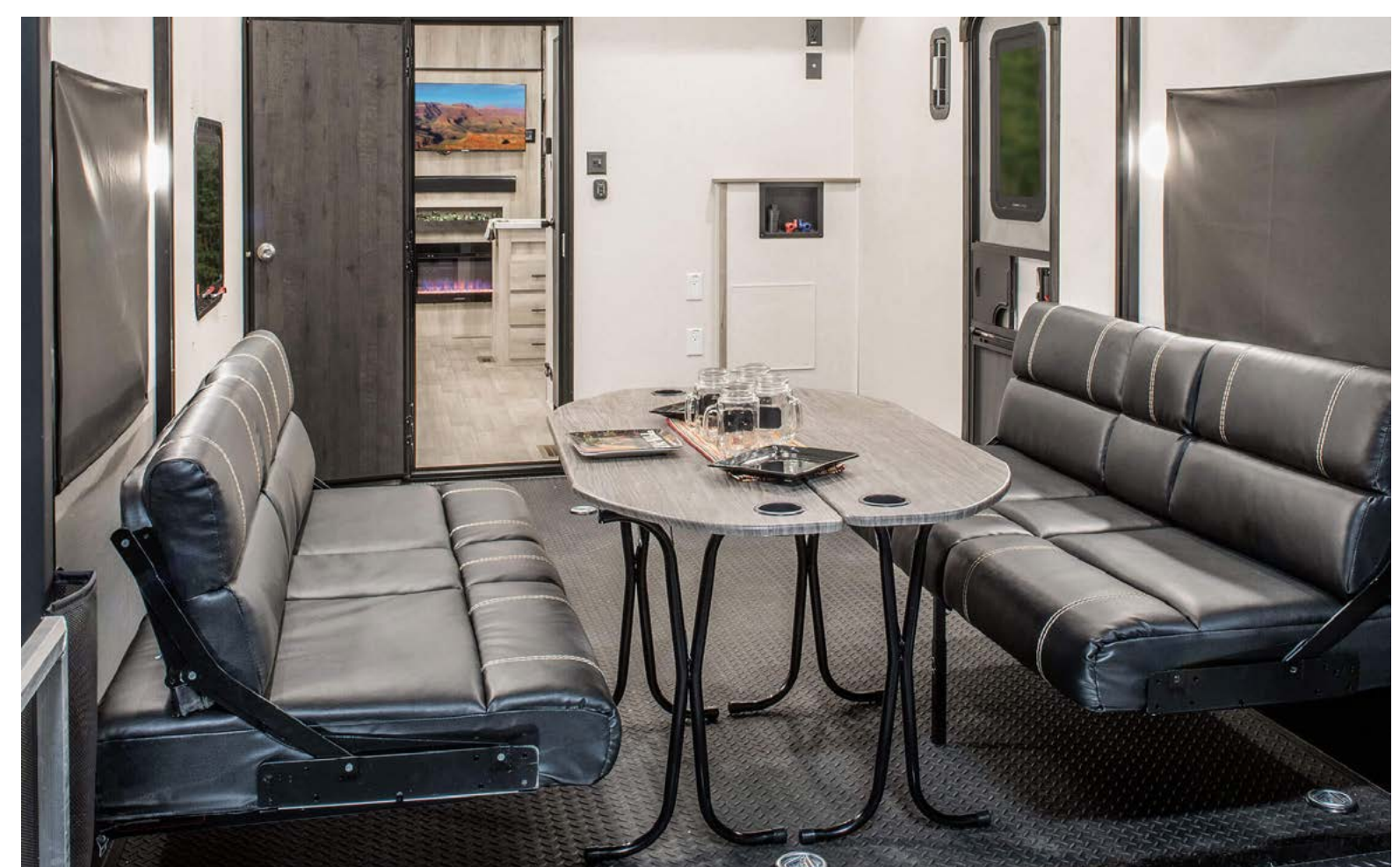
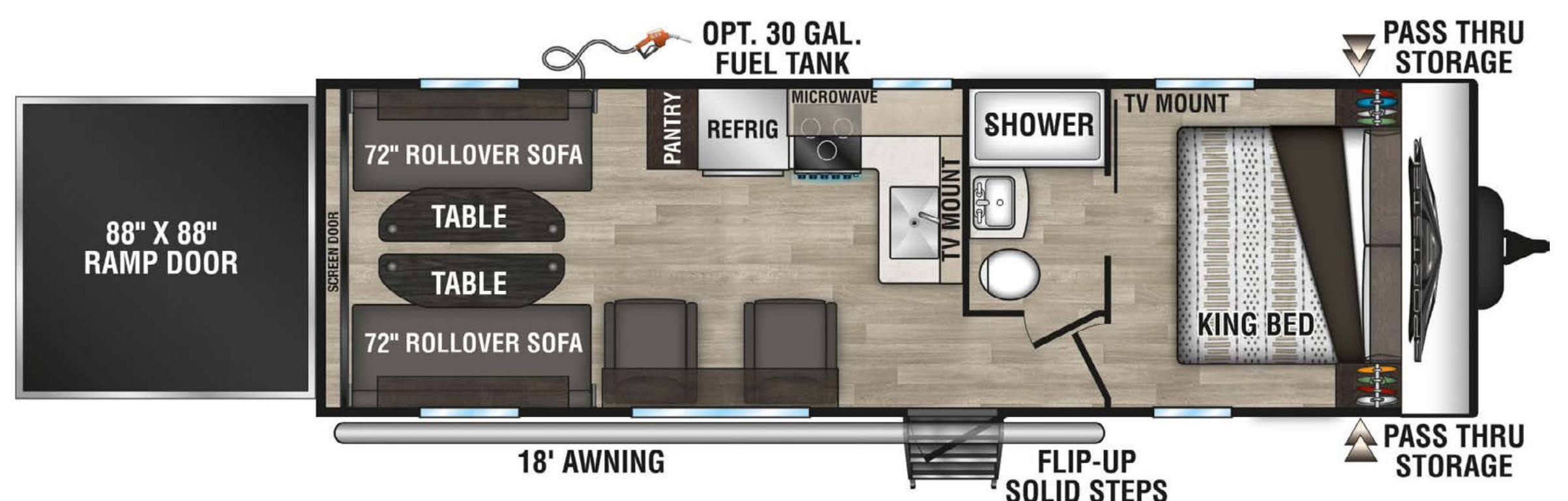

# → FOREST RIVER XLR BOOST

The XLR Boost not only prioritizes storage and usability but it's also built for durability and functionality and offers endless possibilities—from ski trips to sports tournaments to water sports to tailgating to, of course, weekend getaways. That includes a spacious garage with an advanced tie-down system. It also provides a modern interior for RVers who enjoy their rugged adventures but want a comfortable place to rest after going hard.



## PROS:

- Robust construction, suitable for off-road adventures
- Spacious garage with built-in storage solutions
- Modern interior with premium appliances

## CONS:

- Heavier weight may require a larger tow vehicle
- Higher cost compared to similar models

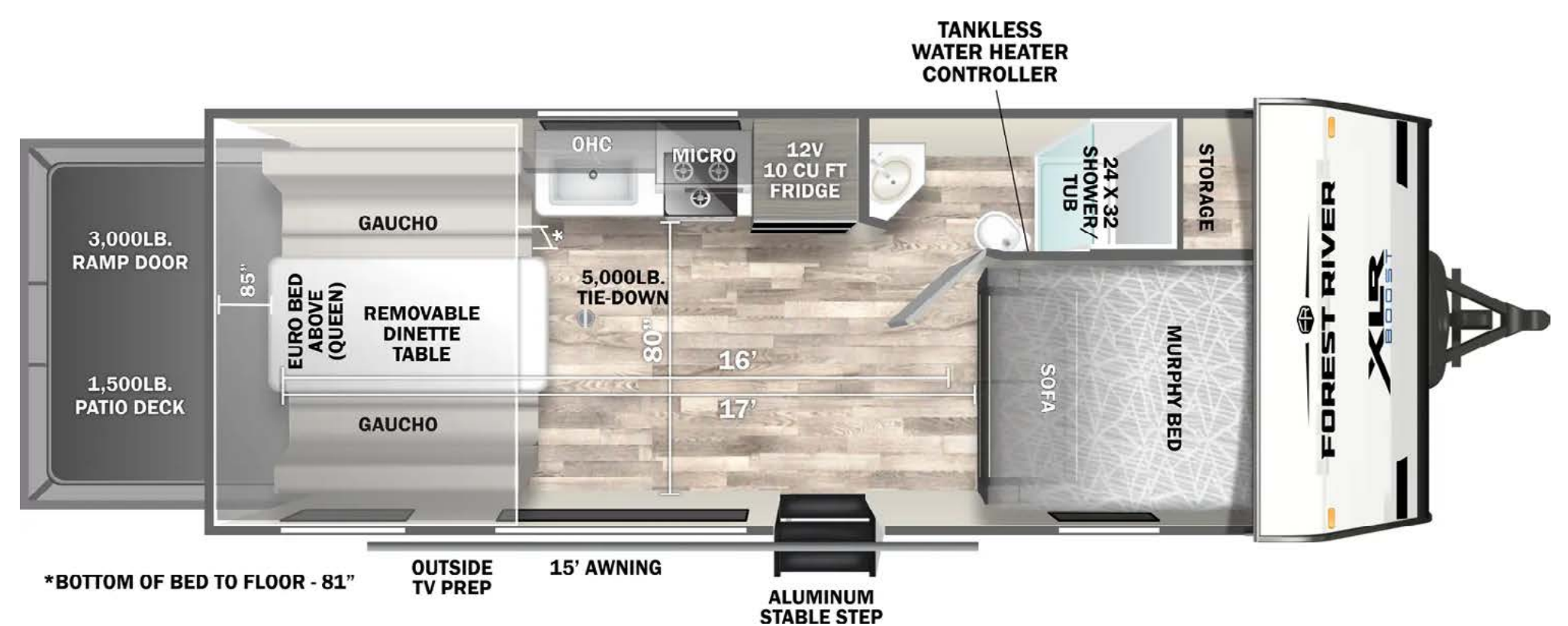

## FOREST RIVER XLR BOOST SPECS

(2017B)

- ▶ GCWR: 6,573 POUNDS
- ▶ FRESH/GRAY/BLACK: 102/32/66
- ▶ EXT LENGTH: 26' 8"
- ▶ EXT HEIGHT: 12'
- ▶ EXT WIDTH: 102"

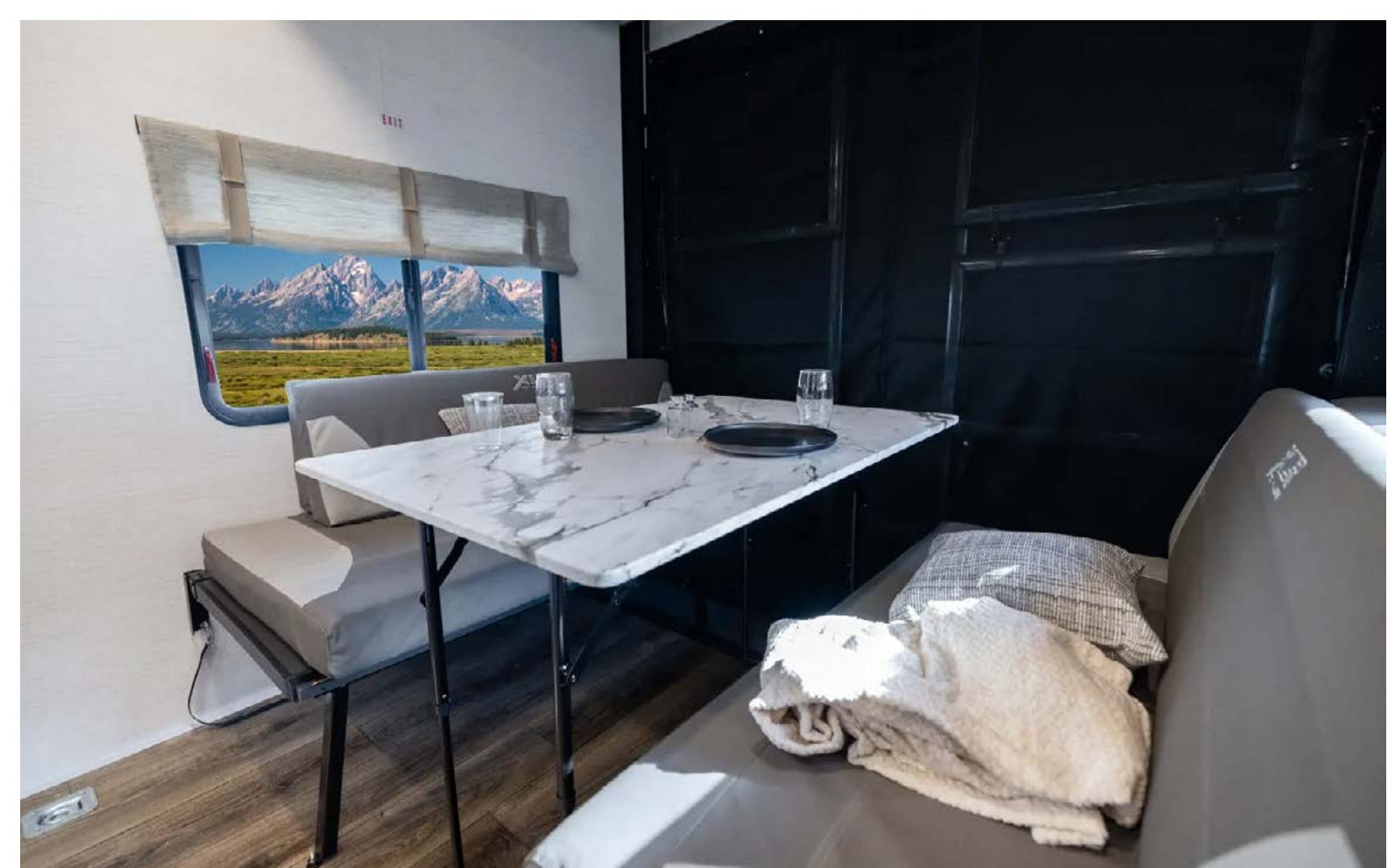

# HEARTLAND CYCLONE

The ultimate luxury toy hauler, offering a wide range of amenities that make it feel like a true home on wheels. Enjoy a massive garage, gourmet kitchen, state-of-the-art entertainment system, and more.



## PROS:

- High-end finishes and luxury amenities
- Ample garage space
- Practical layout
- Excellent insulation for year-round comfort

## CONS:

- Very large size limits campsite accessibility
- Expensive compared to other toy haulers

## HEARTLAND CYCLONE SPECS

(4270)

- ▶ GCWR: 21,000 LBS
- ▶ FRESH/GRAY/BLACK: 150/80/80
- ▶ EXT LENGTH: 46' 4"
- ▶ EXT HEIGHT: 13' 3"
- ▶ EXT WIDTH: 8' 5"

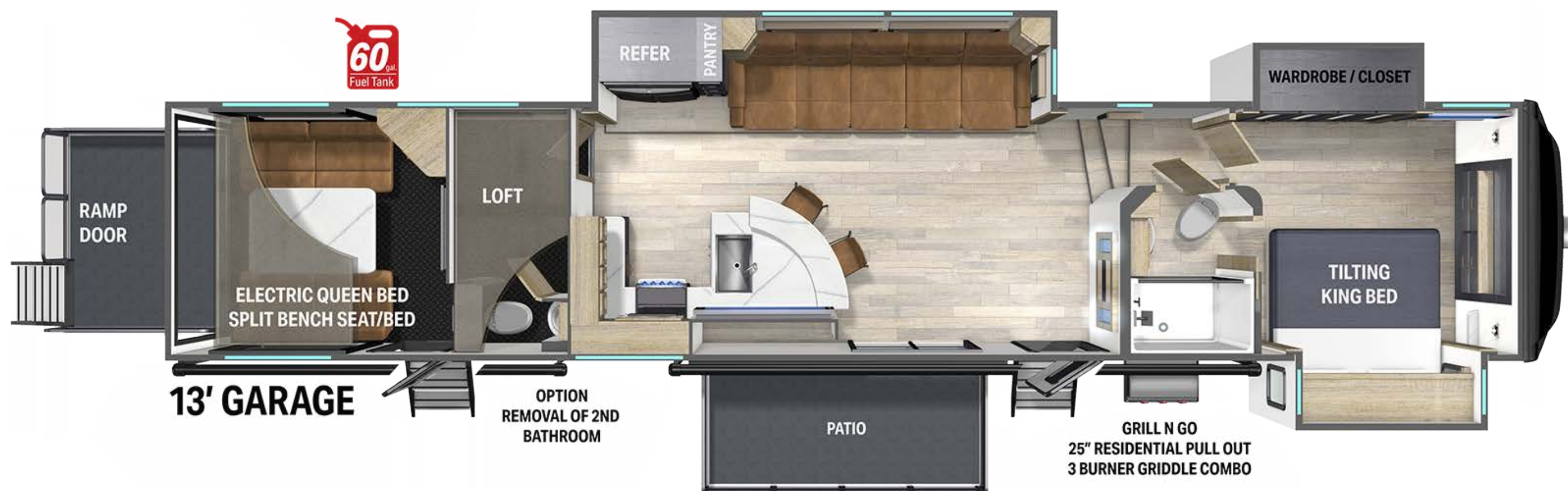

# → KEYSTONE RAPTOR

Designed for adventurers who are looking for a durable and spacious toy hauler, the Raptor offers the right balance of rugged performance and refined living.



## PROS:

- Stylish and comfortable interior
- Advanced suspension system for smooth towing
- Multiple floor plans to suit various needs

## CONS:

- Heavier weight may require powerful tow vehicle
- Higher price tag

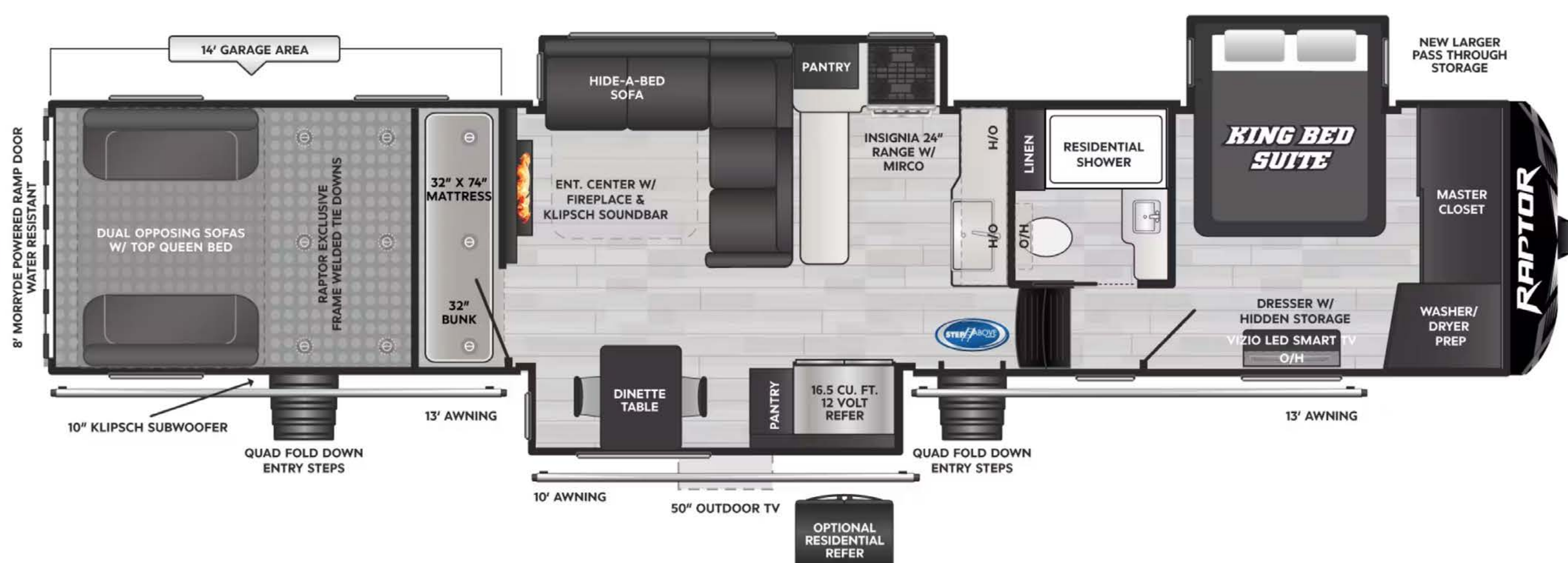

## KEYSTONE RAPTOR SPECS

(441)

- ▶ GCWR: 19,000 LBS
- ▶ FRESH/GRAY/BLACK: 173/104/52
- ▶ EXT LENGTH: 44' 9"
- ▶ EXT HEIGHT: 13' 3"
- ▶ EXT WIDTH: 8' 6"



# → GRAND DESIGN MOMENTUM MAV

Known for getting the details right, the Grand Design toy hauler provides premium features along with storage and durability to keep you comfortable on extended stays as well as short trips. With plenty of space, including a roomy garage, you can play hard and then rest easy.



## PROS:

- Build quality and insulation
- Spacious interior
- Ample garage space, including heavy-duty tie-downs

## CONS:

- While more affordable than many of the other options, it still comes with a significant price tag
- Limited availability of certain floor plans

## GRAND DESIGN MOMENTUM MAV SPECS (24MAF)

- ▶ GCWR: 11,000 LBS
- ▶ FRESH/GRAY/BLACK: 90/74/37
- ▶ EXT LENGTH: 29' 11"
- ▶ EXT HEIGHT: 12' 2"
- ▶ EXT WIDTH: 8' 6"

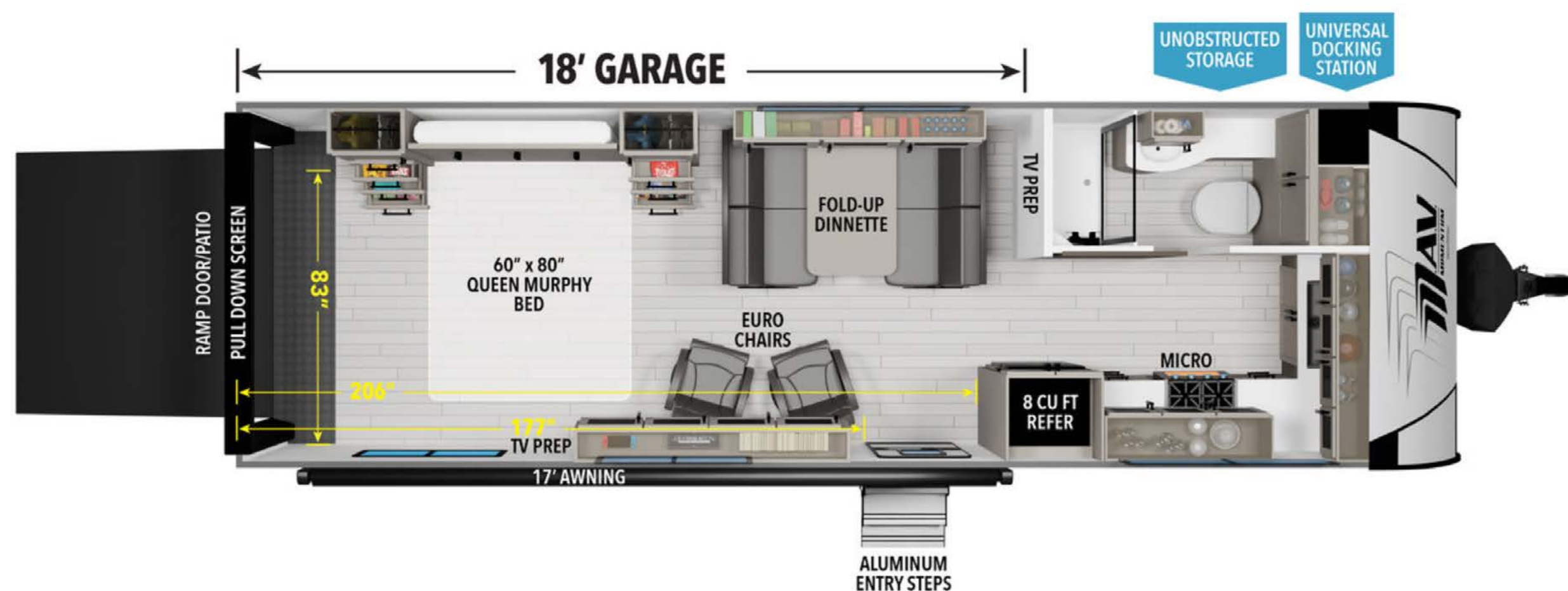

# FOOTM

EDGE  
OF  
THE  
MAP

FROM THE HIGHWAY TO THE CAMPGROUND



*INSIDE: Must-see  
Destinations of 2025*

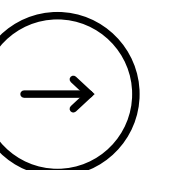



# TOP 25

## RV Destinations for 2025

**F**or adventurous RVers, the United States provides a treasure trove of destinations: from towering redwoods to pristine coastlines, rugged deserts to lush mountain ranges. There's no shortage of incredible places to explore. But with so many amazing options, deciding where to go next can be a challenge—but that's part of the fun, isn't it?! Whether you're looking for natural wonders, cultural hubs, or family-friendly adventures, this list of the top 25 RV destinations has you covered, with each spot offering something unique and unforgettable.



# Northwest

**1**

**Acadia National Park, Maine:** Discover rugged coastlines, quiet forests, scenic drives, and rich cultural heritage. This crown jewel of the North Atlantic Coast is one of the top 10 most-visited national parks for good reason!

**2**

**Cape Cod, Massachusetts:** Enjoy charming seaside towns, sandy beaches, timeless beauty, and relaxing campgrounds perfect for soaking up New England's coastal beauty.

**3**

**Niagara Falls, New York:** Experience the iconic falls, charming communities, and nearby outdoor attractions for an unforgettable adventure.

**4**

**Pine Creek Gorge, Pennsylvania:** Sometimes referred to as the "Grand Canyon of the East," this peaceful spot offers spectacular views of steep canyon walls and beautiful waterfalls with nearby RV-accessible sites.

**Florida Keys, Florida:** Camp right by the water, snorkel in turquoise waters, and enjoy the laid-back vibe of this tropical paradise. Just remember to book your stay well in advance for this popular destination.

**Myrtle Beach, South Carolina:** Combine sandy beaches, a famous boardwalk, golf courses, and loads of entertainment options with RV parks offering prime locations along the coast. Myrtle Beach offers a little of everything for an enjoyable stay.

**Shenandoah National Park, Virginia:** Wind your way along the Skyline Drive and enjoy RV-friendly pull-offs and campgrounds nestled in the Appalachian Mountains.

**Blue Ridge Parkway, Virginia/ North Carolina:** Dubbed “America’s Favorite Drive,” this scenic route is a dream for RVers with plentiful campgrounds and stunning vistas, including cascading waterfalls, wildflower fields, and quiet woods to get you back in touch with nature.



# Midwest

9

**Badlands National Park, South Dakota:** Marvel at otherworldly rock formations, rugged beauty, resilient culture, and prairie landscapes while enjoying RV-friendly campgrounds within or around the park.

10

**Sleeping Bear Dunes, Michigan:** Explore sandy dunes, miles of sandy beaches, scenic trails, and lush forests with nearby campgrounds along the shores of Lake Michigan to fully relax and recharge.

11

**Cuyahoga Valley National Park, Ohio:** Surprisingly close to urban areas (Cleveland and Akron), this hidden gem offers a relaxing refuge, filled with waterfalls, historic sites, and abundant native plants and wildlife. All accessible by convenient RV parking options close to the action.

12

**Door County, Wisconsin:** Quaint villages, waterfront views, and lush landscapes make this a top choice for RVers seeking a peaceful getaway. With 300 miles of shoreline, you're never far from your favorite water sports.

# Southwest



# 13

# 14

# 15

**Grand Canyon National Park, Arizona:** Experience one of the world's greatest natural wonders, with 278 miles along the Colorado River surrounded by mile-deep canyon walls and unmatched vistas. RV parks and campgrounds are conveniently located near the iconic South Rim for an unforgettable adventure.

**Santa Fe, New Mexico:** Immerse yourself in the unique art, culture, history, outdoor experiences, and cuisine of this legendary and beloved desert city.

**Zion National Park, Utah:** Stroll through towering red cliffs and lush canyons, knowing you're following the paths of ancients who walked these trails for thousands of years. The brilliance of the blue sky is breathtaking contrasted with the massive sandstone cliffs.



**Yellowstone National Park,  
Wyoming/Montana/Idaho:**

The first national park offers geysers, paint pots, and other unique hydrothermal and geologic features, as well as abundant wildlife and a landscape like no other.

**Grand Teton National Park,**

**Wyoming:** Enjoy breathtaking mountains teeming with wildlife, serene lakes, and so much more. Several well-maintained RV-friendly campgrounds surrounded by awesome views make this a truly inspired trip.

**Mesa Verde National Park,**

**Colorado:** Explore ancient cliff dwellings, stunning vistas, and the fascinating history of the Ancestral Pueblo people.

# Rocky Mountains

**Crater Lake National Park,**

**Oregon:** Camp near the deepest lake in the U.S., surrounded by awe-inspiring volcanic scenery in one of the most pristine places on Earth. Gaze in wonder atop the stunning Cascade Mountain Range.

**Olympic National Park,**

**Washington:** With an incredible range of elevation and rainfall, you'll find a diverse landscape of rainforests, mountains, and coastlines in the nearly one million acres of wilderness.

19

20



# *Pacific Northwest*



# California

**21****22****23****Yosemite National Park:**

Taste the tranquility of the High Sierra Mountain range. Iconic granite cliffs, waterfalls, and RV-accessible campgrounds make this a bucket-list destination.

**Redwood National and**

**State Parks:** You won't only walk among ancient giants through the world's tallest trees; you'll also experience open prairies, oak woodlands, and unusual wildlife, including California condors.

**Joshua Tree National**

**Park:** Enjoy the unique desert landscape where two distinct desert ecosystems meet. You'll find a fascinating variety of resilient animals and plants as well as dark, clear night skies for a surreal experience in nature.

# Alaska



24 | 25

**Denali National Park:** Spot wildlife, enjoy stunning mountain vistas, and explore millions of acres of untamed wilderness from well-equipped RV campgrounds to experience unmatched solitude and tranquility that can be so difficult to find in today's busy world.

**Kenai Fjords National Park:** Park your RV in nearby Seward and take in the awe-inspiring glaciers and marine life of this coastal gem where mountains, ice (nearly 40 glaciers!), and ocean meet.

*RVing isn't just about getting from point A to point B—it's about the journey, the experiences, and the memories made along the way.*

*These 25 destinations showcase some of the best of what RV travel has to offer, from the serene to the spectacular. So, pack your rig and set your sights on one (or more!) of these incredible spots for your next adventure. No matter which destination you choose, the road ahead promises endless opportunities for exploration, connection, and unforgettable moments. ❤️*

# RVX



**INSIDE:** The slow cooker vs. the pressure cooker ... how do these space saving wonders stack up?

CAMPING, ADVENTURE, AND THE RV EXPERIENCE

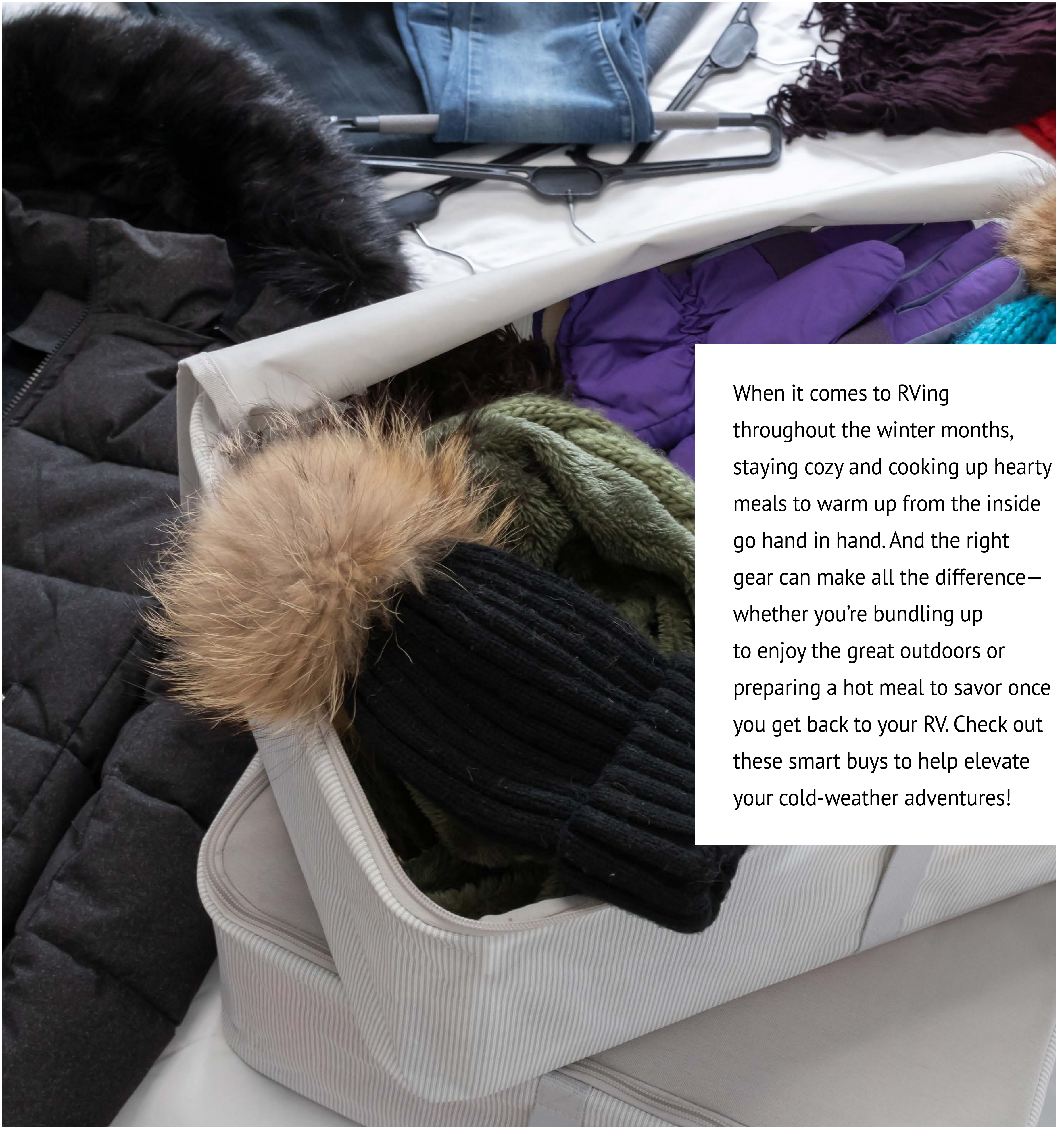

When it comes to RVing throughout the winter months, staying cozy and cooking up hearty meals to warm up from the inside go hand in hand. And the right gear can make all the difference—whether you're bundling up to enjoy the great outdoors or preparing a hot meal to savor once you get back to your RV. Check out these smart buys to help elevate your cold-weather adventures!



# SLOW COOKER

## VS

# PRESSURE COOKER

MOUTHWATERING MEALS WITH MINIMAL EFFORT



# W

hen you're on the road, your kitchen might be small, but your appetite for delicious meals certainly isn't. Enter two unique RV cooking heroes: the slow cooker and the pressure cooker. These compact kitchen gadgets make it possible to whip up mouthwatering meals with minimal effort and even fewer pots. (Fewer dishes for the win!)

Which one should you choose to equip your RV? Let's dig into the details.

## SLOW COOKERS: LOW AND SLOW FOR LAZY AND NOT-SO-LAZY DAYS

Who doesn't love the idea of tossing ingredients into a pot before hitting the trail, pool, or hammock, only to return several hours later to the sweet aroma of dinner ready to serve? That's where the slow cooker comes in. It's as close as most of us will ever get to having a personal chef on board.

Toss all the ingredients into the pot for delicious chili, set your slow cooker on low, and head out on a long hike or a day of paddleboarding or pickleball. By the time you get back to your RV, all you need to do is shred some cheese or chop some red onion. Dinner served. It's almost like magic!

*What to look for in an RV-friendly slow cooker:*

**Compact Size:** A 3- to 4-quart model is ideal for most RVers. This size offers enough capacity to fill up your belly without hogging too much precious space.

**Programmable Settings:** A timer with an auto shut-off feature ensures your stew doesn't turn into mush (or lava) while you're out on your adventure or fall asleep in your hammock. (No judgment here!)

**Lightweight Build:** You can only pack so much in your RV—weight is always a consideration. So, opt for a model that's easy to store and won't test the limits of your RV's weight capacity (or make you choose to leave something else behind).

Some top picks to consider include the compact, easy-to-use, and affordable Crock-Pot® 4-Quart Smart Cook & Carry Cooker. It's a great option for RVers who are looking for simplicity and reliability.

The Hamilton Beach® 6-Quart Programmable Slow Cooker is a fantastic choice for larger families. This model also includes multiple cooking options along with a locking lid for spill-free travel.

Another quality option for individuals or small portions is the Elite Gourmet MST-250XS. However, this 1.5-quart mini slow cooker lacks the automatic settings, so you may want to set an alarm in case you do fall asleep in that hammock.



*Crock-Pot 4-Quart Smart Cook & Carry Cooker*  
Amazon: \$69.99



*Hamilton Beach® 6-Quart Programmable Slow Cooker*  
Amazon: \$69.99



*Elite Gourmet MST-250XS*  
Amazon: \$14.39

## PRESSURE COOKERS: SPEED PLUS VERSATILITY

The pressure cooker is like having a sous chef with a jetpack. You can prepare everything from tender pulled pork for your BBQ (in around 40 minutes) to perfectly cooked rice in as little as five. There are so many options for fast meals when it comes to these amazing devices!

What to look for in a pressure cooker:

**Multi-functionality:** Forget the old-school stovetop models and go for one that can sauté, steam, slow cook, and even make yogurt. You'll have fewer gadgets to pack and greatly expand what you can make at camp.

**Portability:** Depending on your family's size (or if you're going solo), 3 to 6 quarts provide plenty of capacity and a small footprint, so you don't use up all your counter space.

**User-friendly features:** Look for clear displays and preprogrammed settings, especially if you're new to pressure cooking.

One popular model to consider is the Instant Pot Duo 3-Quart Mini Multi-Use Pressure Cooker (also available in a 6-quart size). This compact and powerful unit is popular with RVers as it does it all. You can quickly prepare anything from soups to chili to meats to sides to decadent desserts. It also has settings to delay the start or keep warm so you can enjoy your meals on your schedule.

While the Instant Pot remains a favorite, the Ninja Foodi 6.5-quart 10-in-1 Pressure Cooker has gained a loyal following. Not only is it slightly larger, but it also has air frying and crisping settings and can be used much like an oven for endless meal options. It's like your traditional pressure cooker's overachieving cousin who loves to read and is good at math and football!

If you can't decide between a slow cooker and a pressure cooker, why not get both in a single device? The Crock-Pot Express Crock Multi-cooker might be your all-in-one RV solution with 13 one-touch programs from slow cook to sauté to simmer to steam and more.



*Instant Pot Duo 3-Quart Mini Multi-Use Pressure Cooker*  
Amazon: \$79.99



*Ninja Foodi 6.5-quart 10-in-1 Pressure Cooker*  
Amazon: \$159.99



*The Crock-Pot Express Crock Multi-cooker*  
Amazon: \$169.87

Enjoy a full-roasted, flavorful chicken that tastes like it's been in the oven for hours—when it only took 45 minutes! Your RV neighbors may wonder if you're a gourmet chef. (Go ahead and let them; we won't tell!)

## WHICH SHOULD YOU PICK?

In the past, the choice may have been one or the other: hearty hands-off meals with a slow cooker or fast, versatile one-pot meals with a pressure cooker. Today, with so many

impressive combo devices available, you don't have to choose. You can get all the above with just one gadget to become the ultimate RV chef.

Whether you choose a slow cooker, a pressure cooker, or a combo device, you'll free up your time to explore, connect with nature and friends, or enjoy a lazy day at camp. Go ahead and get lost in time. These cookers are here to make your meal prep a breeze and your dinners as memorable as the journey itself.

*Bon appétit!* ❤️



# winter warmth

KEEPING WARM  
AND COMFORTABLE  
ON YOUR RV  
ADVENTURES



With winter winds and snows blowing throughout much of the U.S., the right gear can make a big difference between enjoying frosty adventures and shivering through the season. At the heart of staying warm and dry on the road is selecting the perfect winter jacket. The best winter jackets of 2025 balance warmth, comfort, versatility, and style for your unique needs.

Of course, whether you shop online or in person, you'll be faced with countless options. And narrowing down your choice can feel overwhelming. You can quickly get bogged down with paralysis of analysis. Fortunately, understanding the key features, including down vs. down-alternative jackets, the importance of insulation quality, and style considerations can make the decision easier.

When it comes to insulation, the first question often is: down or down-alternative? Known for exceptional warmth-to-weight ratio, down jackets are crafted using natural feathers, typically goose or duck. Down is incredibly lightweight, compressible, and ideal for cold, dry climates. However, it can lose its insulating properties when wet, so if you're RVing somewhere with unpredictable weather, you'll want to look for jackets with water-resistant treatments.

The other common choice is down-alternative jackets. Made with synthetic materials, these jackets mimic the warmth and loft of natural down. Plus, they may perform

better in damp conditions. They're also often more affordable. While they may be slightly bulkier or less packable than natural down, modern technology has begun to close the gap in warmth and durability.

Whether you choose a down or down alternative, the quality of the insulation matters. Look for features like fill power (for down) or insulation weight (for synthetic).

For down jackets, fill power is a measure of how fluffy and insulating the down is. Higher numbers, such as 700 or 800, indicate better



warmth and efficiency, making these jackets perfect for chilly nights by the campfire or winter hikes.

In down-alternative jackets, the weight and density of the synthetic fill often dictate its warmth. Premium materials like PrimaLoft or Thinsulate offer high performance with excellent water resistance, ensuring you stay cozy even when conditions are damp, if not downright soaking.

Winter jackets aren't just about warmth—they're also about complementing your

lifestyle and preferences. For RVers, space is at a premium, so versatile jackets are a must. Look for features like removable hoods, adjustable hems, or three-in-one designs that combine a weather-resistant shell with an insulated liner. These allow you to adapt to changing conditions, whether you're skiing the slopes or enjoying a mild winter day around the campsite.

From sleek, minimalist designs to rugged outdoor aesthetics, your jacket should reflect your taste while serving its purpose. Neutral tones like black, navy, or gray are timeless and easy to pair, while brighter colors or patterns can help you stand out on the trails.

With these considerations in mind, finding the perfect winter jacket becomes less of a chore and more of an opportunity to invest in your comfort, style, and adventure. In the sections ahead, we'll dive into the best winter jackets for 2025 geared toward RVers to meet a variety of needs, climates, and budgets. Let's ensure your next cold-weather journey is as warm and stylish as it is unforgettable!



## TOP WINTER JACKETS FOR WOMEN: WHERE STYLE MEETS WARMTH

When it comes to women's winter jackets, balancing warmth with style is essential. In 2025, top brands have refined their offerings to accommodate diverse needs, ensuring every adventurer can find her perfect fit.

Popular choices like the Patagonia Down With It Parka offer a sleek silhouette and extended length to keep you cozy.

They're made with responsibly sourced down insulation to keep wearers warm even on frigid mornings. The Arc'teryx Patera Parka is celebrated for its warmth during snowstorms. However, it does come at a higher price point, so it's a significant investment piece.

More budget-friendly options, such as the Eddie Bauer Sun Valley Down Parka, may be ideal for milder climates.

For those preferring synthetic options, the Columbia Heavenly Hooded Jacket combines lightweight warmth with water resistance that's perfect for versatile weather conditions and enhanced mobility in mind.

More brands are also catering to diverse body shapes,





offering inclusive sizing from petite to plus. Adjustable waist drawcords and tailored cuts ensure a flattering fit without compromising functionality, letting wearers look great while staying comfortable. Users praise these jackets for their ability to withstand extreme conditions.

## AFFORDABLE AND FUNCTIONAL WOMEN'S JACKETS

A quality winter jacket doesn't have to break the bank. Many brands deliver affordable options that still offer impressive performance. For example, the REI Co-op Norseland Insulated Parka provides excellent warmth and durability for under \$250 and can be found on sale for under \$150. Similarly, the Marmot Strollbridge Jacket offers a sleek design and comfort at a reasonable price.

Look for jackets with water-resistant

coatings and easy-to-clean materials like polyester blends to ensure they last for multiple seasons. Removable faux fur trims and machine-washable options simplify care.

## WHERE TO FIND DEALS:

Shop during end-of-season sales or explore discount retailers like Backcountry Outlet and Sierra Trading Post for significant savings on premium brands. Loyalty programs at REI or Columbia can also help maximize discounts.

## TOP WINTER JACKETS FOR MEN: PERFORMANCE MEETS AESTHETICS

For men, the best winter jackets in 2025 offer a blend of rugged functionality and refined style.

Leading picks include The North Face McMurdo Parka, which is a consistent favorite, providing heavy-duty warmth with urban appeal. For those seeking lightweight options, the Patagonia Nano



Puff Jacket delivers excellent insulation in a packable design.

Consumer reviews highlight the durability of jackets like the Rab Neutrino Pro, which excels in extreme conditions. For milder climates, the Fjällräven Keb Eco-Shell stands out for its breathability and weatherproofing.

With options for tall, regular, and slim builds, brands ensure everyone can find a jacket that feels tailored to their body type. Features like adjustable cuffs and hem cinches enhance fit while preventing drafts.



## AFFORDABLE & FUNCTIONAL MEN'S JACKETS

Cost-conscious buyers can still find high-performing jackets that withstand the elements.

Options like the Columbia Whirlbird Interchange Jacket offer excellent versatility with its 3-in-1 system, while the REI Co-op Stormhenge 850 provides premium warmth at a mid-range price point.

The best winter jackets can still be an investment. So, it's important to prioritize jackets with reinforced stitching and durable materials like ripstop nylon to ensure they last for years. Water-repellent finishes add protection without requiring constant reapplication.

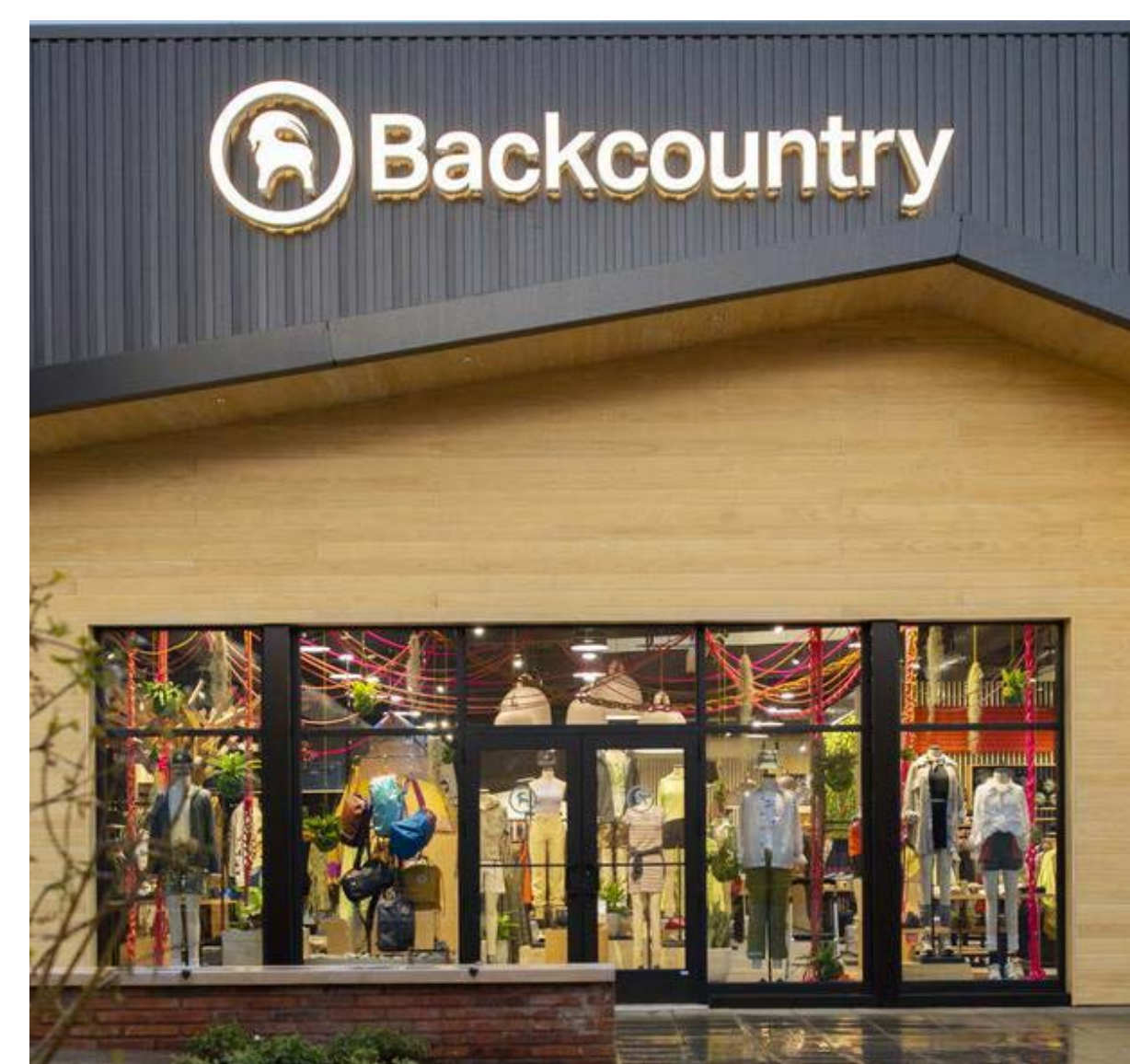
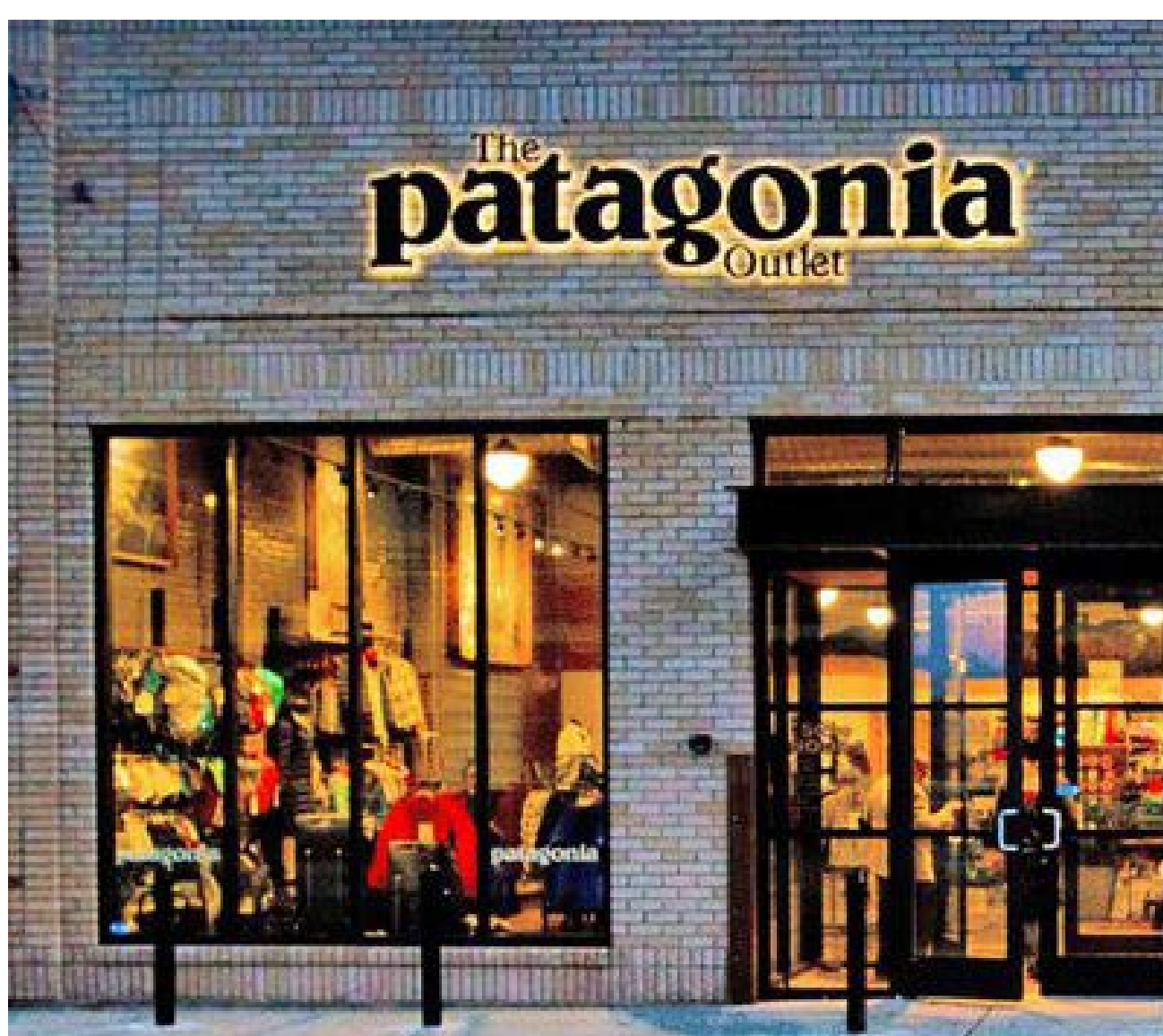



## WHERE TO FIND DEALS:

Outlet stores like Patagonia Worn Wear or The North Face Renewed offer refurbished or lightly used jackets at a fraction of the cost. Seasonal sales around holidays or during winter closeouts can also be good opportunities to score high-quality gear at a lower cost.

## FURTHER CONSIDERATIONS AND FINAL THOUGHTS

When choosing the best winter jackets of 2025 for RV adventures, exploring alternative options and staying informed about emerging trends can ensure you're prepared for the coldest conditions with the latest innovations.

Watch for the latest trends, such as heated jackets from brands like ORORO, which are gaining popularity for their built-in warmth with rechargeable battery packs. Sustainability continues to drive design, with brands like Patagonia and Fjällräven using recycled materials and eco-friendly treatments. Modular jackets, which allow you to swap layers for different climates, are also emerging as a practical choice for RVers navigating varied weather conditions.

In the future, we can expect further advances in insulation technology, like graphene-infused fabrics, for lightweight yet highly efficient warmth. Smart features, such

as integrated weather sensors and smartphone connectivity, may also start appearing in premium jackets, combining style with cutting-edge functionality.

**ADDITIONAL RESOURCES:** Websites like GearLab and OutdoorGearReview.com offer comprehensive side-by-side analyses of popular jackets. For RVers with specific needs, blogs and forums focused on outdoor and travel gear, like I Heart RVing, provide firsthand accounts of jacket performance in the field. In addition, you can find winter gear roundups from *Outside Magazine* and *Backpacker* to explore detailed reviews and expert recommendations.

Comparing offerings from brands like Patagonia, Columbia, Arc'teryx, and The North Face can highlight differences in warmth, fit, and price. Many retailers, including REI, also offer customer reviews and videos to help with decision-making.

In the end, the best winter jacket for 2025 for you is the one that meets your specific needs, from weather and activity level to personal style and budget. By staying informed and sharing insights with the RV community, you'll not only find the perfect jacket but also make your winter adventures even more enjoyable.

Happy travels! ❤️

CREATING LASTING MEMORIES

## Road-Worthy Games for the Whole Family



Road trips are about more than reaching your next destination as smoothly as possible. They are a chance to create lasting memories. Whether you're traveling with small children, teens, or other adults, the miles go by faster when you're engaged in the journey! To help you out, we've rounded up some of the best old-school car games to keep everyone entertained mile after mile.

### Going Old School

With the exception (in our opinion) of singing too many rounds of "99 Bottles of Beer on the Wall" to count (excuse the pun), sometimes the classics are unbeatable. They require nothing more than a little creativity, some patience, and a good sense of humor.

**I Spy:** A timeless favorite, this game is simple yet engaging. Players take turns describing an object they "spy with their little eye," giving hints for others to guess. It's perfect for getting people to look up and take in the beautiful scenery around them.

**20 Questions:** Test everyone's deductive reasoning and imagination. One person thinks of something, and the rest of the crew has 20 yes or no questions to figure out the answer. Expect a lot of laughter with unexpected

guesses, especially if you're traveling with little ones.

**License Plate Game:** Challenge players to spot license plates from as many states as possible. Bonus points for spotting rarer plates like Alaska or Hawaii!

**Alphabet Game:** And oldie but a goodie! This game has players race to find the entire alphabet on road signs, billboards, and bumper stickers. The fun can last for miles!

**I'm Going on a Picnic:** This is a memory game where players add to a growing list of items to take on a picnic in alphabetical order. It's trickier than it sounds and keeps everyone thinking.

These games are bound to keep boredom at bay and bring your family closer together on the open road.



6		8		7				
1			5			8	9	
		5	8		6			
	7			4		3		
8	2			6			1	7
		1		5			8	
			9		3	4		
	5	3			4			8
				8		6		9

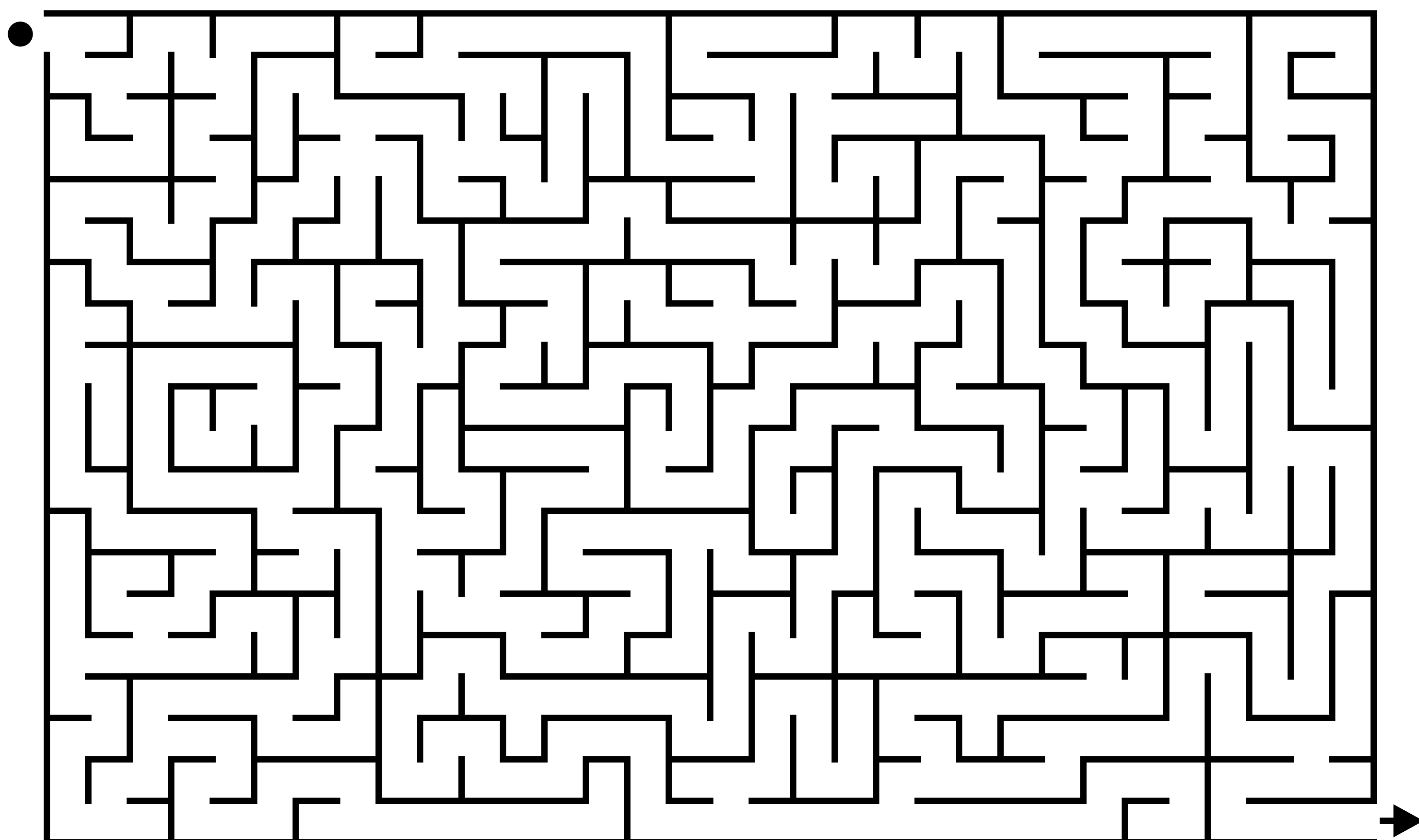



6	9	8	4	7	1	2	5	3
1	4	7	5	3	2	8	9	6
2	3	5	8	9	6	7	4	1
5	7	9	1	4	8	3	6	2
8	2	4	3	6	9	5	1	7
3	6	1	2	5	7	9	8	4
7	8	6	9	1	3	4	2	5
9	5	3	6	2	4	1	7	8
4	1	2	7	8	5	6	3	9

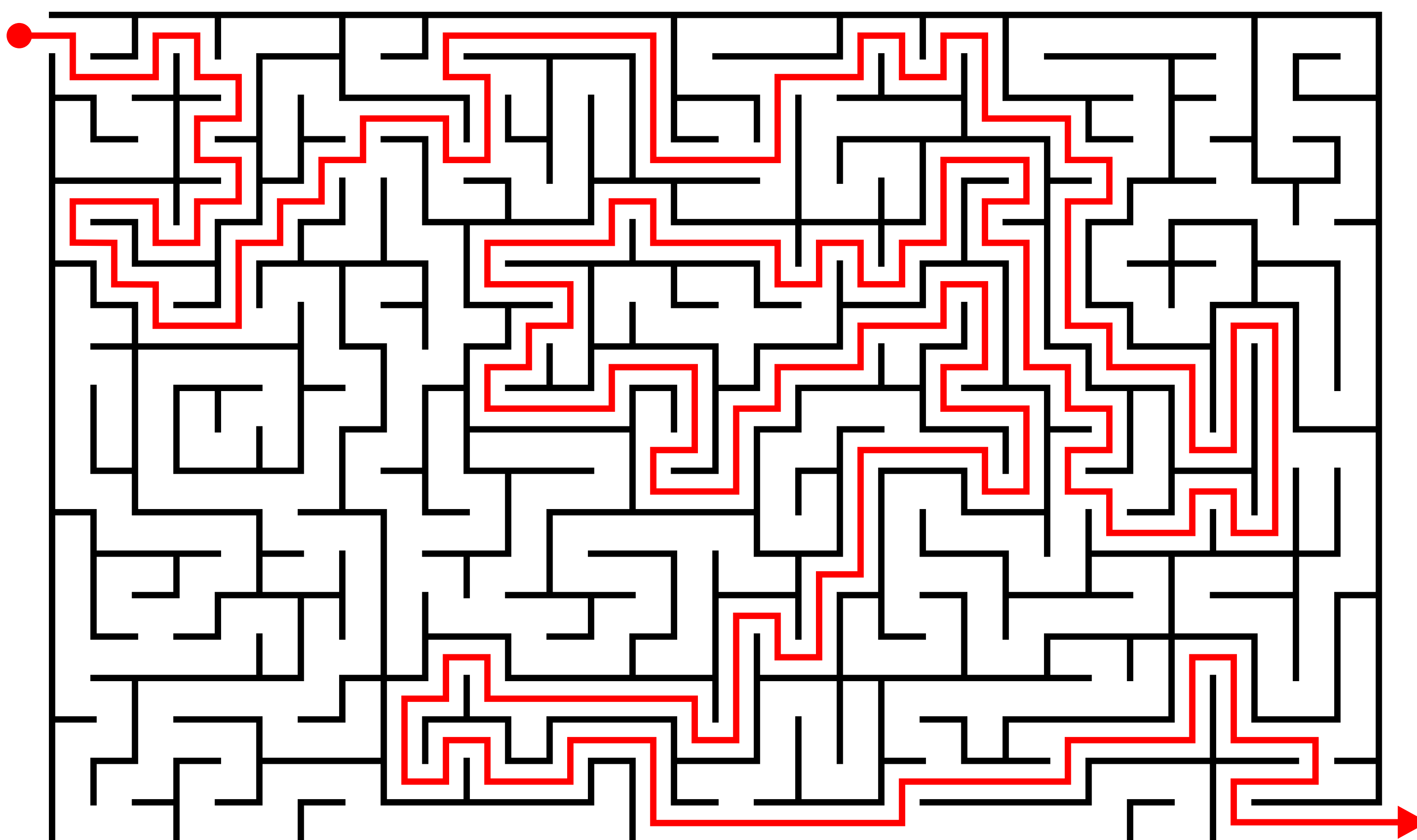



# Get 5G on the Road. Fast. Reliable. Secure.

Discover how AT&T enables our fast 5G speeds for customer to download, stream, and share when you're on the road.



---

## Northeast RV & Camping Show

*Dates: January 31 - February 2, 2025*

Location: Connecticut Convention Center, Hartford, CT  
[nervprod.wpengine.com/services/northeast-rv](http://nervprod.wpengine.com/services/northeast-rv)

---

## Fort Wayne RV & Camping Show

*Dates: January 30 - February 2, 2025*

Location: Allen County War Memorial Coliseum, Fort Wayne, IN  
[rvshows.org](http://rvshows.org)

---

## Oregon State – Salem Spring RV Show

*Dates: January 30 - February 2, 2025*

Location: Oregon State Fair & Expo Center, Salem, OR  
[salemspringrvshow.com](http://salemspringrvshow.com)

---

## Nebraska Boat, Sport, & Travel Show

*Dates: January 31 - February 2, 2025*

Location: Lancaster Event Center, Lincoln, NE  
[nebraskasportsshow.com](http://nebraskasportsshow.com)

---

## STL RV Travel Show

*Dates: January 31 - February 2, 2025*

Location: America's Center, St. Louis, MO  
[stlrv.com/rv-shows](http://stlrv.com/rv-shows)

---

## Southeast Texas Boat, Sport & RV Show

*Dates: January 31 - February 2, 2025*

Location: Ford Park, Beaumont, TX  
[setxboatrvshow.com](http://setxboatrvshow.com)

---

## KVAL Sportsmens and Outdoor Recreation Show

*Dates: January 31 - February 2, 2025*

Location: Lane Events Center, Eugene, OR  
[exposureshows.com](http://exposureshows.com)

---

## Alabama RV Show

*Dates: January 31 - February 2, 2025*

Location: Von Braun Center, Huntsville, AL  
[rvsupershows.com/shows/huntsville](http://rvsupershows.com/shows/huntsville)

---

## The Lawton RV and Boat Show

*Dates: January 31 - February 2, 2025*

Location: Comanche Country Fairgrounds, Lawton, OK  
[lawtonrvandboatshow.com](http://lawtonrvandboatshow.com)

---

## Iowa RV Show

*Dates: February 1 - 4, 2025*

Location: Iowa State Fair Grounds, Des Moines, IA  
[iarvshow.com](http://iarvshow.com)

---

## Jacksonville RV Mega Show

*Dates: February 6 - 9, 2025*

Location: Jacksonville Equestrian Center, Jacksonville, FL  
[frvta.org](http://frvta.org)

---

## St. Cloud Sportsmen's Show

*Dates: February 7 - 9, 2025*

Location: River's Edge Convention Center, St. Cloud, MN  
[stcloudsportshow.com](http://stcloudsportshow.com)

---

## Seven Feathers Sportsmen's & Outdoor Recreation Show

*Dates: February 7 - 9, 2025*

Location: Douglas County Fairgrounds, Roseburg, OR

[exposureshows.com](https://exposureshows.com)

---

## La Crosse Sports Show

*Dates: February 6 - 9, 2025*

Location: The La Crosse Center, La Crosse, WI

[lacrossesportshow.com](https://lacrossesportshow.com)

---

## The Exclusive West Virginia RV Show

*Dates: February 7 - 9, 2025*

Location: Hazel & J.W. Ruby Community Center, Morgantown, WV

[hexclusivewvrshow.com](https://hexclusivewvrshow.com)

---

## Charleston RV Show

*Dates: February 9 - 11, 2025*

Location: North Charleston Convention Center, Charleston, SC

[rvsupershows.com/event-details-registration/charleston-rv-show](https://rvsupershows.com/event-details-registration/charleston-rv-show)

---

## Houston RV Show

*Dates: February 12 - 16, 2025*

Location: NRG Center, Houston, TX

[houstonrvshow.com](https://houstonrvshow.com)

---

## Chicago RV & Camping Show

*Dates: February 13 - 16, 2025*

Location: Donald E. Stephens Convention Center, Rosemont, IL

[chicagorvshow.com](https://chicagorvshow.com)

---

## Duluth Boat, Sports Travel & RV Show

*Dates: February 13 - 16, 2025*

Location: Duluth Entertainment Convention Center, Duluth, MN

[minnesotasportshow.com](https://minnesotasportshow.com)

---

## 60th Utah's Sportsman, Vacation & RV Show

*Dates: February 13 - 16, 2025*

Location: Mountain America Expo Center, Sandy, UT

[utahrvshow.com](https://utahrvshow.com)

---

## Minneapolis/St. Paul RV Vacation & Camping Show

*Dates: February 13 - 16, 2025*

Location: Minneapolis Convention Center, Minneapolis, MN

[shows.campingworld.com/ultimate-rv-show-minneapolis-minnesota](https://shows.campingworld.com/ultimate-rv-show-minneapolis-minnesota)

---

## Austin RV Expo

*Dates: February 13 - 16, 2025*

Location: Austin Convention Center, Austin, TX

[austinrvexpo.com](https://austinrvexpo.com)

---

## Erie RV & Outdoor Adventure Expo

*Dates: February 14 - 16, 2025*

Location: Bayfront Convention Center, Erie, PA

[eriepromotions.com/erie-rv](https://eriepromotions.com/erie-rv)

---

## Birmingham RV Super Show

*Dates: February 14 - 16, 2025*

Location: BJCC, Birmingham, AL

[rvsupershows.com/shows/birmingham](https://rvsupershows.com/shows/birmingham)

---

## Cedar Rapids Sportshow

*Dates: February 14 - 16, 2025*

Location: Hawkey Downs Expo Center, Cedar Rapids, IA  
[boatrvandsportshows.com/event/cedar-rapids-boat-rv-vacation-show](https://boatrvandsportshows.com/event/cedar-rapids-boat-rv-vacation-show)

---

## Springfield RV Camping & Outdoor Show

*Dates: February 14 - 17, 2025*

Location: Eastern States Exposition, West Springfield, MA  
[springfieldrvcampingshow.com](https://springfieldrvcampingshow.com)

---

## 70th Annual Ford Indianapolis Boat, Sport & Travel Show

*Dates: February 14 - 16 and 19 - 23, 2025*

Location: Indiana State Fairgrounds, Indianapolis, IN  
[indysportshow.com](https://indysportshow.com)

---

## Maryland RV Show

*Dates: February 14 - 17 and 21 - 23, 2025*

Location: Timonium, MD  
[mdrv.com/RV-show-RVs-dealer-Maryland-MD-trailer-camper-motorhome.php](https://mdrv.com/RV-show-RVs-dealer-Maryland-MD-trailer-camper-motorhome.php)

---

## The 50th Annual Northeast RV Show

*Dates: February 14 - 17, 2025*

Location: Rockland Community College Fieldhouse, Suffern, NY  
[gleshows.com](https://gleshows.com)

---

## Michiana Camping & RV Show

*Dates: February 20 - 22, 2025*

Location: Michiana Event Center, Shipshewana, IN  
[michianaevents.com/event/camping-show](https://michianaevents.com/event/camping-show)

---

## West Palm Beach RV Show

*Dates: February 20 - 23, 2025*

Location: South Florida Fairgrounds, West Palm Beach, FL  
[frvta.org](https://frvta.org)

---

## Dallas RV SuperSale

*Dates: February 20 - 23, 2025*

Location: Dallas Market Hall, Dallas, TX  
[dallasrvsupersale.com](https://dallasrvsupersale.com)

---

## Arkansas RV Show

*Dates: February 21 - 23, 2025*

Location: Statehouse Convention Center, Little Rock, AR

[dgattractions.com](https://dgattractions.com)

---

## Wisconsin RV & Boat Main Sales Event

*Dates: February 21 - 23, 2025*

Location: EAA Grounds, Oshkosh, WI  
[rvboatmainevent.com](https://rvboatmainevent.com)

---

## Virginia RV Expo

*Dates: February 21 - 23, 2025*

Location: Hampton Roads Convention Center, Hampton, VA  
[varvexpo.com](https://varvexpo.com)

---

## QCCA/RV & Camping Show

*Dates: February 21 - 23, 2025*

Location: QCCA Expo Center, Rock Island, IL  
[qccaexpo.com/rvcampingshow](https://qccaexpo.com/rvcampingshow)

---

## Pennsylvania Adventure RV Expo

*Dates: February 21 - 23, 2025*

Location: Blair County Convention Center, Altoona, PA  
[parvexpo.com](https://parvexpo.com)

---

## Milwaukee RV Show

*Dates: February 27 - March 2, 2025*

Location: State Fair Park  
Wisconsin Exposition Center,  
West Allis, WI

[milwaukeeervshow.com](http://milwaukeeervshow.com)

---

## Annual CNY RV & Camping Show

*Dates: February 27 - March 2, 2025*

Location: NYS Fairgrounds,  
Syracuse, NY

[cnyrvshow.com](http://cnyrvshow.com)

---

## Hot Springs Boat, Tackle, & RV Show

*Dates: February 28 - March 2, 2025*

Location: Hot Springs  
Convention Center, Hot  
Springs, AR

[dgattractions.com](http://dgattractions.com)

---

## Crown Motors NorCal Boat, Sport & RV Show

*Dates: February 28 - March 2, 2025*

Location: Shasta District Fair  
& Event Center, Anderson, CA

[exposureshows.com/2025-shows/norcal.html](http://exposureshows.com/2025-shows/norcal.html)

---

## Battle Creek RV & Camping Show

*Dates: February 28 - March 2, 2025*

Location: Kellogg Arena,  
Battle Creek, MI

[michiganrvandcampgrounds.org](http://michiganrvandcampgrounds.org)

---

## Springfield RV Mega Show

*Dates: February 28 - March 2, 2025*

Location: Ozark Empire  
Fairgrounds, Springfield, MO

[springfieldrvmegashow.com](http://springfieldrvmegashow.com)

---

## Oregon State Eugene Spring RV Show

*Dates: February 28 - March 2, 2025*

Location: Lane County  
Fairgrounds, Eugene, OR

[eugenefairgrounds.com](http://eugenefairgrounds.com)

---

## Greater Philadelphia RV Show

*Dates: February 29 - March 3, 2025*

Location: Greater Philadelphia  
Expo Center, Oaks, PA

[phillyrvshow.com](http://phillyrvshow.com)

---

## MHRV Seattle RV Show

*Dates: March 6 - 9, 2025*

Location: Lumen Field  
Events Center, Seattle, WA

[seattlervshow.com](http://seattlervshow.com)

---

## 60th Annual 2025 Red River Valley Sportsmen's Show

*Dates: March 6 - 9, 2025*

Location: Fargodome, Fargo,  
ND

[argosportshow.com](http://argosportshow.com)

---

## Ocala RV Show

*Dates: March 6 - 9, 2025*

Location: Florida Horse Park,  
Ocala, FL

[frvta.org/show/ocala-rv-show](http://frvta.org/show/ocala-rv-show)

---

## The Great Alaska Sportsman Show

*Dates: March 7 - 9, 2025*

Location: Dena'ina Civic  
and Convention Center,  
Anchorage, AK

[greatalaskasportsmanshow.com](http://greatalaskasportsmanshow.com)

---

## Denver Travel Show

*Dates: March 8 - 9, 2025*

Location: Colorado  
Convention Center, Denver,  
CO

[travelshows.com/shows/  
denver](https://travelshows.com/shows/denver)

---

## FMCA's International Convention & RV Expo

*Dates: March 12 - 15, 2025*

Location: Georgia National  
Fairgrounds & Agricenter,  
Perry, GA

[fmca.com/fmca-event-  
registration](https://fmca.com/fmca-event-registration)

---

## Eastern Iowa Sportshow

*Dates: March 14 - 16, 2025*

Location: Uni-Dome, Cedar  
Falls, IA

[boatrvandsportshows.  
com/event/eastern-iowa-  
sportshow](https://boatrvandsportshows.com/event/eastern-iowa-sportshow)

---

## Bismarck Rec & Leisure Show

*Dates: March 14 - 16, 2025*

Location: Bismarck Event  
Center, Bismarck, ND

[t2promotions.com/bismarck-  
rec-leisure](https://t2promotions.com/bismarck-rec-leisure)

---

## 48th Annual Flint RV & Camping Show

*Dates: March 14 - 16, 2025*

Location: Flint, Michigan  
[michiganrvandcampgrounds.  
org/rv-shows](https://michiganrvandcampgrounds.org/rv-shows)

---

## Sioux Empire Sportsmen's Show

*Dates: March 13 - 16, 2025*

Location: Sioux Falls Arena,  
Sioux Falls, SD

[siouxfallssportshow.com](https://siouxfallssportshow.com)

---

## Northwest Sportshow

*Dates: March 13 - 16, 2025*

Location: Minneapolis  
Convention Center,  
Minneapolis, MN

[northwestsportshow.com](https://northwestsportshow.com)

---

## Mid-Atlantic RV Expo

*Dates: March 14 - 16, 2025*

Location: Meadow Event  
Park, Doswell, VA

[midatlanticrvexpo.com](https://midatlanticrvexpo.com)

---

## New Hampshire Camping & RV Show

*Dates: March 14 - 16, 2025*

Location: The Hampshire  
Dome, Milford, NH

[nhlovescampers.com/  
nh-camping-rv-show](https://nhlovescampers.com/nh-camping-rv-show)

---

## York RV Show

*Dates: March 21 - 23, 2025*

Location: York, PA

[yorkrvshow.net](https://yorkrvshow.net)