

CLAIM THE PERFECT PARKING SPOT TO SEE FIREWORKS

PLUNGE INTO FRESHWATER FUN FOR THE WHOLE FAM

REIMAGINE TRUCK CAMPING IN THE KINGSTAR CAMINO 88

I ♥ RVing



DECLARE AN ALL-AMERICAN SUMMER

7 WAYS TO RV AMERICA FROM PURPLE MOUNTAINS TO SHINING SEAS ▶ p. 60

+Plus

5 Outdoor RV Kitchens We Love—and What to Throw on the Grill



Summer 2023

@IHEARTRVING  
IHEARTRVING.COM

\$7.99

33>





DISCONNECT TO RECONNECT.

Formed out of a desire to build a better RV by building a better RV company, Ember set out to blaze an uncharted path by crafting innovative products backed by an industry-leading warranty, giving every adventure-seeking, memory-chasing owner the confidence to enjoy every mile.

For more information, visit EmberRV.com



Overland Series

Touring Edition



75+

awesome RV stories
dropping each year.

Subscribe to
catch them all!



Get 15% OFF & 1 FREE issue with code SPECIAL15.

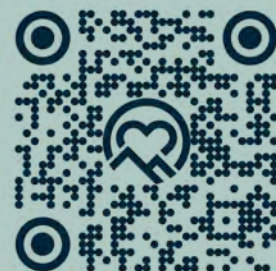

Scan the QR code or visit
IHeartRVing.com/Subscribe





Protect your suite way to travel

Get coverage from a leader in RV insurance.

1-800-PROGRESSIVE / PROGRESSIVE.COM

PROGRESSIVE

Quote in
as little as
4 minutes



Progressive Casualty Insurance Co. & affiliates.



25

5 Scintillating Outdoor Kitchens

No one loves a beautiful galley like us, but we can do without the heat of cooking inside. We'd rather take all the sizzle outside, and we're ready to show the five outdoor RV kitchens that we think do it best. See what makes them special.

52

Savannah Cools the Blue Blazes

Savannah, Georgia—like U.S. history—is a kaleidoscope of bizarre contradictions. Gators on golf courses. Cocktails in a prohibition museum. Step inside the stylish resort that plays the perfect Southern host.

By Mark Settle

60

7 All-American Road Trips

There are no flyover states when you're RVing, but we've selected the most family-friendly, America-loving road trips. Drive them and give your family a fuller picture of the glory, glory, hallelujah that makes America great.

By Marc Acton

71

Pioneers Leading New Way to RV

Toughness, self-sufficiency, and individuality. The American Coach Patriot and KingStar Camino 88 have those rock-hard qualities in spades. But both are also forging new paths—like good Americans—in innovation and luxury.

Departments

7 FREE TO GO

8 MIRROR CHECK

A Brief Look at the RV News and Community
Catch up on RV news and highlights, listen to freedom ring on Spotify, and preview Brian W. Conway's debut campground crime thriller.

15 AMERICAN VISTA

Vantage Points of American Beauty
Take the high road into the Rockies to get the nation's absolute best view of those fruited plains.

25 ROAD ABODE

Improving Life on the Go

- 26 5 Sizzling Outdoor Kitchens
- 32 Low-Cost, High Impact Upgrades
- 35 Grilling That Taste of America

39 EDGE OF THE MAP

From the Highway to the Campground

- 40 Riding Toward Mount Rushmore
- 43 Safety Essentials for Family Travel
- 49 4 Great Firework Displays
- 50 RV Park Roster for Fall Football
- 52 Savannah's Curious Campground

59 RVX

Camping, Adventure, and the RV Experience

- 60 7 All-American Road Trips
- 67 Thar She Blows!
- 68 Paddle That Summer Heat

71 TOP LEVEL

RV Tech and Tradecraft

- 72 The American Coach Patriot
- 74 KingStar's Reimagined Truck Camper
- 76 RELION Outlaw 1072s Review

77 FIRESIDES

Final Toasts and Last Roasts for the Road

- 77 One Last Celebration
- 78 Puzzles

SUMMER 2023



Campground Finder

- 49 Cherry Hill Park, College Park, MD
- Village Scene RV Park, Harfield, PA
- Rip Van Winkle Campgrounds, Saugerties, NY
- Normandy Farms Family Camping Resort, Foxboro, MA

- 50 South Prairie Creek RV Park, South Prairie, WA
- Clear Creek RV Park, Golden, CO
- Walnut Hills Family Campground, Durand, MI
- Campground Margaritaville RV Resort, Pigeon Forge, TN
- 52 CreekFire RV Resort, Savannah, GA

I♥RVing

I HEART RVING
magazine publisher | **Marc Acton**
managing editor | **Mark Settle**
design director | **Brian Harvat**

sales & partnerships director | **Kim Whitaker**
(kim@iheartrving.com)
integrated media sales | **Laurie Zak**
(laurie@iheartrving.com)
Please contact us to advertise with I Heart RVing

content contributors | **Liran Federmann, Sue Mosebar**
product manager | **Brent Noble**
video & social producer | **Nate Kennedy**
social promoter | **Craig Mitchell**
email manager | **Jessica Jiron**
digital marketing specialist | **Larry Norris**
digital media specialist | **Emily Leavens**
developers | **Jason Shores, Ralph Aroloj**
fp & a | **Callip Hall**
intern | **Lilly Petsolt**

I HEART RVING LLC
cofounder | **David Petsolt**
cofounder | **Adam Acosta**

**THANK YOU FOR JOINING US AT THE
I HEART RVING GLOBAL CAMPGROUND.
PACK IT IN, PACK IT OUT
EXTINGUISH ALL FIRES
SORRY FOR WHAT I SAID WHEN I
WAS TRYING TO PARK THE RV
PLEASE RECYCLE THIS MAGAZINE
(OR, PREFERABLY, GIVE IT TO A FRIEND!)**



FINE PRINT/DISCLAIMERS

Copyright © 2023 by I Heart RVing, LLC
Published by I Heart RVing, LLC. I Heart RVing Magazine was founded in 2021 by a crazy bunch of dreamers, story makers, and idea tree shakers who just want to watch the world read.

I Heart RVing makes every effort to provide information that is informative and practical. The publisher, editor, and writers are not responsible for any adverse outcomes or consequences resulting from the use of suggestions or products that appear in this magazine. The acceptance of advertising in this publication does not constitute or imply endorsement by I Heart RVing, LLC (including parent companies, contributors, affiliates or partners) of any advertised product or service. I Heart RVing accepts no responsibility for claims made in advertisements in this publication.

For all subscription updates and inquiries, go to IHeartRVing.com and submit a Contact form with your details. To subscribe to the magazine, visit IHeartRVing.com/subscribe. To submit a story idea, please contact editorial@IHeartRVing.com.

The Greatest American Hobby



Our I Heart team has always thought of RVing as a quintessential American pastime, but no one has summed up why more succinctly than Jamie Goncharoff in this issue's feature on American road trips (Page 60). "With RVing," he says, "it's having the freedom to move, stop, live, sleep, and eat—on your timetable. You're not checking into a motel at three in the afternoon and sleeping in somebody else's bed, and getting kicked out at twelve o'clock. You have the freedom to go, to experience things, and to meet people."

Those three verbs hit the American nail on the head for me. Go. Experience. Meet. There's value in each, but together they give an insight into what makes RVing the Great American Hobby.

First, to go. Too often these days we find ourselves stagnant, don't we? As we face a new job, a new relationship, or a move to a new town—even as we know there are greener pastures available—our inertia tends to keep us at rest. But it's more American of us to go. To explore—west, north, higher, deeper. And as we often say, it's impossible to go without changing, stretching, and learning in life-changing ways.

Even then, we also have to choose to experience. Trying new foods, new music, new friends, or even imagining that there are new ways to view your world—these all take guts. But what's more American than embracing the new? Americans are born boundary pushers. And so are RVers.

And then there's meeting people. Mark Twain said, "Travel is fatal to prejudice, bigotry, and narrow-mindedness." The RV park, like most of life, is best when shared. And the value of travel is at its highest when we follow the American value of accepting people and our differences. It's right there in the Declaration of Independence that all men are created equal.

Jamie Goncharoff took his kids to each of the Lower 48 states. On those journeys, they found the freedom that comes from RV-based independence. But toward the end of his story, you'll see how other American ideals rubbed off on the character of his kids.

This is why we love the RV, not just because it takes us to great places, but because if you have the guts to go, embrace new experiences, and meet people along the way, you'll arrive at a place with less prejudice, less bigotry, and a broader view of life—everything that makes America what it is and what it should be.

Love ya, mean it.

Marc.

Marc Acton
Publisher



IN THE NEWS

Airstream and Porsche Explore Garageability

Few brands are more iconic than Airstream and Porsche. In fact, each is so well-defined that one instantly wonders what could motivate such a historic collaboration. No surprise to anyone, the creative partnership with Studio F.A. Porsche has a big task: reshaping the future of RVing.

Airstream's President & CEO, Bob Wheeler, says, "When we first envisioned this collaboration, there were several things that we wanted to try to accomplish that we weren't sure we could without some outside thinking. We wanted a travel trailer that was sleek, easy to tow, low-profile, garageable." Part of the concept was creating a trailer that electric

vehicles could tow.

Even the innovators at Porsche were awed by the challenge. Steffen Ganz, head of design at Porsche Design of America, admits, "Putting your hands on something that is ... essentially a perfect product already. That's quite a challenge to come up with an idea that improves this." But come up with ideas they did.

At home, the trailer's chassis can be lowered to crouch in a garage; but out in the wild a roof section can be raised to increase standing space. Garageability alone could open up an entirely new market for urban buyers—and that's but a fraction of the ingenuity involved.



Take a tour of this concept's most innovative features.

SUMMER'S POPULAR TRAVEL TREND

▶ It's a trend that only travels in one direction: Every year more Americans go on RV trips. According to RVIA and Cairn Consulting, 67 million Americans plan to RV in 2023. (Up two mil from 2022.) What's more? Almost half of Gen Zers (49 percent) and Millennials (48 percent) plan to be in that group.

67M AMERICANS PLAN ON AN RV TRIP IN 2023

HALF OF GEN ZERS PLAN TO RV THIS YEAR

California Aims to Ease Reservation Frustration

California state parks attract more than 6.5 million visitors a year, according to the office of Democratic Assemblymember Rebecca Bauer-Kahan. But, as a recent Dyrtr poll noted, many visitors are unhappy with the registration process. According to RVTravel.com, a new state bill (AB 618) has been proposed that adds incentives and penalties to the cancellation policy, with the intent to improve visitor accountability and campsite availability.

Learn more about the bill at LegInfo.Legislature.ca.gov.



Sunglasses Throw Shade on National Parks

It doesn't take long to figure out: goodr—a sunglasses company with a flamingo as their CEO (his name is Carl)—likes to have fun. Famous for their stylish, low-cost "sunnies" (aka sunglasses that don't bounce when you run), goodr is now celebrating select national parks with custom shades.

Rock a pair of stylish sunnies from goodr.com at your favorite national park.

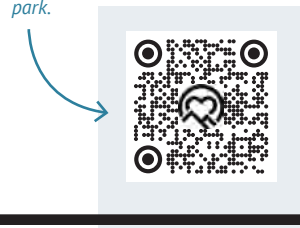

Photo courtesy of Airstream

East to West Makes a Big All-Weather Debut

For countless RVers, camping season has a well-defined boundary: When it's too cold in the cabin, it's time to put it in park. But East to West is looking to change all that and extend the camping season with the brand-new ALTA Xtreme 365. It's one of the rare 35-foot travel trailers specifically constructed—and insulated—to do so, with: a 5-inch vacuum bonded crowned roof; 3-inch laminated sidewalls (Azdel inside and out); dual-pane windows; triple-insulated floors; tank heaters; a forced air and heated underbelly; and a 40,000 BTU furnace (plus an electric fireplace).

See all its Xtreme features for all-weather camping at EastToWestRV.com.

Two Peas in an RV Podcast for Newbies

Angie Morell and Chuck Lasley have seen the RV industry swell over the last four years. That means there are a lot of newbies on the road. So, the two execs from the National Indoor RV Centers have launched a brand-new RV podcast, "RV360," that will provide fun and helpful tips for RV owners of any experience level. Thirty-minute episodes will air weekly.



Listen in and follow RV360 on Spotify and Apple Podcasts.



Shark Tank Bites Into Truck Camping

Last March, ABC's Emmy Award-winning show "Shark Tank" took a big bite into the truck camping business. In episode 1419, three of FLATED's four founders presented the world's first inflatable truck topper, the Air-Topper, which enables customers to quickly convert their truck into a truck camper. Simple, light, strong, and storable—the product drew the attention of one shark in particular who was hungry for a deal.

Watch to find out which shark took a bite into the camper industry. (And take a bite of your own at GetFLATED.com.)



Lost Signal: Inside the Nomad Internet Scandal

Nomad Internet made some big claims and big promises to their RV customers—and to the RV influencers who endorsed them. But was that trust compromised? Next issue, we'll take a closer look at the controversy and fallout from this alleged scandal.

Look for our upcoming feature next Fall.

Let Freedom Ring

PLAYING YOUR FAVORITE SONGS ABOUT THE LAND YOU LOVE.

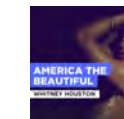

Whitney Houston, "America the Beautiful"

No one sings this—or the national anthem—like Whitney. (Which is why both are on our playlist.) Quite simply, there's no better song to kick off a road trip into the spectacle of America's natural beauty.

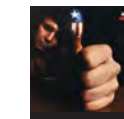

Don McLean, "American Pie"

This Billboard-busting ballad from the '70s paints America as a land of social change, big dreams, major letdowns, but above all, great music. Safe to say, Don got it right.



Lee Greenwood, "God Bless the U.S.A."

Look: We'll give you 43 seconds to resist singing this heart-swelling classic out loud. But once that chorus kicks in, your singing will shift to automatic. (Extra patriot points if you cry, but no need to stand while driving.)



Cynthia Erivo, "Stand Up"

We love this modern take on African-American spirituals from the Harriet motion picture soundtrack. And we're not gonna lie: The lyrics go perfect with an RV road trip.



Lynard Skynard, "Free Bird"

Not really sure this pick requires any explanation. Just hit play and fly high down the highway, free bird. There're too many places you gotta see.

ENJOY THE SWEET SOUND OF LIBERTY

Give your drive a star-spangled soundtrack. Click the ♥ on our America the Beautiful playlist on Spotify—then lift every voice and sing.

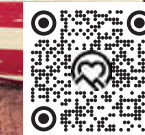
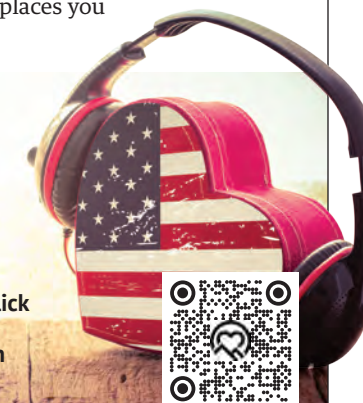

One Red-Hot Handle

TALKING WITH THE CAMPERS WE LOVE AND FOLLOW ON SOCIAL MEDIA



➔ The journey of 1,000 miles may begin with one step, but an epic RV journey of 10,000 miles? That begins with a big decision. But for one adventurous, multinational family, there's never been a better time than this Summer to say goodbye to the old routine and hello to the open road. After running a busy RV rental business for five years, they've decided that it's their turn for adventure. Heck, they even have nicknames picked out.



Who's on board? "The Bossman," Captain of the RV and a predictably punctual German. Then there's his Irish copilot, "The Wife," and their American daughter, "The Testy Teen." (And we haven't even mentioned the aunts—or cats.) See what "The Wife" has to say about their once-in-a-lifetime trip to see America the Beautiful together.



Follow every epic mile at TheEpicRVRoadTrip.com and on Facebook, Instagram (@theepicrvroadtrip), and Twitter.

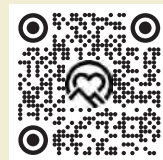

Why the Epic Time Is Now

My husband, "The Bossman," has been chained to an office desk for over 30 years and is set to start his new job mid-August. So, now he is free to explore and fulfill his dream of a long road trip. As a high school teacher, I'm always willing to hit the road and find new places in the Summer. Our London-based sisters, "The Wanderly Wagons," are also finishing off sabbatical

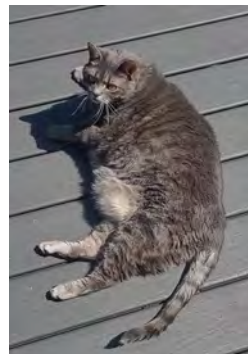
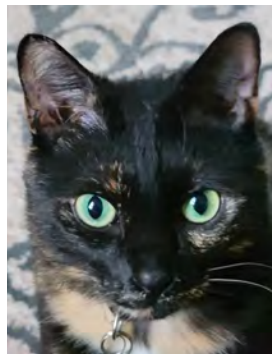

years from business and spending the Summer as our tag-a-longs. Our daughter, "The Testy Teen," will get her driver's license in August. (Once she can drive, we will have to book an appointment to see her!)

A Journey of 10,000 Miles

After 10 years of RVing, we are ready to take Remi, our 36-foot Thor Motor Coach Hurricane 35M, on "The Epic RV Road Trip" of almost 10,000 miles. The journey just started June 4 outside of Philadelphia, and it goes down the East Coast to St. Augustine, over to New Orleans, up through Texas and New Mexico to Colorado. From there, we head into Utah, Oregon, Washington State and Montana. The highlight of our trip will be Yellowstone National Park, Mount Rushmore, and the Badlands. There is so much to see in America. We can't wait. It is going to be EPIC.

The Testy Teen's Take

Is she excited about the Epic Trip? The trip of a lifetime? The chance to see the beautiful U.S. of A. Well, not quite. Here's her take: You are kidding me, right? Two months cramped in with four adults (one that's vegan), one teen, and two cats in one RV. I'd rather die. (Her aunts initially were supposed to house-sit with her, but once they saw the itinerary, they blagged their way onto the entire trip.) So, it might be a miracle if we all make it back alive. The question is: Who will get thrown out of the RV first? Join us to find out.

Photos courtesy @theepicroadtrip

Photos Instagram: @rvlovetravel/@lessjunkmorejourney/@vintageclampers/@revampingcamping

@RVLOVETRAVEL

WHY WE HEART IT

Marc and Julie do it all: have fun and go viral! No surprise to anyone, they've hit all 50 states ... and made the rest of us jealous.



Scrolling the Virtual Campground

@LESSJUNKMOREJOURNEY

WHY WE HEART IT

Because nothing is more I Heart-warming than sharing adventures and making memories with your kids. Nathan and Marissa live that American dream.



@REVAMPINGCAMPING

WHY WE HEART IT

Everyone knows we love outdoor RV kitchens (see Page 26). But only indoor galley—beautifully crafted by David and Carrie—can look like this.



@VINTAGEGLAMPERS

WHY WE HEART IT

Beth, Eric, and little Lola are living that #VintageLife. Their Scotty Camper is a cozy classic for three free spirits on the move.

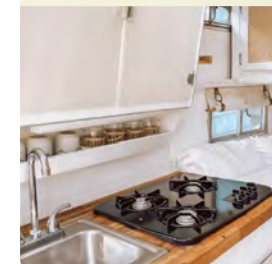

Most Played TikTok

@CAPTAINRV_

Oh, PLEASE don't let this be you! (See Page 43 for some safety pointers.)



"Be aware of this issue if you own an RV #RV #Trailer #camper #accident #safety #offroad #ecocamper #fyp"



Share Some Laughs and Likes

Join us on social as we share everything RV—including giveaway offers with great brands. We'll save you a spot at @IHeartRVing on Facebook and @IHeartRVing over on Instagram.

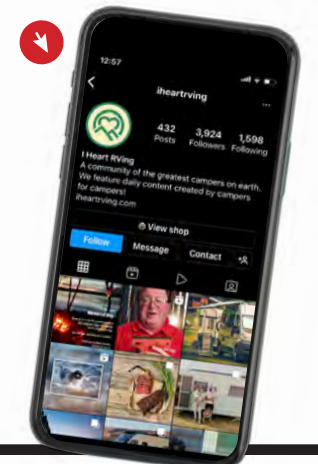

One Bad Campground

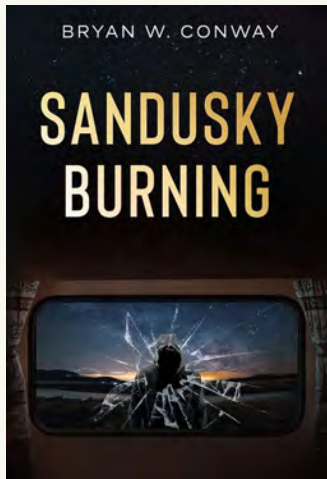

BRIAN CONWAY'S CRIME THRILLER IS A SLOW-BURNING DEBUT DE FORCE THAT'S PARKED ON THE ROCKS.

MOST CAMPERS KNOW what a rough week looks like. But Brady Sullivan, the protagonist at the center of *Sandusky Burning*, takes a rough week to a whole new level. What level is that exactly? The drugged-then-blackmailed-for-access-to-his-security-clearance level. This is Bryan W. Conway's first novel, and it opens with

the hair-raising scene of an RV screeching sidelong behind a train it's chained to. If you're left wondering what happened, you're meant to. Conway's narrative then takes you one week back, passing the baton in first-person narratives that keep the story moving and the characters (there are many) in context. Some novels, like Erin Gordon's *Peeps*, use the RV as a vehicle for their story. *Sandusky Burning* is another matter. The campground itself is the central setting of the novel, and Conway clearly knows his way around—inside the RV and out—keeping you hopping from campsite to campsite with the action. (Like any campground, it would be convenient if there was a map.) Sandusky is an unfortunate name for a town (a real one), and in this work of fiction, it lives up to its horrific name. Beneath its unassuming surface as an overnight tourist-trap for a local theme park, the campground is a din of criminal activity—where trafficking and extortion are the real business. The novel's most convincing characters are employees (in one fashion or another) of the local crime lord, Randy, who owns the campground and operates out of an uparmored and bulletproofed trailer on site. Readers quickly meet the skeezy Chuck, petty and possessive of his golf cart, gulling guests into sharing too much information over beers. Then there's the brutal Sam, whose thuggish, sneering menace shadows every page he's on.

When Brady Sullivan, an estranged husband reluctantly summering in his RV, lets it slip that his work requires a security clearance, it doesn't take long for the bad guys to pounce. Fortunately, a fellow camper and Army veteran, Mike, has Brady's back; unfortunately, neither Brady nor Mike has any idea how much black water they're in.

It's helpful for a reader to know that while the book is a thriller, it takes its time ramping up. Even so, when it does ramp up, the action rolls like movie scenes from "Taken"—night raids from lake yachts, druggings, poisonings, interrogations, shootouts, and a dramatic return to the first scene with the train.

As a first novel, there's some expected room for polish. An unusual amount of time is spent detailing the drinking habits of all-too-many characters—decisions whether to drink or not (almost always to drink) and then followed by rather elongated descriptions of each hangover. Unavoidably, you're left with the impression that the novel's length could be neatly reduced and the pace greatly enhanced if these descriptions were spaced out with more ... moderation. Likewise, other descriptions—geography and apparel choices—can get a little superfluous, placed as they are in first-person narratives. Often, descriptions seem to help set the scene for the reader, even when they're unimportant to the speaker in the narrative. None of this, however, totally derails the novel off its train-bound course. Like its beginning, the end of *Sandusky Burning* is abrupt—clearly a climatic finish intended to drive us to Conway's next novel, *Sandusky Reckoning*, where the story continues. The finish is full of surprises, but perhaps none is more arresting than the final chapter, where Conway gently shepherds a character off-stage. The achingly tragic exit leaves the reader with a clear suspicion—that Conway's pen has an even greater range than his current odometer shows.

Editor's Note: *Sandusky Burning* contains adult language, substance use, and sexual content that is unsuitable for young readers.



LESS-LETHAL SELF-DEFENSE



STARTING AT

\$299.99

- NOT CLASSIFIED AS A FIREARM
- NO BACKGROUND CHECKS
- NO PERMITS REQUIRED
- OVER 7,000 4.5 STAR REVIEWS

 **BYRNA.COM/RV**

**Don't let
a bug bite
keep you up
all night!**



Easy,
one-touch
application!

- Instant Relief
- Stops Itching On Contact
- Stops Pain Fast
- Relieves Swelling

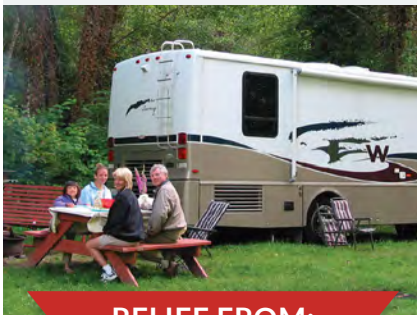

RELIEF FROM:

- Fire Ants
- Fleas
- Chiggers
- Mosquitoes
- Ticks
- Bees
- Sand Flies
- Wasps

Get relief from bug bite pain and itch with ChigaRid!

ChigaRid.com | 214-951-8687



MIRROR CHECK

RV QUIZ

Put Your Patriotism to the Test!

Can you tell what's red, white, and true—or false?

No. 1

"America the Beautiful" was written by ...

- A. Whitney Houston.
- B. Francis Scott Key.
- C. Katharine Lee Bates.
- D. Teddy Roosevelt.

Answer: C. Katharine Lee Bates wrote this beauty in 1895 while taking in a breathtaking view from the heights of Colorado's Pikes Peak. Get your own look at the Rocky Mountains' purple mountain majesty on Page 15.

No. 2

In 1956, President Eisenhower signed the Federal-Aid Highway Act. How many miles of highway did it authorize?

- A. 26,000 miles
- B. 41,000 miles.
- C. 100,000 miles.
- D. Unlimited.

Answer: B. Signed on the front-end of the Cold War, the driving motivation (wink) behind the act was actually military: to be able to rapidly mobilize in case the Cold War got hot. Fortunately, it didn't, and campers got a massive highway upgrade. (Just another reason to like Ike.)

No. 3

How many national parks does the U.S. currently have?

- A. 50.
- B. 63.
- C. 84.
- D. 107.

Answer: B. With the most recent addition of New River Gorge National Park in 2020, our national park count is up to 63. The entire national park system has over 424 locations, but that would include national memorials, battlefields, and other sites.

No. 4

Which city is the oldest European-founded colony in the U.S.?

- A. Jamestown, Virginia.
- B. Plymouth, Massachusetts.
- C. St. Augustine, Florida.
- D. Detroit, Michigan.

Answer: C. Founded by Spain in 1565, St. Augustine predates English Jamestown by 42 years, and French Detroit by 137 years. However, none of the Europeans found the "New World" uninhabited. Their earliest records describe a land full of diverse and vibrant indigenous cultures.

No. 5

It was Patrick Henry who said, "Give me liberty or give me death."

- A. True.
- B. False.

Answer: A. True, but what most folks don't know is where he said it—as he entered an RV dealership. (OK, that part may not be true.) But even so, we love and live Mr. Henry's ethic every time we take our RV on the road.

No. 6

About 85 percent of RVs in the U.S. are manufactured in this state:

- A. Indiana.
- B. Pennsylvania.
- C. Texas.
- D. California.

Answer: A. Indiana is indeed the birthplace of the vast majority of RVs you see on the highways and in the campgrounds. Included in that number: the glorious American Coach Patriot. Take a close look at Hoosier craftsmanship on Page 72.

No. 7

What was the first year that the Fourth of July was celebrated with fireworks?

- A. 1777.
- B. 1801.
- C. 1876.
- D. 1963.

Answer: A. That's right! Like true Americans, we got started right away. The first year following America's Declaration of Independence was celebrated with clanging bells, big ole fires, and explosive fireworks. (And we've only gotten better since.) Check out some of our favorite fireworks shows on Page 49.

American Vista

VANTAGE POINTS OF AMERICAN BEAUTY

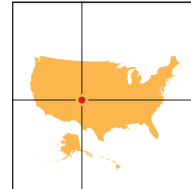

▶ ROCKY MOUNTAIN NATIONAL PARK	▶ COLORADO
▶ 40°21'58"N, 105°33'39"W	▶ NPS.GOV/ROMO



Photo: Shutterstock.com/ Anna Krivitskaya

TAKING THE HIGHEST ROAD You come to a place of exalted vision. To be surrounded by the titanic heights of the Rocky Mountains and all their purple mountain majesty is to be humbled by the grandeur and magnitude of American beauty. More than 100 peaks exceed 11,000 feet. On each side of the mighty Continental Divide, rivers flow forth and search out the shining seas of both the Atlantic and the Pacific. And as your RV winds its way from pass to pass—with all the earth below—you cannot escape the feeling that you're on the very doorstep of the skies.



**Scramble Up
to a Beautiful
Chasm.**

An unforgettable finish to an unforgettable hike that's worth every ounce of sweat. It's popular so start early and follow the East Longs Peak Trail for 3.2 miles. Then veer left onto Chasm Lake Trail. Scrambling over rocks, follow the rock cairns to reach Chasm Lake—ironically above you.

**Nearest
Parking Lot
Coordinate**

40° 16' 20" N,
105° 33' 24" W



**A Majestic
Moment
at Sprague
Lake.**

Don't be fooled: Not every view in the Rockies is earned with blood, sweat, and tears. Sprague Lake's circular track is flat (wheelchair accessible), family friendly (less than a mile long), and full of fantastic views (with benches to enjoy them)—all mirrored across the peaceful surface of this alpine lake.

**Nearest
Parking Lot
Coordinate**

40° 19' 15" N
105° 36' 28" W



**Chasing
Tyndall Creek's
Rocky Tail.**

Emerald Lake Trail takes you on a tour of four lakes—Bear, Nymph, Dream, and Emerald—as you trace the westbound progress of Tyndall Creek. At two points, just before you reach Dream Lake, the creek crosses the trail itself. All along the way, the creek cascades over rock until it climatically tumbles into the waters of Emerald Lake.

**Nearest
Parking Lot
Coordinate**

40° 18' 43" N
105° 38' 43" W



Ascend into the mountains and behold the blue jeweled lakes that reflect their glory.

Heading northwest out of Denver, there is a road that leads to the mountains—U.S. Route 36 West. An hour-and-a-half drive brings you through Estes Park to the national park's eastern gate at the Beaver Meadows Visitor Center. Already, you're on a 48-mile stretch of US-34 known as Trail Ridge Road—the highest highway in the U.S. of A. Just shy of 20 miles up the road, you'll reach the paved 12,183-foot summit of America with views equal to your imagination. As you drive, you'll see more than geology on a grand scale. There's an incredible diversity of ecology in the park—from forests of spruce and fir to tundra and wilderness where the majestic and muscular forms of bighorn sheep, moose, elk, and mule deer roam. True, you can see plenty from the cab, but you'll also want to take in the mountain air on foot.

“Where Should We Camp Next? has over 300 campground reviews both inside and outside of the parks! What national park do you want to visit next?”

— Stephanie and Jeremy of The RV Atlas

FIND YOUR NEXT STOP

Stephanie and Jeremy Puglisi of The RV Atlas just published Where Should We Camp Next? (And it's already the #1 New Release in the camping category on Amazon.)



Rock some Rocky-themed sunnies! Shop shades at goodr.com.

ADVENTURE

AWAITS...



Make the most of this summer with a KZ-RV Connect lightweight travel trailer - quality craftsmanship you can rely on for years to come.



(800) 768-4016

Go. Camp. Live.

KZ-RV.com

Designed for Campers by Campers!



Experience ultimate quality and comfort this summer in a Venture RV Sonic X ultra-lightweight travel trailer.



(888) 988-8440



venture-rv.com

Photo: Pages 16-17: Shutterstock.com/Sean Xu/ Pages 18-19: Shutterstock.com/SL Art/ Pages 20-21: Shutterstock.com/Sergey Malomuzh/ Page 22: Shutterstock/Alife Photography/ Jamie Carroll/ Kelly vanDellen



WHENEVER, WHEREVER, WE MAKE YOUR EXPERIENCE BETTER.™

Road Abode

IMPROVING LIFE ON THE GO



INSIDE: Three recipes for every RV grill master. Page 35 →

Kick All the Cooking Outside

IT'S SUMMER, BABY! And while we all love the look of that beautiful tiled backsplash that's classing up the galley, we can do without the heat of cooking inside. But the truth is, some RVs have a better outdoor kitchen setup than others. Some RVs just live to take the sizzle into the Summer sun. On the next page, we'll show you the features behind our five favorite outdoor kitchens.



BECOME A MEMBER OF OUR RV COMMUNITY

We want to keep moving the RV industry forward by inviting you to connect with other campers, share your ideas and experiences and unlock solutions that have not yet been addressed or solved!



JOIN TODAY!
Scan or visit the link:
community.lippert.com



Photo courtesy of Platinum IV

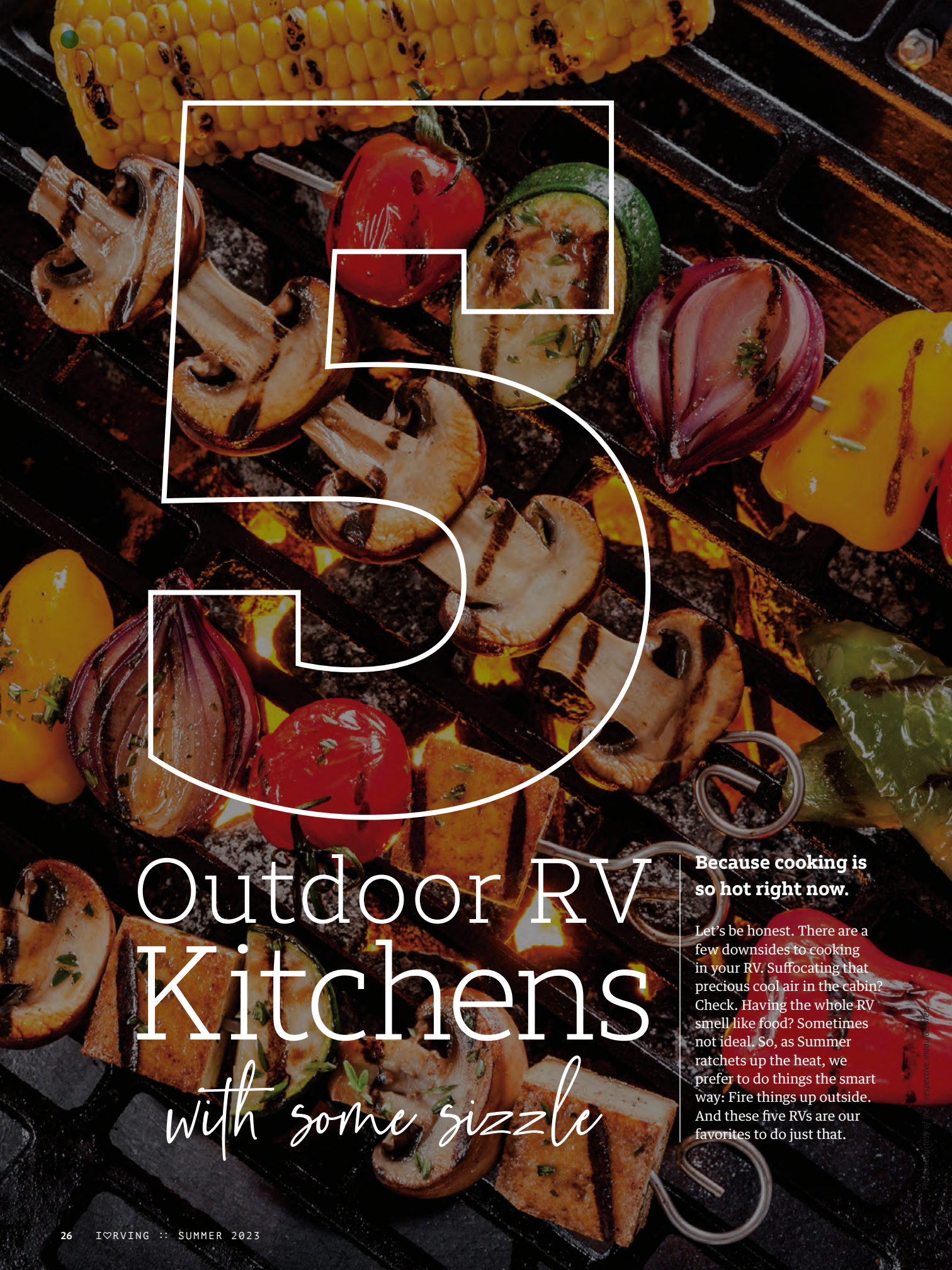

Outdoor RV Kitchens *with some sizzle*

Because cooking is so hot right now.

Let's be honest. There are a few downsides to cooking in your RV. Suffocating that precious cool air in the cabin? Check. Having the whole RV smell like food? Sometimes not ideal. So, as Summer ratchets up the heat, we prefer to do things the smart way: Fire things up outside. And these five RVs are our favorites to do just that.

OPUS Camper OP4

Comprehensive Tent Cover

Because Summer is hot and so is cooking.



1

Even the best outdoor RV kitchens can feel a little two-dimensional. Not the OP4. It's a pop-up camper in every sense with kitchen surfaces and amenities that roll out, prop up, and impress—going three-dimensional to give you extra space to work your culinary magic. And, with its LED exterior lights, cooking after dark has never been easier.



Sink with Hot Water On-Demand

Rinse stuff off in an instant.

Vertical Spice/Dish Rack

Just another place the OP4 adds space.



4-Burner Stove

Cook multiple things at once like a Top Chef.



Energy-Efficient 12V Fridge

Love that this is top-opening.

Slide-out Stainless Steel Kitchen with Chopping Board

Really increases your room to maneuver.



ROK OF AGES

Ember RV Overland Micro ROK

Our buddy Nate (see Page 76) says that having the kitchen outside erases any temptation of just chillin' in the cabin. The Overland Micro ROK (Rear Outdoor Kitchen) gets that and kicks you outside—like a good mom. Further, its features show a clever mastery of the essentials: cooking space, shade, and cool drinks.

Awesome 8-Foot Awning
Just the right amount of shade for a micro. Plus, the ROK latch covers you while you cook.



Surprising Kitchen Space
The ROK makes cabinets and shelf space priority.



32-Inch 12V Flatscreen Television
Cooking takes time and TV helps pass it.

Griddle vs. Grill
The griddle gives you more cooking surface.

Portable Cooler ... I Mean Fridge ... I Mean Freezer
Enjoy dual-zone cooling—and space for 114 cool ones.



THE ULTIMATE TAILGATE

Lance 2075 Travel Trailer

In outdoor cooking, we're often rankled by the absence of counter space. The Lance 2075 solves that by placing the kitchen across the full-width of the 8-foot tailgate, which is covered by an awning.



Fold-Away Stove and Sink
Slide it out. Use it. Slide it back. It locks in.

Slide-Out Ice Chest
A conveniently refrigerated drawer.

Less noise
Less energy

More airflow
More cooling



The RV Airflow System optimizes the airflow of your RV A/C system, increasing airflow by an average of 40%, improving performance and speeding cooling times while reducing noise and energy usage.

Get Less AND More with RV Airflow Systems.
Visit rvairflow.com or Call (574) 536-2472





OUR LITTLE CLASS C SECRET

Entegra Coach Odyssey 26M

Class As, Bs, and Cs are not known for their outdoor kitchens. But like the mythic (and mischievous) Odysseus, this Odyssey 26M has some tricks up its sleeves (including a Jayco-branded bottle opener on the cooktop drawer).

Capital Grill Cooktop

Big on outdoor flavor. Low on flame.



Mini-Fridge

Who wants to go back inside for a drink? No one.



2-Burner Cooktop

Multitasking requires multiple burners.

Quick-Connect Faucet and Collapsible Sink

When you need a sink, nothing else will do.

Tucked-Away 12V Fridge/Freezer

Love this Houdini-level reveal.



SMART TPMS - MADE FOR RVs

- Smartphone Based Tire Monitoring
- Compatible with Your Favorite Smartphone
- View up to 22 Tires Simultaneously
- Quick Setup and Automatic Alert System
- Voice Alerts and Push Notifications
- 3 Year Warranty and Lifetime Support

RV AIR PORTABLE COMPRESSOR

- 150PSI MAX 12V Compressor @23 Amps
- Fast and Quiet Operation (60dB)
- Includes High Precision Gauge (±1PSI)
- 2x 30FT of Hybrid Air Hoses
- 1HR Runtime (100% @ 100PSI Duty Cycle)
- 3 Year Warranty

STOP, POP, AND ROLL OUT

Winnebago EKKO

When you're ready to get dinner going, just follow the drill: 1) Put it in park; 2) Pop the outdoor kitchen latch open; and 3) Roll out the EKKO's ultrasweet kitchen suite. The design is clever and involves a lot of sleight of hand with now-you-see-me-now-you-don't features. ❤️



5

Photos courtesy of their respective manufacturers



SCAN HERE TO SEE OUR PRODUCTS IN ACTION OR VISIT: www.TireMinder.com



20X AWARD WINNER
12 YEARS IN A ROW



20X AWARD WINNER
12 YEARS IN A ROW





Rekindle the Flame

Small upgrades can make a big impact on how much you enjoy your RV.

Admit it! You've been daydreaming about that fantasy RV. (We saw you eyeing those models on Page 71.) Their features are super sheik, and upgrading to a new RV is something you've been thinking about. Even so, your budget may not have caught up to your RV fantasy life.

In the meantime, giving your current RV a little love in all the right places can make an enormous—and cost-effective—impact. Custom touches go a long way in personalizing your cabin's space. And best of all, they don't require a big commitment in time or money. With your current RV, you're already hitched.



LIGHTING

SHINE BRIGHTER ... OR DIMMER

Light has an extraordinary ability to create atmosphere. What do you want your cabin to feel like? Fixtures you can dim make a space feel more sophisticated—or romantic. Brighter lights add energy. Shop either option at SalVinCo.com that covers both.



FILTRATION

FRESHEN UP YOUR WATER

Stocking your fridge is a great joy of camper life. But we don't always love refilling it with water bottles. Unfiltered water from the RV tap isn't our favorite either. Fortunately, CLEAR2O Countertop Water Filtration System is an easy solution.



TEMPERATURE

QUIET AND COOL THE CABIN

Your AC may be secretly influencing you. If you're always fighting with the temp and hearing that drone. Doesn't sound like a place to chill, does it? But that's AC, not your RV. Upgrade with the Dometic FreshJet 3 for a quieter cool.



NEW PAINT

GIVE YOUR CABIN A FACE LIFT

Repainting your RV can make it feel brand new. (And it's relatively cheap.) But don't forget that you need to sand and wipe down your walls first to get the paint to adhere well. It's pretty simple after that: Prime and paint.

Photo: Shutterstock/CL_Shebley



Premium RV Sanitation

THAT'S NOT ME YOU SMELL, I SWEAR! MY HUMANS DIDN'T USE WALEX.

Walex makes premium holding tank treatments that deodorize, liquefy solids, and keep sensors & plumbing functioning so you can enjoy your adventure—odor-free and worry-free.



GIVEAWAY!

Win a 1-year supply of Walex products! Enter by finding the contest post on our Instagram, @WalexAdventures.



SUNDANCE

ULTRA LITE



LIGHT ON WHEELS. HEAVY ON FEATURES

Sundance Ultra-Lite models are lightweight and easy to tow – but looking at a list of features, you wouldn't know it. Chock full of amenities like solar prep, colossal storage, outdoor griddles and luxury fireplaces, Sundance has the soul of a luxury RV in a more modest footprint. And with more than 20 floor plans to choose from, there's a configuration to fit almost anything you have in mind for your next trip, whether you're roughing it or glamping like royalty.



LAUNCHING LIFE'S JOURNEYS

Visit Heartlandrvs.com to tour Sundance floor plans.

Get That True American Flavor

Give these outdoor classics just the right touch on the grill to perfect the taste of freedom.

by Marc Acton

The Ultimate American Burger



Ingredients

- 1 ½ pounds of 80/20 lean ground chuck
- 1 teaspoon kosher salt
- ½ teaspoon black pepper
- 5 brioche buns
- Leftover bacon grease
- Ketchup
- Chipotle chili powder to taste
- ¾ teaspoon smoked paprika
- Mayonnaise
- Dijon mustard
- Crispy pickles (spicy okra if you're adventurous)
- 5 slices American cheese (or fresh mozzarella if you're feeling fancy)
- 5 leaves Bibb lettuce
- 5 slices tomato

AMERICAN CUISINE IS A POTLUCK OF FLAVORS.

But the often-overlooked centerpiece is grilling. Philadelphia resident Ellsworth B.A. Zwoyer patented the idea for charcoal in 1897. Great American Henry Ford mass-produced the “fuel of a hundred uses” in 1921. By the 40s, as post-war Americans moved to backyard-filled suburbs, an American tradition had taken fire. Charcoal would fuel backyard grilling for families nationwide, with big hunks of meat appearing on paper plates in every state. (And it hasn't gone out of fashion.)

Here are three tasty ways to give your Summer a truly American taste.

➔ There are an infinite number of killer burger recipes. But if you're going to celebrate this all-American meal, don't church it up. Instead, create a complex medley of flavors with simple ingredients. No need for moistening agents. (We're cooking burgers, not meatloaf.) Let the beef shine. While it may look basic to the eye, there's a Rocky Mountain of flavor here that'll hit your tongue like the first note of your favorite song.

Prep some homemade ketchup by adding smoked paprika and chipotle chili powder to taste in ½ cup of ketchup.

Mix the ground beef, salt, and pepper in a large bowl, avoiding the temptation to over-mix, which can cause a meat-

ball consistency. Instead, stir the meat enough to disperse the salt and pepper and call it a day.

Divide the meat into five equal portions. Form your patties and then add a deep thumbprint in the center, which will keep their middles from plumping up during cooking.

Cook the patties on a smoking-hot grill. Leave them on for at least three minutes before flipping, ensuring a significant crust on the bottom that will help maintain patty integrity. Each flip costs you juice, so the ultimate goal is to flip only once or twice. Cook to your liking, typically seven to eight minutes. (Just know anything over medium makes Betsy Ross cry.) And whatever

you do, don't smash your patties, as the juice that comes oozing out the sides when you do would be better served ending up in your mouth.

As soon as you take the patties off to rest, apply your cheese slices. (You can do this while still on the grill, but that can get messy.) Then, slather bacon grease on your buns liberally and put over heat to toast while your patties rest. Butter works fine, but bacon grease adds the perfect subtle, smoky note to the bun. Toast until browned and crispy, which might be as little as 10-15 seconds or one minute depending on how hot your grill is. Watch closely to avoid burning. Assemble and carefully avoid overstuffing.

Photo: Shutterstock.com/lag_cz



Cheap-Cut Pork Butt

The secret to low-and-slow meats is that typically the cheaper the cut of meat, the better the outcome. Pork butts are perfect. Get the bone-in version for maximum flavor, and don't trim off any fat or skin until you're done cooking (and consider not doing it then either, especially if you're going to use a BBQ sauce, which will mask the fatty texture but maintain flavor).

Ingredients

- 2 tablespoons brown sugar*
- 2 tablespoons smoked paprika*
- Liberal salt and pepper*
- 1 ½ tablespoons garlic powder*
- 1 ½ teaspoon dried Italian seasoning*
- 4-pound pork butt or Boston butt*
- High flashpoint oil for oiling the grill*
- 2 cups beef broth*



Mix dry ingredients together, then rub on the butt. Leave meat out for one to two hours to get to room temperature prior to cooking.

Lightly oil your grill grates, place an aluminum pan under them, and add broth. Cook over indirect heat, ideally maintaining a consistent 225 degrees F for about five hours. You'll need to add coals or wood as you go to maintain this. Two hours into cooking (or before, if your meat is charred more than you'd like), wrap your butt in aluminum foil to lock in moisture and avoid burning.

Remove when the meat has reached an internal temperature of 190 degrees F and let rest for 20 minutes.

Now the fun begins, because a pork butt is one of the most versatile cuts of meat in the world. You can add sauce after the initial cook, like BBQ, brown sugar bourbon sauce, or just your pan drippings with a liberal splash of vinegar. It's great both fresh off the grill and in leftover form for tacos, nachos, BBQ sandwiches, rice bowls, pasta dishes—basically, just about wherever you can put meat, you can put pork butt. Fry it and you've got carnitas. Slice it and you have perfect roast pork sandwich meat. Pull it apart with two forks and you've got pulled pork.



Reverse Seared Cowboy Ribeye

Reverse searing combines the flavor-inducing slow cook with the caramelized goodness of a great grill sear. The cowboy ribeye is the perfect cut for it because it's bone-in, with plenty of marbling. The process might sound intimidating, but it's strangely very easy. This recipe takes almost no time to prep, has incredible wow-factor, and is the perfect main course to celebrate your freedom to enjoy delicious grilled meats.

Ingredients

- 1 tablespoon each of salt and pepper*
- 2 to 3-pound cowboy ribeye, 2-inches thick (bone length doesn't affect cooking)*



Heat grill to 250 degrees F, with an indirect heat zone. Cook steak for about 1 hour, until internal temperature reaches 115 degrees, then remove.

Set up the grill for 400 degrees of direct heat. Sear steak for about 5 minutes per side, until it reaches your desired temperature. Remove and let rest for 5 minutes with a tin foil tent. Consider adding a thick pat of butter to the top. Serve in all its cowboy-worthy glory.

Photo: Shutterstock.com/Igor Nemmann



All Seasons Construction for Luxury Comfort

Alta Xtreme 365

- 5" VACUUM BONDED CROWNED ROOF*
- 3" LAMINATED AZDEL SIDEWALLS*
- DUAL PANE WINDOWS*
- TRIPLE INSULATED FLOORS*
- FORCED AIR & HEATED UNDERBELLY*
- RESIDENTIAL INSPIRED APPLIANCES*



#GOEASTTOWEST

WWW.EASTTOWESTRV.COM

Photo: Shutterstock.com/Brent Hofstake/AMVPhoto



You bring the toys.
We provide the sandbox.

Fishing. Boating. Kayaking. Nature walks. Here in Big Pine Key and Florida's Lower Keys, every day holds new adventures. Especially with two wildlife refuges, epic ocean views, miles of unspoiled wilderness and everything from cozy campsites to full-amenity RV parks. Add Stock Island's delightful restaurants and rustic charm, and you'll never run out of opportunities to go outside and play.

fla-keys.com/lowerkeys 1.800.872.3722



Photo: Shutterstock/Adam Goldberg Photography

EDGE OF THE MAP

FROM THE HIGHWAY TO THE CAMPGROUND

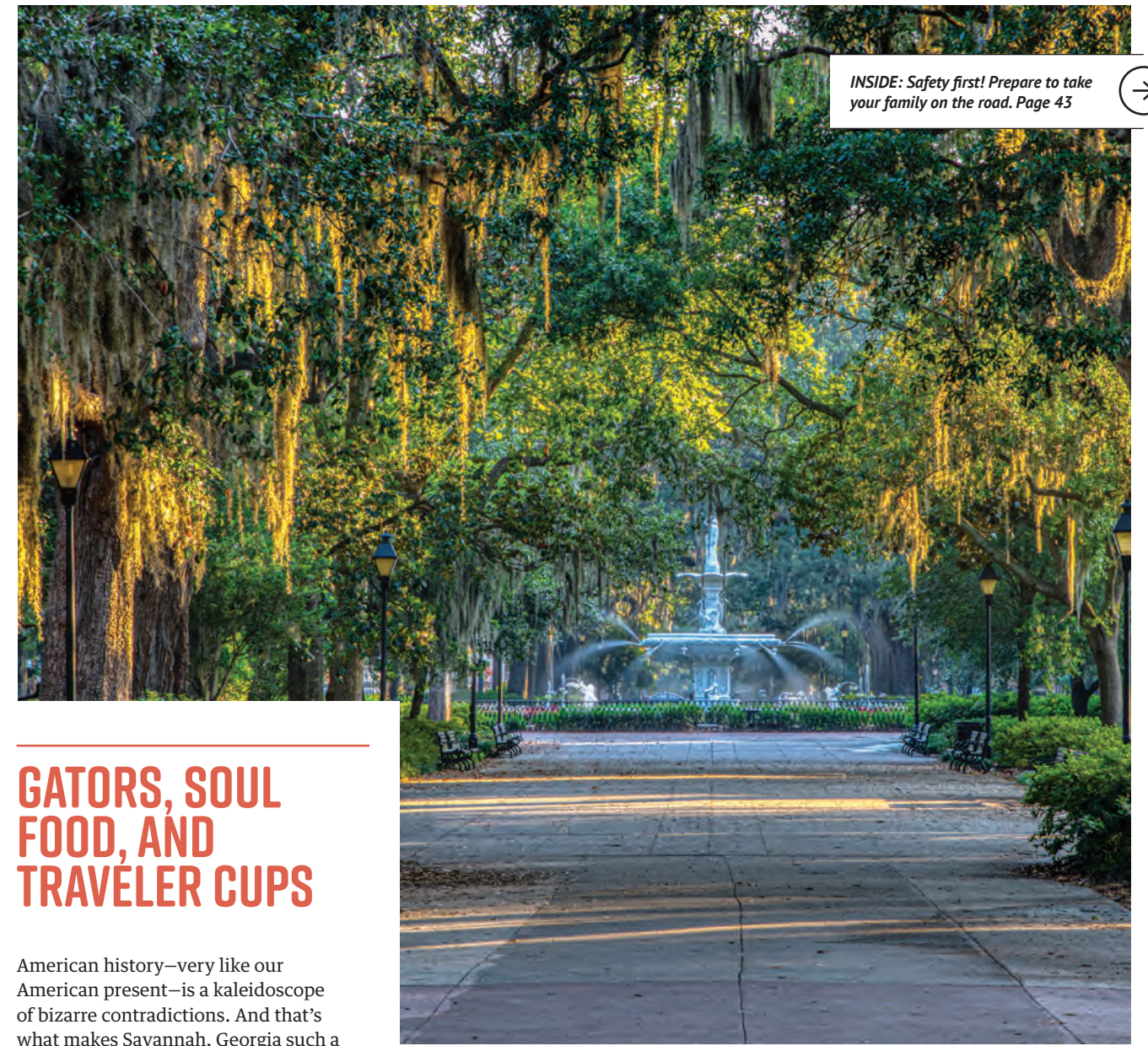

INSIDE: Safety first! Prepare to take your family on the road. Page 43



GATORS, SOUL FOOD, AND TRAVELER CUPS

American history—very like our American present—is a kaleidoscope of bizarre contradictions. And that's what makes Savannah, Georgia such a fun destination. Gators on golf courses. Cocktails in a prohibition museum. (You can even have a “traveler” downtown.) On Page 52, step inside the stylish new CreekFire Resort that plays the perfect Southern host to RV guests—and offers cool refuge from the blue blazes.

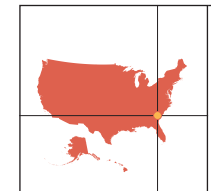

▶ CREEKFIRE RV RESORT	▶ SAVANNAH, GA
▶ 32°5'6"N, 81°4'55"W	▶ COVECOMMUNITIES.COM

Exploring the Face of the Nation

Take the whole family on a shamelessly American summer road trip that they'll always remember.

THE ROAD IS AN UNRIVALLED TEACHER. As street-wise students ourselves, we can attest to that. And we know that our kids—in their predriving years—will only learn what we show them. So, why not show them the very best? (More on that on Page 60.) Imagine a trip where they could walk into the unadulterated wilderness of Glacier and Yellowstone National Parks. Where they could stand in the place where history happened and hear the stories that define us. Where they could explore our nation—body and soul.

From the Pacific Northwest's shining sea to the rock monument at Mount Rushmore, you can do just that this Summer. Not only will you make memories that will last a lifetime, you'll give your kids a clearer picture of who they are as Americans—and a sense of gratitude for the natural treasures they've inherited.

Washington State to Washington's Face

Starting your journey in Seattle, you'll begin a straight shot east toward the heart of the American wild. Taking I-90 East over 300 miles through Spokane and across the Idaho border, you have yet another 90 miles or so till you break into Montana. Around St. Regis, you'll have the option to take Exit 33 and sprint north onto MT-135 North if you want to detour toward Glacier National Park. Otherwise, you'll continue on I-90 for another 400 miles southwest toward Yellowstone. At Exit 333, you can take US-89 South toward America's first national park entrance near Gardiner. After you have seen your fill of geologic wonders or—more likely—have used your allotted time, head back north along US-89 to continue your

eastward progress along I-90. Almost immediately, the landscape will begin to transform into rolling ridges and ravines with rivers and streams, especially as you cross into the Crow Reservation where Little Bighorn lies. Continuing south, you'll swing back east, always on I-90, and cut the northeastern corner of Wyoming before entering South Dakota. From here, you're within 100 miles of the magnificent stony gaze of our foremost presidents at Mount Rushmore.

Taking Some Time in Rapid City

One of the best things about Rapid City and the Mount Rushmore National Memorial is that it's free. (*Merica!) Parking, however, is a slightly different story. You'll need to pay a small fee of \$10 per vehicle for your parking ticket, but it lasts for an entire year. (*Merica again!)



A Stone-Fired Pizza Primer
 Finally arriving at Yellowstone is a big day for everyone. Before you drive through the northern entrance, make a stop for the ultimate crowd-pleaser: Pizza. No whining. No fighting. Just smiles and that mmm-mmm sound as kids eat stone-fired slices and you tear into a special with buffalo sausage.

A Perfect Place to Pedal Around
 Whether you're a family of cyclists or you just keep the bike rack ready for the right moment, do not—we repeat—DO NOT let yourself drive by Trail of the Coeur d'Alenes. There are 73-miles of smooth, paved trails—perfect for bikers of any experience level. And the views are among the best on the planet. Frankly, biking with the family here is the kind of memory that everyone will always remember.

Make a Stand at Little Bighorn
 Little Bighorn is one of those places—like Gettysburg—where history comes alive. Stepping out of the RV, you can watch your kids' imaginations run wild as they envision the rolling battle across the open hills, the heavy sound of hoofbeats, and the crack of rifle fire. For the home-schooling parent, it's a gift-wrapped history lesson like no other.

Get a Glimpse of the Old West
 Deadwood is about as close as we've gotten to time travel. While its home to the graves of western legends like Wild Bill Hickock and Calamity Jane, don't be mistaken: Deadwood is far from a ghost town. The historic district is great fun for the whole family, and when you're ready to return to the 21st century, you can go off-roading in the Black Hills.

MAP KEY Educational Adventure for Kids RV-Friendly Gas Stations RV Service Center Special Chow



SUN CYCLE™ ADVANCED LITHIUM BATTERY

100AH ADVANCED LITHIUM SMART BATTERY

The NEW Sun Cycle® Advanced 12V 100Ah Lithium Battery adds enhanced safety and communication features to our flagship lithium battery line. This lightweight, Bluetooth-enabled LiFePO4 battery has an advanced BMS with a built-in smart DC heater, inter-battery balancing for series batteries, reserve capacity feature and convenient mounting features.

- ✓ Bluetooth®-enabled, smart features and RV-C compatibility
- ✓ Built-in DC heater
- ✓ IP68 waterproof (should not be submerged)
- ✓ Built-In Mounting Options
- ✓ 10-year warranty
- ✓ Improved Battery Management System (BMS) protects against:
 - Over and under voltage
 - Over and under temperature
 - Charge and discharge over current
 - Short circuit



 **Bluetooth®** **RV-C** Compatible

Learn more at
[GOPOWERSOLAR.COM/ADVLITHIUM](https://gopowersolar.com/advlithium)



Better Safe Than Stranded

13 ESSENTIALS TO PLAY IT SAFE IN YOUR RV, WHETHER YOU'RE IN DRIVE OR PARK.

A long time ago—in the increasingly ancient-but-still-awesome 1980s—Michelin captured our attention with the tagline, “Because so much is riding on your tires.” We might be dating ourselves a bit (that’s happened before), but that line still comes to mind every time we start planning a big RV road trip. And it should, because for an RV in particular, preparing to travel safely across the country goes far beyond tires.

Sure, there are some things that we

shouldn’t have to say here ... but we will. I mean, you have RV insurance, right? And no one would park without wheel chocks. (We hope.) As for your RV tires themselves, we’re sure you remember Mike Pescitelli’s awesome—and comprehensive—article last issue. (Keep that one for life.)

So what else does that leave us? Tons, my friend. So let’s dive into some safety essentials that help give you an edge against Murphy’s Law as you travel with the people you treasure most.

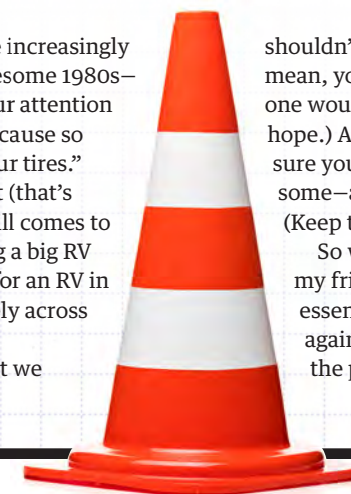

Photo: Shutterstock.com/makasma photo

Safety for the Road

PREP FOR WHEN YOU HIT THE PAVEMENT.



TIREMINDER A1AS TPMS

TIRE PRESSURE MONITORING ON CRUISE CONTROL.

Anything that's going on with your tires—yeah, you wanna know about that. Like immediately. On a screen. Not on the side of the road with your family after you've had a blowout. Having a tire pressure monitoring system (TPMS) is nonnegotiable. The A1AS is top of the line that not only monitors your PSI but also your tire temp.

Price varies with number of transmitters

THE HUB SAVER

FOR WHEN YOU ACTUALLY LOSE YOUR BEARINGS.

Imagine a scenario where part of your wheel bearing disintegrates. This happens. And when it does your hub and wheel can fly off—as you're driving. However, with Hub Saver installed, your hub and wheel assembly are kept on their axles (where they belong). And that buys you valuable time to find an exit and a repair shop.

\$39.95 at TheHubSaver.com

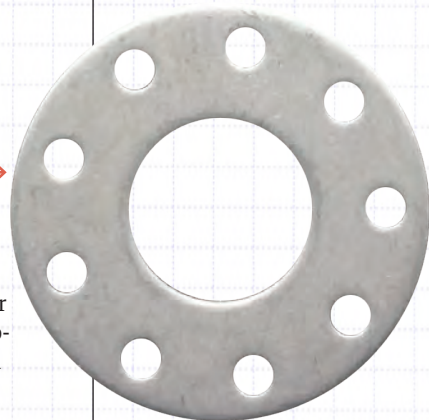

TEKONSHA P3 TRAILER BRAKE CONTROLLER

SHOW WHO'S IN CONTROL BACK THERE.

To control your trailer is to control its brakes. And the P3 maximizes control of up to four axles with big, fat, simple buttons that are easy to find and use while driving. The screen is equally easy to read. Which gives you even more time to act.

\$159.50 on Amazon

B&W COMPANION FIFTH WHEEL HITCH

MADE IN THE U.S.A. AND HELD TO HIGHER STANDARDS.

There are recommended practices for manufacturers testing trailer hitches before they go to market. B&W blows those standards out of the water for a simple reason: They're on the road too. Trailers should be safe. And B&W makes it so.

Price varies by hitch



See B&W's superior—and safer—way of testing.



EQUAL-I-ZER ONTARGET TOWING TOOL

FASTER WEIGHT DISTRO CALCULATIONS.

Weight distribution isn't the kind of thing you want to figure out as you're swaying down the road. So you have two options: 1) Grab a pen and make a manual calculation, or 2) Use the OnTarget towing tool and ditch the math. We like one option better than the other, and not just because it's easier. Weight distro impacts your driving, and you need to get it right.

\$79.95 at EqualizerHitch.com



SAFE-T-PLUS STEERING CONTROL

KICK WHITE KNUCKLES TO THE CURB.

When you're out on the highway, guess what? There's gonna be wind. And semi-trucks. And potholes. If you're always swaying, get ready for a lot of white knuckling with your fam along for the ride. So, smooth your cruise. Do a simple one-hour install and let the Safe-T-Plus steering control unit take all that pressure off.

Price varies by unit



EXPLORE
more

ALASKA MARINE HIGHWAY

Alaska is wild and full of adventure. See more by walking or driving aboard a state ferry to access dozens of scenic coastal communities along our 3,500 mile route.

FerryAlaska.com | 1-800-642-0066

f y i #alaskamarinehighway

Photos courtesy of respective manufacturers

Protection While in Park

FOR LESS WORRY AND EASIER SLEEP.

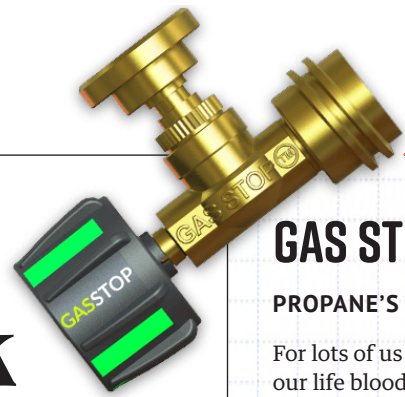

GAS STOP

PROPANE'S PERFECT OFF SWITCH.

For lots of us camping out there, propane is our life blood—in the RV and out. Leaks can be dangerous, but Gas Stop enables you to instantly and automatically shut off the supply. You can even test for minor leaks, and a gauge gives you an idea when your tank is getting low.

\$74.00 on Amazon



MIDLAND WR120 NOAA WEATHER ALERT RADIO

WARNINGS WHEN SECONDS MATTER MOST.

It's easy to simply rely on those pocket computers we call cell phones to warn us about dangerous weather. But the problem is that our phones rely on cell towers—which dangerous weather can knock down. With Midland WR120, you get weather watches and warnings from the National Weather Service for your area—whether there's cell service or not. And that can make all the difference.

\$39.99 at MidlandUSA.com

REESE TOWPOWER HITCH LOCK

NICE TRY, RV VILLAIN. NOT THIS TRAILER.

While we admit that we might enjoy stirring a little RV envy, we all want to live in a world where no one would ever steal another person's trailer. But sadly, we don't live in that world. Having a solid trailer hitch lock at least removes the opportunity for theft when you make a stop.

\$21.00 on Amazon

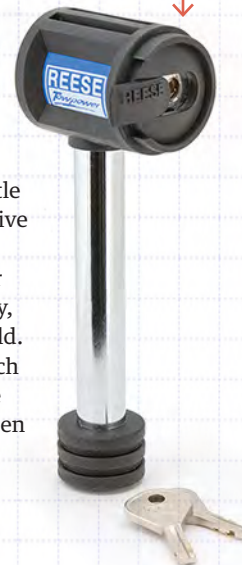

BAUER NE BLUETOOTH

MORE SECURE. NEVER LOCKED OUT.

RV locks aren't exactly Fort Knox. Even so, don't even think about losing that key. The Bauer NE Bluetooth fixes both problems. Secure, encrypted, and easily paired with a mobile device, it even keeps track of its locking/unlocking history. Say goodbye to all fear of getting locked out.

\$239.99 at BauerProducts.com



Photos courtesy of respective manufacturers



VOYAGER CAMERA SYSTEM

CAREFUL. YOUR RV HAS A BADONKADONK.

Backing up the RV can be a big joke ... until it's not. Being able to see where your RV's massive rear end is going can have big consequences for life, limbs, and property. Voyager has several RV camera systems that can act as your virtual rear-view mirror.

Price varies by system

Keep cool in peace.

Don't suffer through a loud A/C. Get an RV A/C silencer!

- Noise reduction
- Better filtration
- Increased air flow
- Simple installation



"It works fantastically. I will be ordering a second one for the back bedroom A/C."

- Rod B., San Diego, CA

Order an RV A/C silencer today!
WackOProducts.com/IHeartRVing



CAMCO POWER GRIP VOLTAGE PROTECTOR

PROTECT THE PEOPLE'S POWER.

We all love shore power, but the truth is that you can't always trust it. Without a voltage protector, your entire electronic suite is living dangerously, just hoping one heavy jolt doesn't wipe everything out. The Power Grip protects against faults for reverse polarity and automatically disconnects when dangerous conditions occur (and reconnects when normal conditions are restored).

\$446.72 on Amazon



BYRNA BGR MAX

AND A LITTLE PEP IN YOUR STEP

Kind of like OFF! spray for bigger pests.

Self Defense Pepper Spray, \$24.99



LIFETIME NO LEAK GUARANTEE

The Only Professionally Sprayed On Seamless Watertight Roof With Unmatched Thickness

NO MORE

- Maintenance
- Caulking
- Leaks
- Punctures

FREE Estimates.
FREE Roof Inspections.
Locations Near You.



CONTACT US FOR AN ESTIMATE
(844) 353-9276 RVROOF.COM

21 NIGHTS
COMPLIMENTARY*
CAMPING

\$ 1 0 0 0 VALUE

Call us today!

855.481.7411

CALL WITHIN 7 DAYS TO RECEIVE YOUR **SURPRISE BONUS GIFT!**



MAKE GEORGIA YOUR NEXT STOP!

Fifty-five acres make up our beautiful North Shore Resort at Lake Oconee, GA. The campground was developed with a "railroad" theme and 23 railroad cars were brought in and used as offices, in recreational areas, as shops, and as overnight accommodations. Club cars, cabooses, and boxcars were used in the design scheme giving the resort a truly unique flavor for your next vacation stay.



THE BEST CAMPING ON THE RIVER!

The perfect vacation destination located directly on the picturesque Mohican River in the heart of Ohio's Amish country. At Wally World you'll have the best camping sites on the river at a clean and family-oriented campground. With access to a full range of amenities and easy access to so many area attractions you'll want to come back again and again!



RELIVE THE GETTYSBURG EXPERIENCE!

Located on the southern edge of the most famous Civil War battlefield, our amazing campground resort provides by far the best setting for the perfect family getaway. Whether you're soaking up American history or sun by our Olympic size swimming pool, you will discover unlimited opportunities for epic fun and relaxation at Gettysburg Battlefield Resort.



FLORIDA FUN!

Whether you enjoy fan boat rides through the Florida wetlands, viewing world class wildlife, horseback riding, boating, fishing for largemouth bass, ziplining, Busch Gardens in nearby Tampa, Orlando attractions such as Disney and Universal Studios, attending a pro sporting event such as The Tampa Bay Buccaneers or just hanging at the resort pool, Thousand Palms will meet all your vacation needs.



RELAX AT BASS LAKE!

Our activities and events are second to none, and take place year-round. Not to mention our two outdoor swimming pools; two club-houses, one for families as well as one just for the adults; a miniature golf course; a restaurant and bar, a country store; nature trails, for both short walks and long hikes; laundry facilities and much more. As a gated and secure year-round resort, there's always a comfortable, safe and warm sense of community.



NORTH CAROLINA AT ITS BEST!

Come experience one of North Carolina's most beautiful campground resorts, located just minutes from historic Pinehurst. Explore and enjoy everything Sycamore Lodge has to offer, from our historic main lodge and 200 acre forest to our private stocked lake, beach and swimming pool.



LIFE'S AN ADVENTURE, ENJOY THE RIDE!

Located in the Salt Fork Lake Region. With over 850 pristine acres, this resort truly has something for everyone. Nestled in one of Ohio's most spectacular forests. You don't even need to leave the ranch for an adventure-packed vacation as amenities include: indoor heated pool, outdoor pool, horseback riding & trails, golf driving range, mini golf, paintball and so much more!



CAMPGROUND GUIDE

Firework Frenzy

Celebrate the Fourth by parking by some of the nation's most spectacular illuminations.

Cherry Hill Park

9800 Cherry Hill Road
College Park, Maryland 20740
(301) 937-7116

Road Trip: Watching fireworks fill the sky and illuminate the myriad monuments and memorials around DC's Washington Mall is a Fourth of July like no other. Each year, the performance lineup for the **PBS Capitol Fourth Concert** is star-spangled with big names and military band salutes. Admission is free on the West Lawn of the Capitol building—but expect to be among a flood of freedom-lovers (and like it). *21-minute drive*

Daily Rate: \$98-129
Camp Sites: 400+

WATER	STORE
SEWAGE	LAUNDRY
ELECTRIC	WI-FI
PROPANE	PET-CARE

Check-In/Out: 12 pm/11 am
CherryHillPark.com

Village Scene RV Park

2151 Koffel Road
Hatfield, PA 19440
(215) 362-6030

Road Trip: Finding a campground—with the full hookup—within an hour of Philadelphia is a real feat, but the Village Scene RV Park is it. Beautiful and serene, it's also within striking distance of the stunning **Wawa Welcome America Festival**. Celebrating the Fourth of July in the city where the Founding Fathers signed the Declaration of Independence and wrote the Constitution is a bucket-list experience. *41-minute drive*

Daily Rate: \$46
Camp Sites: 34

WATER	STORE
SEWAGE	LAUNDRY
ELECTRIC	WI-FI
PROPANE	PET-CARE

Check-In/Out: 12 pm/11 am
VillageSceneInfo.com

Rip Van Winkle Campgrounds

149 Blue Mountain Rd
Saugerties, NY 12477
(845) 246-8334

Road Trip: For sheer firepower, it's hard to imagine anything topping **Macy's Fourth of July Fireworks** in New York City. Shells burst up to 1,000 feet in the air, coloring the Big Apple's iconic skyline. (View from Gantry State Plaza in Brooklyn so you get that amazing backdrop.) The East River sparkles with magnificent reflections. The scale awes you and—what's more—the pyrotechnic glory continues for 26 minutes. *2-hour drive*

Daily Rate: \$73-79
Camp Sites: 40+

WATER	STORE
SEWAGE	LAUNDRY
ELECTRIC	WI-FI
PROPANE	PET-CARE

Check-In/Out: 12 pm/11 am
JoshuaTreeLake.com

Normandy Farms Family Camping Resort

72 West Street
Foxboro, MA 02035
(866) 673-2767

Road Trip: Boston has a well-earned reputation of partying pretty hard for patriotism. (The harbor may yet have tea strains.) And each year the **Boston Pops Fireworks Spectacular** seems to get even grander. Singing the national anthem with a half-million other Americans. Military jets soaring by. Music from the Boston Pops Orchestra filling the air. All you can say is, "God bless America!" *47-minute drive*

Daily Rate: \$71-146
Camp Sites: 355

WATER	STORE
SEWAGE	LAUNDRY
ELECTRIC	WI-FI
PROPANE	PET-CARE

Check-In/Out: 3 pm/12 pm
NormandyFarms.com

CALL 855.481.7411 TODAY OR VISIT US AT TRAVELRESORTS.COM
This offer is sponsored by Travel Resorts of America and includes up to 21 nights of complimentary camping and a 90-minute VIP tour (some restrictions apply). No purchase necessary. All camping certificates are redeemable at any of our private resorts and valid up to one year. These certificates entitle you up to 7 nights of complimentary camping during peak season, and two certificates of up to 7 nights each of complimentary camping during non-peak season. These certificates have no cash value and are non-transferable. Offer not valid if you have toured one of our resorts within the last 24 months, if you are a current Travel Resorts of America or Coast to Coast member, or you keep your RV on a permanent site. Please call toll-free at 1-888-481-7411 to activate your certificate. Calls will be recorded for training and compliance.

Your Next Getaway Plan

Cool Fall campgrounds for killer colors and great college football.

Watch the Game Wherever You Park This Fall

Save \$50 on a DISH Outdoors Bundle with this special I Heart RVing offer.

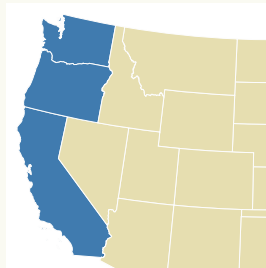

PACIFIC

South Prairie Creek RV Park

South Prairie, WA
SouthPrairieCreekRVPark.com

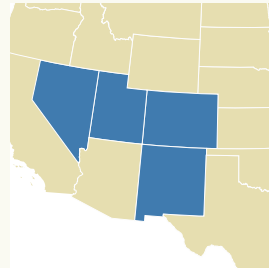

MOUNTAIN

Clear Creek RV Park

Golden, CO
CityOfGolden.net

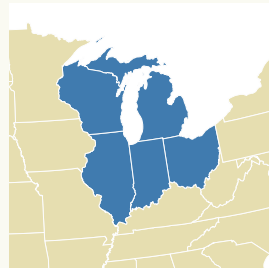

MIDWEST

Walnut Hills Family Campground

Durand, MI
WalnutHillsFamilyCampground.com

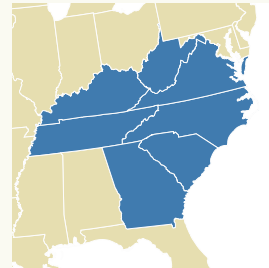

APPALACHIA

Campground Margaritaville RV Resort

Pigeon Forge, TN
MargaritavilleResorts.com

- Less than an hour south of the University of Washington, South Prairie Creek RV Park keeps you one step removed from the bustle of Seattle—and dead center amid the exquisite Washington wilderness. With over 188 full hookup sites, you can use it as a home base to explore the temperate rainforest around Olympic and Mt. Ranier National Parks.

- Buffalo football may have seen better days, but like Fall, there's a feeling of change in the air. And speaking of air, it doesn't get much better than Colorado. Clear Creek RV Park is just west of Denver and a half hour south of Boulder. Run by the little town of Golden, it's small, clean, and surrounded by golden aspens— perfect for a crisp, Fall retreat.

- Michigan is a dream house of deciduous forest that explodes with color come Fall. Just east of East Lansing and an hour of Ann Arbor, the Walnut Hills Family Campground is not only well situated for Big Ten football; it's perfectly placed for outdoor fun. Covered in forest, surround by trails, and loaded with activities for freshwater fun, the whole experience is a touchdown.

- The Great Smoky Mountains (or the "Smokies" as the locals call them) are a spectacular Autumn sight—drawing visitors by the thousands each year to see to their multicolor slopes. The brand-new Campground Margaritaville RV Resort parks you right in their shadow. So you have deluxe amenities, miles of wilderness, and Big Orange football just an hour up the road.

I HEART TIPS

Circle October 14 against Oregon and November 11 against Utah on your Washington Huskies calendar. Both are home games and could shape who wins the Pac-12.

I HEART TIPS

We already hear you: "Colorado football?! What is this? The 90s?!" Listen, we don't care. Coach Prime has our attention. Watch and see how much is just talk against USC on September 30.

I HEART TIPS

Whether you wear Wolverine blue or Spartan green, you're in a great spot. On October 21, drive 34 minutes to East Lansing to see who takes home the Paul Bunyan Trophy.

I HEART TIPS

Last year, when Tennessee played Georgia in Athens, it was a Top 3 matchup of SEC teams. They play again this year on November 18 ... but in Rocky Top. Get those tickets early!

CONTINUUM™

WEIGHT DISTRIBUTION HITCH

The whole point of a weight distribution hitch is getting the correct amount of weight moved from the rear axles to the front axles of your vehicle. Current weight distribution hitches take an all-or-nothing approach: loaded or unloaded. Our composite LITEFLEX® bars make it possible to fine-tune your setup with just the pump of a handle.

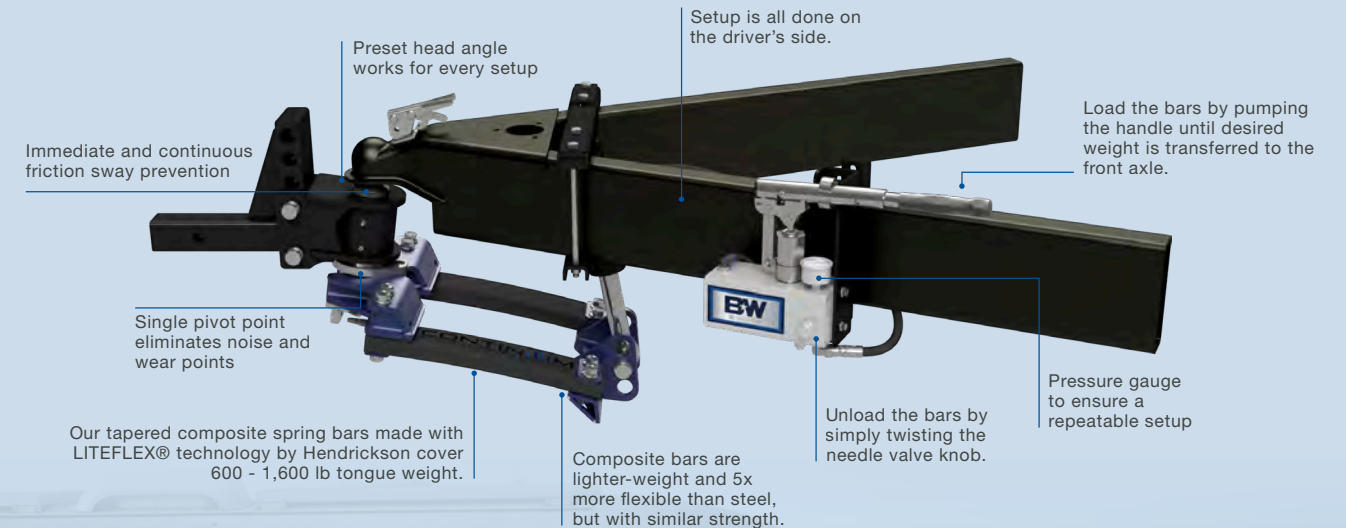

Georgia's

SOUTHERN SURPRISE



EXPERIENCE THE HOSPITALITY OF ONE OF THE SOUTH'S MOST REFRESHING RESORTS JUST OUTSIDE ONE OF AMERICA'S OLDEST AND MOST INTRIGUING TOWNS. *by Mark Settle*

SAVANNAH HAS ALWAYS SEEMED strangely comfortable living between two opposites. Cooled by the lush green shade of live oaks and cold currents of river water that flow down to the coast, Savannah blithely lounges amid a sweltering Georgia heat. If the locals make luxuriating look easy (and they do), understand that they have centuries of experience finding that deft balance—between Old Colonial Europe and the New World, past and present, guest and host, home and vacation, history and memory. So, for the RVer searching for the old soul of the American South—with all its charm and contradiction—there's no better city to explore.

Georgia just might be the strangest of the original thirteen British colonies. A penal

colony that originally outlawed slavery, befriended the natives, and fought the Spanish, it's a quick reminder just how interesting—and deliciously complex—history can be. And make no mistake: Georgia's first city is as intriguing today as it was then—if not more so.

Movie watchers may know the town's face from films like "Forrest Gump" and "Midnight in the Garden of Good and Evil." But every savvy RV adventurer should know that Savannah—like its most charming and stylish campground—always rewards you for sticking around a little longer. (That's Rule No. 1.) Because just when you think you know everything about little ole Savannah, like history, it surprises you.



→ **The Grand Entrance**

Descending on the last legs of its Atlantic-hugging course, Interstate 95 cuts across the northwestern corner of Savannah. Southbound in your camper, you've entered the land of eternal pine and uninhibited humidity. Veering right toward Exit 94 toward Pembroke onto Georgia 204 West, you keep right and are quickly confined on each side by two lofty walls of trees. Then less than a mile out, on your driver's side, the land breaks open. Clear acreage with white, ranch-rail fencing levels out the view and makes room for blue sky to finally touch the earth. Turning left into the drive, you arrive at CreekFire Resort. And what a grand entrance it is.

Susie, the manager of the resort and originally a native of Maine, confesses that since she moved south that she's had to get used to some

new things—like the locals. (We're talking about alligators, snakes, and all their cool-blooded cousins, here.) But even now, she remains in awe of the resort's entrance. She laughs, "Pulling up to CreekFire is one of the greatest things. When you pull in, you've got that white fence lining both sides of the streets. Straight ahead, you see a big, big white building, almost like an old historic house—very similar to what you'll find in downtown Savannah."

Driving through the brick entryway, you'll park in a spacious cul-de-sac with four wide pull-through spots that run parallel to the house. While its squarely angled roof and omnipresent porch may evoke the local sense of architecture, the white house is one of

the most recent—and stylish additions—around town. When CreekFire Resort opened its doors in October 2017, Matt Litman, the original owner, built it to be an RV resort for families. (Hence the roomy parking accommodations.) Cove Communities took over a year ago, making it one of their 55 prized properties that span the U.S., Canada, and the U.K. on the other side of the Atlantic.

Exiting your RV, you walk straight into the white house. Inside, the front desk meets you directly. Six fulltime employees work the desk, and guests often find themselves getting checked in by the very person that booked them on the phone. The great house is open and airy, flooded with light from antique windows. Looking out and

"PULLING UP TO CREEKFIRE IS ONE OF THE GREATEST THINGS ... STRAIGHT AHEAD, YOU SEE A BIG, BIG WHITE BUILDING, ALMOST LIKE AN OLD HISTORIC HOUSE—VERY SIMILAR TO WHAT YOU'LL FIND IN DOWNTOWN SAVANNAH."

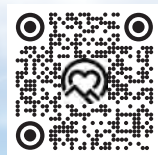

Get a closer look at CreekFire Resort.



Photo courtesy of Creekfire RV Resort

towards the back, you'll start to get your first glimpse of the expansive amenities behind the house.

If the white house is like a hospitable host that greets you, the recreational facilities are like the music of children in the backyard. (Not that the fun is for kids alone.) A heated pool lies directly behind the house, coupled with a hot tub. To the left are tennis, pickleball, and basketball courts. To the right, there's a sand volleyball court. Going deeper you'll find a bar and grill, billiards room, laundry, bathhouse, and firepit. Yet still deeper a lazy river completes a languid circuit with a clear view of a giant splash pad for kids. After receiving your placard, car pass, map, and directions, you'll be eager to get parked in one of the resort's 211 campsites so you can explore more.

Naturally, amid all this abundance, you may feel like you've seen it all. You haven't.

Surprise: There are two sections to the resort, and the second isn't immediately visible. Farther back, cloaked by tree cover,

there's a lake. There, you'll find more campsites, seven cabins for rent, and a nature trail that tracks the circumference of the water. However, the lake itself is not for swimming. (Because, you know, alligators.) But the best surprise of all is the restaurant on the water, aptly named The Lake House. Open Thursday to Saturday from 4 p.m. to 9 p.m., The Lake House serves Southern specialties like shrimp and grits, peach cobbler (this is Georgia, after all), and locally caught fish. Any guest can come, drink, and dine in the open air—all while watching gators cruise by like Confederate ironclads.

Gators on the golf course?!

Watch a gator put-put across the green.



IT'S YOUR ADVENTURE. BRING IT.

Exclusive options. Built to order.

DESIGN YOURS:
KINGSTAR.NET/ADVENTURE

CALL:
480-686-1302 or 906-275-5000



Li³ghting Your Next Adventure

Take your campsite to the next level, with the plug-and-play Outlaw 1072S Portable Power Station. Built exclusively for off-grid adventure, Outlaw packs 921-watt hours of clean lithium power. That's enough to keep you going through the night. And then some.



RELi³ON

LEVEL UP YOUR CAMPSITE



"This book is a must-have if you're planning a camping trip to a national park — whether you are a seasoned camper or a first-time visitor."

ActionHub

AVAILABLE NOW

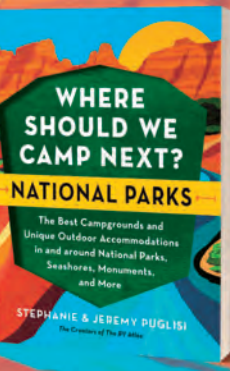

STEPHANIE & JEREMY PUGLISI

sourcebooks



Trolleys, Town Squares, and Traveler Cups

Whether you're ambulating around CreekFire Resort or trekking the cobblestone walkways of Savannah's historic district, things move along at a more leisurely pace. And that's good because each experience is to be served and savored like a thick drop of molasses.

From the resort, guests have the option of being picked up by Old Town Trolley (for a small but sensible fee). The trolley takes visitors directly downtown, picking up folks from the resort between 9:00 and 9:30 a.m. for a hospitable one-hour tour. Afterwards, you can hop off and take in the city on foot, hopping back on whenever you like to jump over to the next city square of choice. (There are 22 in all.) It's a lazy convenience to be indulged and gives you remarkable freedom to explore. Because the trolleys are everywhere, you can easily find the next one as you crisscross the town, take in the gorgeous antique architecture, and share the road with horse-drawn carriages. You can stroll through the beautiful and iconic parks, like Forsyth, and sit on benches once shared by Forrest Gump.

Spending so much time on foot is also a great opportunity to immerse into the best part of Savannah: the culture. And Susie, CreekFire's manager, says there's no better place to do that than the city's exquisite Forsyth Farmers' Market. (All while stocking up on fresh food for the galley while you're at it—see Page 35.) Recalling her first time there, Susie says she was surprised that not only was there fresh produce, a wide variety of cheeses, jams, and kimchi; the market was also flooded with artists of all types teeming the street. Young painters from the Savannah College of Art and Design come out to sell their work. Susie laughs, "There are vendor poets who will write you something on the spot!"



Photo: Shutterstock/digireamgrafix

Photo: Shutterstock/Danyil Brooksy/featyurvegetables/Jon Bilousy/Anton_Ivanov

4 Things you just gotta do



1 Take a Savannah Riverboat Cruise

There are brunch cruises and sunset cruises, gospel cruises and sight-seeing cruises. Whichever floats your boat, you'll wanna choose one.



2 Sit on the "Forrest Gump" Bench

I may not be a smart man, but I know what fun is. It's sitting on that bench in Chippewa Square, taking selfies, and talking to total strangers in a Bama accent.



3 Have a Drink at the Prohibition Museum

Order whatever you like at this irony-soaked speakeasy, but when it comes time to make a toast, raise your glass and say, "To prohibition!"

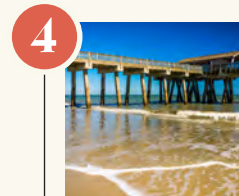

4 Hit Tybee Island's Beachfront

Just 20 minutes from downtown Savannah—and 45 minutes from CreekFire Resort—spend a day or two cooling your travel-weary self in the Atlantic.

Susie also shares an important local secret: If you're eating downtown, get reservations in advance. That's an absolute, whether you're eating crab cakes at Vic's on the River on Savannah's magnificent riverfront or at the Olde Pink House, one of the oldest and best venues for Southern comfort food (and also, the old headquarters for the occupying Union general, William Tecumseh Sherman). Great dining options are everywhere, whether you're hankering for fancy alligator fritters at Alligator Soul or a premium pimento cheese sandwich at Husk.

Savannah's bar scene is simply the stuff of Southern legend. Sorry Charlie's Oyster Bar & Cocktails keeps a special Fish House Punch on tap, along with a menu of colorfully named cocktails—like Painkiller. And Captain's Lounge makes a good follow-up. But the one to absolutely not miss is getting a drink at—wait till you hear this one—the American Prohibition Museum. (No, we're not kidding. It has a speakeasy.) Wherever you go, keep in mind Rule No. 2 (from "Midnight in the Garden of Good and Evil"—the film: If you have to leave a party, you always take a traveler. In Savannah, if it ain't in glass, you can take your libation with you.

Cooling Off in the Blue Blazes

With all this fancy footwork you're doing downtown under the Georgia sun, your return to CreekFire Resort will never be more welcome. You may have heard a local say, "It's not the heat ... it's the humidity." The truth is that it really can feel hotter than the blue blazes in the Summertime, but the resort has the exact accommodation guests need for an epic cool down. It can be neatly summed up in two words: lazy river.



Sure, there's the splash pad where the kids can safely get wet and go wild within sight. Sure, there's the swimming pool and the spa. But that lazy river. Man! That's the ticket. Susie and the resort staff themselves

DESIGNED SO WELL, YOU'LL NEVER MISS HOME

CLASS A MOTORHOMES

PURSUIT | MIRADA | ENCORE | SPORTSCOACH
(RD & SRS)



SPORTSCOACH
RD 41 ITS SHOWN



Coachmen
Recreational Vehicles

A division of Forest River, Inc.

www.coachmenrv.com



EDGE OF THE MAP

→ can't help but smile as they watch their guests soak it in. "Our pools are definitely our main attraction. In the summertime, our splash pad area is usually filled with the younger kids and, of course, their parents."

Then she chuckles, "The lazy river, you know, you would think that would just be for kids, but—quite frankly—I probably see more adults in that river. It's located right next to our pool bar and grill, so a lot of times they go get their frozen drink, cocktail, or beer, get in their little floatation, and relax on the lazy river with their cold drink in hand."



Yes, and yes. Just what the doctor ordered.

Even more, Susie says that everyone enjoying themselves at the pools and recreation areas has an impact on resort culture. "It really turns into a family resort. There are kids everywhere over in the sports courts area playing games. Obviously in our splash pad or on our lazy river." She pauses, "It really turns into a community of families."

Folks come from all over the world to experience that kind of community. Older couples and retirees often snowbird over Winter and then stay on. Traveling nurses frequently check in too. Families come from everywhere—whether that's the neighboring Carolinas or from Canada and the U.K. They all keep coming back. Back to that lazy river. Back to The Lake House and its gator-filled waters. Back to the damp heat and the cold drinks. To the resort that fills their calendar with karaoke, dance parties, water aerobics, and RV rallies. To the place where their trash is picked up and their propane can be filled before they hit the road again.

Small wonder they return each season. The draw is no mystery. It's Savannah's ever-so-predictable recipe for comfort and hospitality that—somehow—always still leaves a little room for surprise. ❤️

RVX



INSIDE:
Get ready
for some
freshwater
fun, you water
dog! Page 68

CAMPING, ADVENTURE, AND THE RV EXPERIENCE



TAKING THE FAMILY TRIP OF A LIFETIME

There are no flyover states when you're RVing. But not every mile is created equal. That's why we've selected our seven most family-friendly, America-loving road trips. Drive them and get a fuller picture of the glory, glory, hallelujah that makes America great. But know this: Searching out each wonder and encountering your fellow Americans won't just change you—it'll change your entire family. See why on the next page.

Photo: Shutterstock/ Margaret Wiktor

★ ★ 7 ALL-AMERICAN ★ ★ Roadtrips



Great geysers and grand canyons are just a few of the national wonders your family will love. But behind each American journey is a bigger purpose: Shaping who your kids become.

by Marc Acton

Within the first five minutes of my conversation with Jamie Goncharoff, he made sure I knew certain things. He was a prior Marine; he used to be a volunteer firefighter; he paid his own way through law school by working the overnight shift at UPS; and he's not very impressed by people who say they've seen the Alps.

"So many people go to other countries without seeing the beauty and diversity of America," he says, before adding begrudgingly that the Alps (which he has seen) are, "great by the way." Sticking it to the Alps and the people who visit them is not really his point. It's just that he'd rather know, "Have you hiked in

the Rockies? Have you been to the five national parks in Utah?" You see, Jaime is a patriot, and he has the impression that his fellow countrymen and women are missing out on something truly special.

The numbers support that gut feeling. The average American has visited only 12 states, and, according to a YouGov poll in 2022, only three percent have visited 45 or more. Jamie Goncharoff, on the other hand, visited the entire Lower 48 before graduating college. That experience was so powerful, he did it again after getting married. Except this time, he brought his entire family with him.

"We had a goal to have our kids see

the 48 states before they graduated high school. So every Fourth of July as our kids were growing up, we would celebrate freedom in a different part of the country. Because fireworks are fireworks, but when you see them behind the heads of Mount Rushmore, they take a different hue." When asked what drove him to make that commitment, his response is crystal clear, "I wanted our kids to be able to love America, and appreciate the natural beauty, the diversity of our people and our culture."

See, for folks like Jamie, RVing isn't just one of America's greatest pastimes. It's a picture of what makes America great.

"It's freedom. You can stop wherever you want. You meet people, and you appreciate the beauty of America. Freedom is the hallmark of America. With RVing, it's having the freedom to move, stop, live, sleep, and eat—on your timetable. You're not checking into a motel at three in the afternoon and sleeping in somebody else's bed, and kicked out at twelve o'clock. You have the freedom to come and go, to experience things, and to meet people."

Not everyone may be ready to commit to seeing the Lower 48. To see some of

our nation's most glorious treasures, you can take it one trip at a time. Here, Jamie rides shotgun with us as we offer our take on the seven greatest American road trips. Take them, and you'll have experienced some of the best of what the ole U.S. of A. has to offer. (Whether you've seen the Alps or not.)



Leg No. 1
FOLLOWING THE FOUNDERS' FOOTSTEPS

- ▶ Starting Point: **Bar Harbor, ME**
- 🏠 Overnight: **Philadelphia, PA**
then **Boston, MA**
- 📍 Finish Line: **Washington DC**
- 🕒 Travel Time: **12 Hours**
- 🔍 Why Go: *Expensive lobsters, the birth-place of American government, the Freedom Trail, free history*

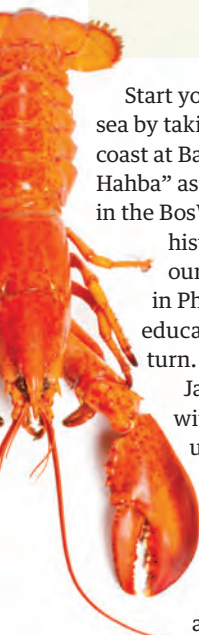

Start your romp from sea to shining sea by taking in the sights of our first coast at Bar Harbor in Maine (or “Bah Hahba” as the locals say it). Then take in the BosWash Megalopolis—home to history’s most raucous tea party, our nation’s first national capital in Philadelphia, and DC, with free educational opportunities at every turn.

Jamie recommends you start with a great view: “Take a hike up Cadillac Mountain [outside of Bar Harbor] in Acadia National Park and absorb the breathtaking views from the highest summit on the East Coast. Then land at sea level and enjoy the world renowned crustacean of Maine, the lobster, found everywhere—from downtown Bar Harbor to the local McDonald’s where you can enjoy a Mobster! In Philly, visit where our country memorialized the right to life, liberty, and the pursuit of happiness. Relive 1776 at Independence Hall where the Declaration of Independence was signed, or walk a couple of blocks and see where Betsy Ross sewed the first American flag.”



Leg No. 2
COCA COLA, DISNEY, AND THE FLORIDA KEYS

- ▶ Starting Point: **Atlanta**
- 🏠 Stopover: **Orlando**
- 📍 Finish Line: **Key West**
- 🕒 Travel Time: **12 hours, 50 minutes**
- 🔍 Why Go: *Coke Factory, Disney, Hemingway, our nation’s southernmost tip*



We like to think that a truly ‘Merican road trip should enjoy at least one healthy dose of capitalism. This leg has two, starting with a visit to Atlanta’s fantastic Coca Cola Factory. From the heart of the Dirty South, head even souther to Disney, another of America’s most iconic brands. Disney (and all of Orlando) is super RV-friendly, with Fort Wilderness being their official RV park. Disney crams every type, shape, and flavor of American into an overpriced-but-totally-worth-it place they call the Happiest Place on Earth. After that, you’re due for some time in one of the chilliest locations on Earth: Key West. Motor on south, cross the Overseas Highway, and then arrive at Hemingway’s favorite retreat.

John Steinbeck says: “For it is my opinion that we enclose and celebrate the freaks of our nation and our civilization. Yellowstone National Park is no more representative of America than is Disneyland.”

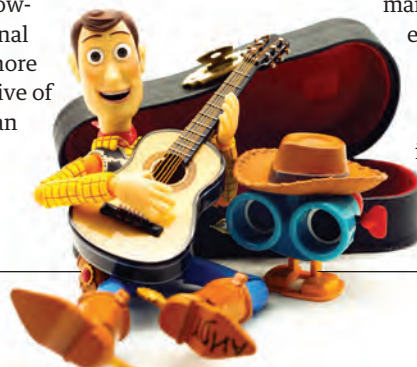

Leg No. 3
COUNTRY MUSIC, NASCAR, AND THE AMERICAN SPIRIT

- ▶ Starting Point: **Nashville, TN**
- Swing By: **Louisville, KY**
- 📍 Finish Line: **Indianapolis, IN**
- 🕒 Travel Time: **4 Hours**
- 🔍 Why Go: *Music City USA, bourbon trail, baseball, Indianapolis Motor Speedway*

Nashville might be line-dancing away from its countercultural country-western roots, but it’s still one of the best places to enjoy live music in the entire world. After you’ve boot scooted and boogied, take I-65 North to reach the southern start point of the Bourbon Trail and its 43 distilleries that celebrate “America’s spirit.” (Just don’t oversample!) Swing by Louisville (pronounced “LULL-vull”) and enjoy America’s favorite pastime at Louisville Slugger Park on your way to Indianapolis. Time it right and you’ll be joining the 325,000 people who visit Indy for the Indy 500. If you haven’t RVed at a big car race, there aren’t many American experiences like it. (Family bonus: Indy is also home to the largest children’s museum in the world.)

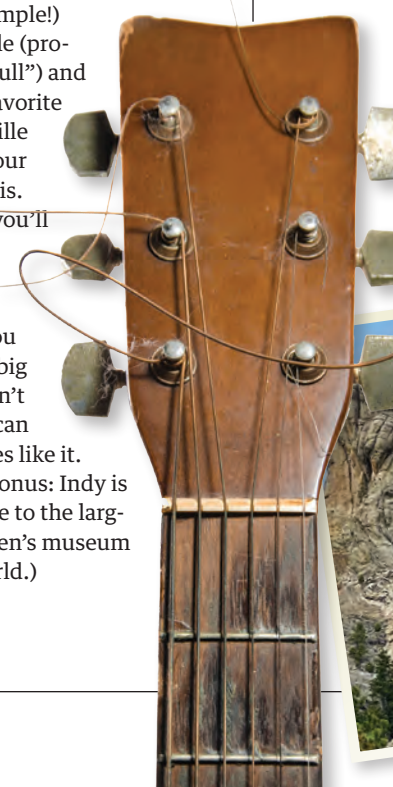

Leg No. 4
UNWORLDLY WONDERS AND GIANT IMPRESSIONS

- ▶ Starting Point: **Bozeman, MT**
- Swing By: **Deadwood, SD**
- 📍 Finish Line: **Rapid City**
- 🕒 Travel Time: **7 hours 50 minutes**
- 🔍 Why Go: *Yellowstone, the Old West, America on a Mountain*

Travel from Yellowstone to Rushmore is epic. (See Page 40.) Yellowstone is unlike any place on earth, with magnificent heights like its 10,900-foot Electric Peak and mercurial depths like the 50-meter deep Grand Prismatic Sprint, the largest hot spring in the U.S. Yellowstone is the most national of parks, with more natural diversity in its 3,471 square miles than most countries altogether. From there, stop by Deadwood, a town that is a replica of the gold rush and the U.S. westward expansion. Then finish at Mount Rushmore, an awe-inspiring marriage of American creativity and engineering.



A NEW PRODUCT BY
Magne Shade®

Magne Screen
by Hunckler Fabrication LLC
PATENT PENDING

Magne Screen™ is the exclusive magnetic awning drop shade for automatic awnings.

Magne Shade®
by Hunckler Fabrication LLC

MagneShade.com
336-753-0905

Teddy Roosevelt says: “There can be nothing in the world more beautiful than the Yosemite, the groves of the giant sequoias and redwoods, the Canyon of the Colorado, the Canyon of the Yellowstone, the Three Tetons; and our people should see to it that they are preserved for their children and their children’s children forever, with their majestic beauty all unmarred.”



SAFE T PLUS
Steering Control

The Better Ride product collection provide superior suspension systems upgrades that will give you a revolutionary driving experience.

Georgia Location:

634 Golf Course Road
Tallapoosa, GA 30176

Florida Location:

13152 SE County Hwy 484
Bellevue, FL 34420 (Ocala)



safe-t-plus.com

770-322-8727



RVX > ALL-AMERICAN ROAD TRIPS



Leg No. 5
PURPLE MOUNTAINS AND RED ROCKS

- ▶ Starting Point: **Denver, CO**
- 📍 Finish Line: **Moab, UT**
- 🕒 Travel Time: **6 hours and 30 minutes**
- ? Why Go: *The Rocky Mountains, Red Rocks, Arches*

It's hard to overstate the dramatic beauty of the Rockies. They are one of those American vistas that has to be seen, or hiked, or skied to be believed. Being near to both the enormity of mountains and the eternal nature of the land can change your perspective on life. (See for yourself on Page 15.) Then there are the Mighty Five National Parks of Utah. Each is worth a visit, but finish in Moab—the perfect launching point into either Canyonlands or Arches, with their weird and memorable natural landmarks.

Jamie says: “With RVing, you feel the land. You're not just flying over it. You get to experience things and make choices, like to take the back roads.” (We suggest taking them.)

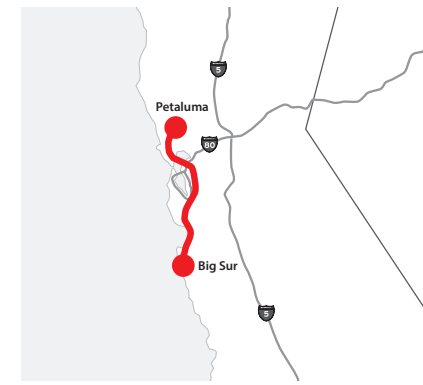

Leg No. 6
PACIFIC WAVES, TALL TREES, AND BIG SUR

- ▶ Starting Point: **Petaluma, CA**
- 📍 Finish Line: **Big Sur**
- 🕒 Travel Time: **4 hours**
- ? Why Go: *The Pacific Coast Highway, the tallest trees in the world, the Pacific Ocean*

You don't have to be an aficionado to appreciate the rolling hills and quaint towns of the northern San Francisco Bay wine country. It's an unusual amalgam of agriculture and high-net-worth culture. Thinking about that juxtaposition will keep you busy while being slathered in relaxation and world-class food. Then there's the Pacific Coast Highway where every curve holds a new breathtaking ocean view. At the southern end, you coast into the remote and organic calmness of Big Sur. You could stop for a round of golf at Carmel-by-the-Sea, but we'd suggest heading straight into the woods, which ooze with fairy tale romance.



Jamie says: “If you had to visit one state in the country, I'd say go to California. The diversity of the people, from Death Valley—which is nature's junkyard—to the beaches, to the redwoods, is unmatched.”



Leg No. 7
YOUR SAFE BET FOR A GRAND FINALE

- ▶ Starting Point: **Las Vegas, NV**
- Swing By: **The Hoover Dam**
- 📍 Finish Line: **Grand Canyon**
- 🕒 Travel Time: **2 hours**
- ? Why Go: *The world's biggest party, the world's biggest drainage ditch*

Vegas is one, big party. You can find just about anything you're looking for in the Neon Capital of the World. America was built on risk and reward, and Vegas is still playing that game (even if the house has the big advantage). Out of Sin City, head east to finish our most American road tour at the grandest of canyons.

Between Vegas and the Grand Canyon, the Hoover Dam stretches from Nevada to Arizona in the Black Canyon of the Colorado River. When Jamie, his wife, then-10-year-old Sarah, and then-14-year-old son Jamie Jr. arrived there, they all knew that crossing it would check off the last of the Lower 48. The plan was to park and walk across the dam to check it off. But leading up to this big moment, Sarah had made a deal with her dad to trick her older, faster brother into getting out of the RV early. Then Jamie could drive ahead and give her a head start in the sibling race to the last state.

“It was always a competition between them,” Jamie Sr. says, “Who would get into each state first. They'd always be



wanting to sit at the front of the RV as we crossed the state line to claim first place.”

But when the time came for her final masterful maneuver, Sarah changed her mind and ultimately followed her brother as they crossed. Later, her father asked her why she let her brother win. “She said, ‘Daddy, that wouldn't be right.’” Jamie remembers, “For her, it was about fairness, competition, not getting special treatment. She knew it wasn't about winning or losing; it was how she played the game. And that's living up to the ideals of being American.”

Today, Jamie Jr. proudly shares that his daughter is a schoolteacher; his son is a Marine officer. Each continues to live up to those ideals—about what they learned from their parents and about who they are as Americans. All while traversing the greatest country in the world. ❤️



Cleaner, better-tasting water anywhere you go

TastePURE

SUPERIOR RV Water Filters

GET 10% OFF WITH COUPON CODE: **IHEARTRVING10**

CAMCO OUTDOORS

To check out the entire collection, visit: www.CamcoOutdoors.com

Subscribe to our YouTube channel for tips & more cool products!

ON-ROAD PERFORMANCE. OFF-ROAD THRILLS.

SPRINTER 2.65" PRE – RUNNER SUSPENSION SYSTEM



EVICTUS



VISIT THE FIRST U.S. INSTALLATION PARTNER:

CALL (833) 667-0427 FOR
INFO AND SCHEDULING



Photo: Shutterstock/ Doptis



Whale Watching in Washington

ONCE YOU SEE THAT TALL, BLACK FIN cut through the waves in front of you, no doubt will remain: This was the best idea EVER. Till then, it's OK if you are skeptical about the wisdom and hassle of taking your RV to an island—so long as you still go. Nature has its ways of still flooring us as adults. And your trip to San Juan Island, just off the Washington State coast, is an opportunity for the whole family to feel like kids.

I Heart Tip

Watch the "Blackfish" documentary before you go—or better yet, "Free Willy"—to get properly hyped for seeing live orcas.

Get Your First Look at San Juan Island

It's unreal. This place is like Killer Whale City. Take a look.



WHY GO

Quite frankly, unless you live in Washington State, you've probably never done anything like this—ferrying your RV into the Pacific to reach an island circled by killer whales. On the island, there are boat tours with captains that know where to find the pods, but you don't have to go offshore to see the black fins of orcas cruising around the shorelines. Heck,

there are even listening stations where you can hear the whales talk!

WHERE TO GO

The Lime Kiln Point State Park on San Juan Island is one of the top whale watching spots in the world. (And killer whales are not the only whales you can expect to see.) Go there, but stay overnight at Lakedale.

WHEN TO GO

May to September



Pick Up YOUR Paddle

FRESHWATER FUN IS ONE OF OUR SUMMER FAVES.

THE HEAT IS ON, MY FRIEND, and Summer has a plan—to melt your face off. Which is fine by us, because we have a plan too—to grab our paddles and hit the nearest body of water. But where that is could depend on your favorite form of freshwater fun. Want the pulse-pummeling adrenaline rush of white water rafting? Or just a placid lake surface to slide across with the meditative motion of a chess piece? Done and done. This is America, baby. We have it all. The only question we got is where-oh-where to store our freshwater gear in the RV. (Time to clear off your roof rack for the kayak!)

Take a look at our four favorite things to do with a paddle, our favorite places to play, and our favorite toys to take into the water—as we laugh our heads off at Summer.



GLIDE ACROSS THE SURFACE
Aqua Plus Inflatable Stand Up Paddle Board
Sure, there are fancy paddle boards out there. We've seen them (on Instagram). But stand up paddleboarding (SUP, y'all) is a leisurely activity. And your kids are all gonna want their own boards. The Aqua Plus Inflatable SUP is an affordable option to outfit the whole clan. **\$199.99 on Amazon.com**



RIDE THE MIGHTY RAPIDS
NRS Paddle Wetshoes
One of the most glorious things about white water rafting is that you just show up. Commercial outfitters provide almost everything, from life jackets and helmets to the raft itself. You, on the other hand, just need two main things: the mindset of a champion! ... and some good wet shoes. (You don't wanna lose your regular kicks in the river.) NRS paddle wetshoes are light, comfortable, and give you traction if you need it. **\$63.95 on REI**

EXPLORE LIKE LEWIS AND CLARK

Sea Eagle Inflatable Travel Canoe 16
Having your canoe be inflatable is huge space saver for any RVer; and on the water, Sea Eagle Travel Canoe 16 leaves nothing to be desired. Having three seats makes it a lot of fun for families. Which means multiple rowers. And an opportunity to play Ben-Hur: "Ramming speed!" Wait. Don't do that. Just paddle. **\$1,799.00 on Amazon.com**



GO SOLO, YOU RUGGED INDIVIDUALIST

Eddyline Sky 10 Kayak
Don't think we're not aware: There are inflatable and even packable kayaks out there. And some are really innovative. But we still love recreational hardshells for their stability, maneuverability, and the very ease of transitioning into the water. No inflating or assembly. The Eddyline Sky 10 is great for beginners. **\$1,399.99 on REI.com**



Tank FRESH
Enjoy all the benefits of a **CLEAN WATER TANK** while on the road

clear2o.com

MADE IN THE USA

Light Your RV with Earth-Friendly LEDs

12v Bee Green LED lights and bulbs include:

- Extremely Low Profile Ceiling Lights
- Reading Lights with USB Charge Ports
- New Tech with Amazingly Even Light Patterns
- New 3-in-1 Color Temp Pancake Light with Dimmer
- Dual Color Fixtures and Replacement LED Bulb
- Variety of Fixture and LED Color Options

Save Power. Bee Green.
Learn more at www.beegreenled.com
941-378-9727

bee green LED
Sold by SalVinCo LLC

Pro RV gear reviewed by an RV pro.

Subscribe to the I Heart RVing YouTube channel for insights, stories, and knowledge that make camping immersive, convenient, and FUN!

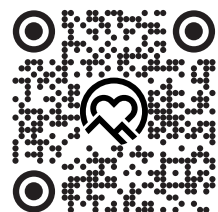

Scan to Subscribe to the I Heart RVing YouTube channel or visit [YouTube.com/@IHeartRVing](https://www.youtube.com/@IHeartRVing)



TOP LEVEL

RV TECH AND TRADECRAFT



INSIDE: Plug into a portable power station you can RELiON. Page 76



FREEDOM IS THE VERY AIR the American soul requires to breathe. And our heart leaps when we encounter an RV that champions all the things we care about: toughness, self-sufficiency, and individuality. The American Coach Patriot and KingStar Camino 88 have those rock-hard qualities in spades. But turn a few pages, and you'll see how both are also forging new paths—like good Americans—in innovation and luxury.

Worthy of the Spirit of '76

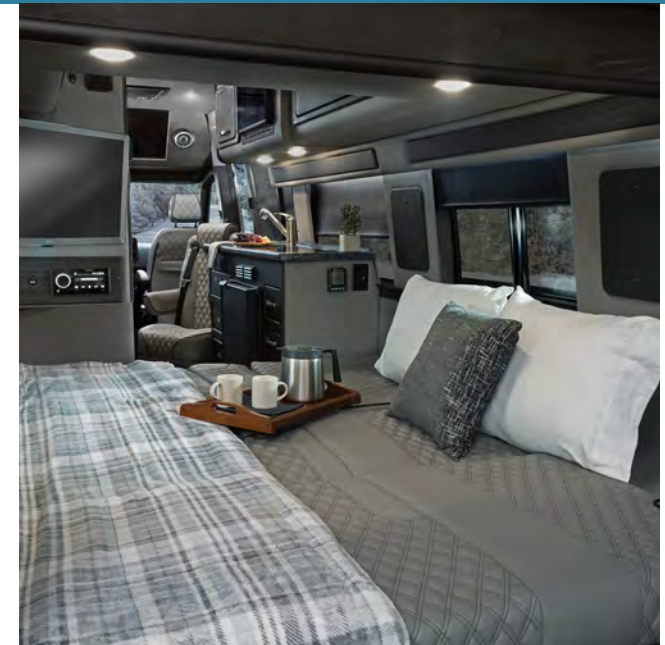

Self-Determination in the Cabin

The Patriot has idealistic standard features. Some are obvious—like three choices for the polished wood finish in the interior. (Walnut Burl Satin shown here.) Others are subtle—like the hidden hinges on the cabinets and wardrobe. Coach control is also standard with a digital touch screen. But the optional packages offer even more alluring touches. For example, the Legacy edition package includes a stunning rain-glass shower door, weaved flooring, and captains' seats with heat and massage features.

Freedom from Want in the Bedroom

As much as we love campgrounds (see Page 49), they are not always the most private place. But the Patriot makes your parking spot your castle, with tint for rear and side windows, privacy night shades for the front, and a privacy shade package standard. Which means that you and your passengers truly have the space to yourself. So you can chill on the sofa and watch what's on Apple TV. Talk through the night with drinks on the removable Lagoon table. Or set the mood on your JL audio surround system with Bluetooth and unfold the giant sofa bed.

The Patriot Declares Class B Independence

AMERICAN COACH HAS FORGED A LUXURY COACH WITH THE VERY SOUL OF FREEDOM.

THERE IS A DAUNTLESS COURAGE in the very act of creation—all the more so when it's tied to belief. And American Coach made its own restless ambition self-evident to the RV industry when it titled its revolutionary Class B "The Patriot." Innovative and fiercely independent, The Patriot 170 EXT MD2 fully represents the qualities of the craftsmen who make it, and the customers willing to pay a bill of rights for the freedom they value. The Patriot gives its owners a coach that is private, customizable, and geared for individualism.

Don't be deceived by the sleek appearance of the Patriot. While it is elegant enough for a ball, like General Washington, it is just as ready to storm key terrain. Powered by the formidable 3.0L V6 diesel engine on the battle-tested Mercedes-Benz Sprinter chassis (with an optional 4x4 drivetrain), the Patriot is a master of maneuver. What is remarkable is how smooth it is, upgraded with Sumo suspension that gives you additional control as you drive. Your visibility and awareness are further increased by a comprehensive rear back-up camera system. In park, the Patriot's roof-top solar charging system helps bear the load of energy logistics—even if you don't choose the 600Ah

Lithium Freedom Package that liberates you totally from the fetters of propane. Ultimately, your pursuit of happiness ends inside the Patriot's feature-spangled cabin. Its 13,500 Btu roof-top air conditioner and climate-controlled roof fan power a refreshing atmosphere—and its complete insulation package ensures the cool stays put. When the temperature drops in coming months, you'll be grateful for the on-demand water heater and diesel powered coach furnace. In milder weather, the Patriot gives you the right to let the outdoors in with side and rear screen doors. And there are plenty of amendments you can make—whether that's going all-electric (the Lithium Freedom package), fitting all-terrain tires with black rims, or installing the VB Air Ride System. Vote for any feature you like.

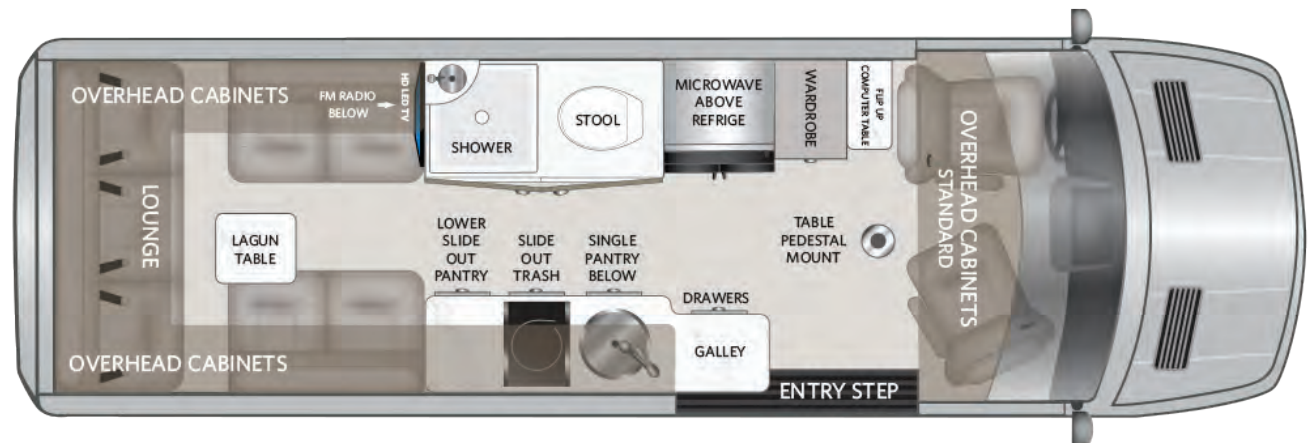

AMERICAN COACH PATRIOT 170 EXT MD2 FLOORPLAN

▶ CHASSIS MB SPRINTER 3500 4X4	▶ EXT LENGTH 24 FT 2 IN
▶ ENGINE MB 3.0L V6 TURBO DIESEL	▶ EXT HEIGHT 9 FT 2.6 IN
▶ GVWR 11,030 LBS	▶ EXT WIDTH 7 FT 11.5 IN
▶ GCWR 15,250 LBS	▶ FRESH/GRAY/BLACK 27/24/14 GAL

Photos courtesy of American Coach

Declare your own independence. Visit AmericanCoach.com.

Trucking Toward New Territory



Wherever the Camino 88 Leads We'll Follow

KINGSTAR IS REIMAGINING THE ENTIRE TRUCK CAMPING EXPERIENCE. AND WE CAN'T LOOK AWAY.

CHANGE IS A DIFFICULT MASTER. There's a lot of grit, intensity, and intentionality required to keep pace with a moving landscape—especially a market as fluid and crowded as the RV industry. But KingStar is getting something right in a very big way. Instead of grasping at the future, the Camino 88 line is forging it with a laser focus on the battle-tested

essentials. And it's bringing a smile to campers across the country and turning heads that may have once dismissed truck camping. The impact of a well-built thing is profound. It's the mark of integrity. The KingStar Camino 88 gives 1-ton truck owners with 6.5-foot and 8-foot beds—and flatbeds too—a slide-in camper that fits their rugged ethos. Framed with wood, covered in steel and Azdel, and sealed with closed-cell spray foam insulation, the Camino 88 is solid. The 22-gauge stainless steel roof is one piece with no trim. Rather, it's bent then securely riveted down. Sturdy as it is, it's not boxy. Thermo-pane windows let the outdoor light in, making it feel more open, more natural than many of its truck-camping peers.

With the Camino-88, it's clear: Designers have choices. And all too often, new floorplans just look like a reshuffled deck. KingStar's Camino 88 takes a different path. Each floorplan—there will soon be five—is crafted specifically for different kinds of campers. KingStar designed the Couch/Bunk setup for families, the Lounger for relaxation, the Dinette for friends, and the Open Range for extra room. And now, here comes the Command Center for digital nomads. Each is reimagined for a different type of camper. And each Camino comes customized so that you pick your interior colors, exterior color, and any awesome add-ons that suite your camp style—from skylights and solar packages to pull-out trash cans. Those personal touches KingStar leaves to you.



A Wake Up Like No Other

There's nothing like waking up with the softened light of the morning sun slowly illuminating your room. Turning to the window and seeing nothing but the wild takes you to a place that's hard to describe—except to say it's incredible. The Camino 88 is made to give you that moment again and again. With friendly windows and a large skylight option (shown here), you could quickly forget that you're camping in the back of your truck. When truck camping looks like this, we simply can't get enough.

New Design for Digital Nomads

It's no secret that the remote working scene has exploded over the last three years, enabling thousands—if not millions—of desk-bound workers to choose their own office. So why not work in the Grand Canyon? Or among the Red Rocks of Utah? That's KingStar's thought exactly! The Command Center (coming soon) is carefully crafted for digital nomads, complete with a designated inverter for electronic devices and a file folder cabinet in the center console (and under the seats, too). The layout also maximizes surface area, so your laptop—and work style—is never crowded.

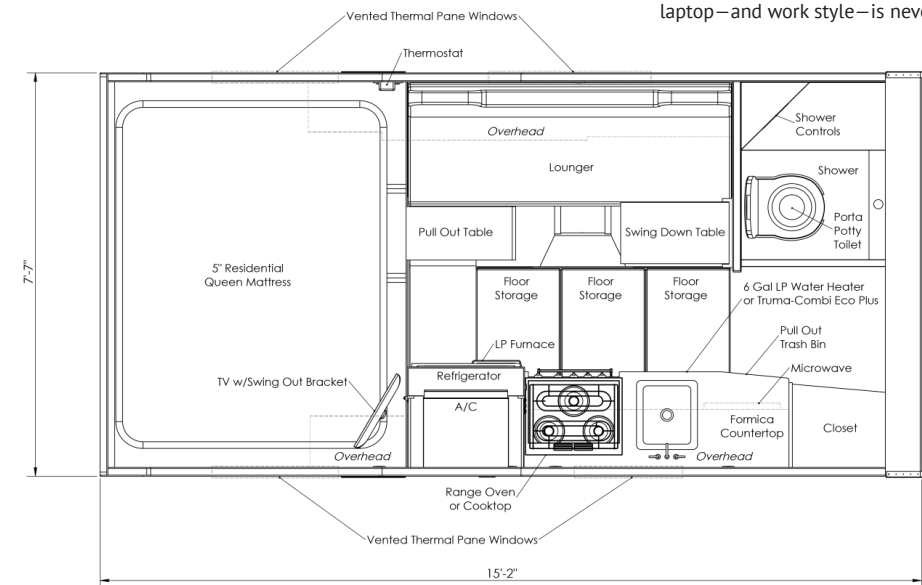

CAMINO 88 LOUNGER FLOORPLAN

▶ BED LENGTHS	6 FT 6 IN OR 8 FT	▶ FRESH/GRAY	32/20 GAL
▶ EXTERIOR FLOOR	9 FT 2 IN	▶ DRY WEIGHT	3,295 LBS
▶ EXTERIOR WIDTH	7 FT 6 IN	▶ CLEARANCE (1T STOCK SUSP)	10 FT 6 IN

Find your truck's perfect bedmate. Shop campers at KingStar.net.

Photos courtesy of KingStar

RV MARKETPLACE

Major RV Innovation
CloZures Shade

Operate without opening the screen or entry door.



Enjoy outside view, control privacy, temp, and light with just a finger slide.

zarcor.com

972-380-8724 | 800-877-4797

SULASTIC RUBBER SPRINGS

SMOOTHER RIDE
by just replacing the shackle

Same payload & towing capabilities

Keeps the ride height in the 1/4" range (unloaded)



www.sulastic.com

(210) 492-4469

ADVERTISE HERE!

Contact Kim Whitaker for ad sizes and rates. Kim@IHeartRVing.com

(919) 412-6325

RELiON Outlaw 1072s
Portable Power Station *By Nate Kennedy*

WE HOOKED IT UP TO THE WORKS, AND THE OUTLAW DIDN'T EVEN BLINK. CLEAN, QUIET, ENERGY EVERYWHERE.

BOTTOM LINE UP FRONT:

→ **PORTABLE POWER IS AN ABSOLUTE MUST** while you're off-the-grid—and as a backup after dark. The RELiON Outlaw handles a heavy load: phones, laptops, tablets—devices that keep your kids happy—and even TVs and refrigerators. It's strong enough to power everything you need to take on adventure, lightweight enough to take anywhere, and unobtrusive without the fumes, noise, or smell of a gas generator. The Outlaw features two AC outlets, three USB-A, two USB-C, two barrel jacks at 12V, a 12V car port plug, and an EC5 30amp DC port. The internal battery management system protects against under/over voltage, over current and short circuits. The pure sine inverter safely powers sensitive devices, and the built-in LCD displays voltage, watts in/out, and remaining run time.

FEATURES WE LOVE:

1,000 W • 2,000 W Peak • 921 Watt Hours
Start up tools or fridges that demand a big initial draw, and keep them running for hours. Then charge your phone. Your laptop. Your friend's phone ... you get the idea.

Good LiFePO4 Chemistry
Lithium iron phosphate means it lasts longer, holds more power, and operates more safely than lithium-ion alternatives. It's cutting edge tech for cutting edge travel.

Over 3,500 Cycles of Life
The Outlaw will be your sidekick through all your adventures, with over 3,500 recharging cycles. That's over nine years of fully draining while recharging every day!

SEE NATE GIVE IT THE FULL HOOKUP.

Watch the full review on our YouTube channel.

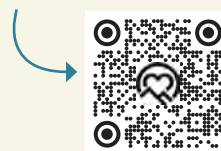

Lightweight and Compact

At just 32 pounds, with a comfortable and convenient carry handle and seriously durable build, you can take it just about anywhere, even if you're not a big lifter.

You know what you need to do. Shop now at RELiONBattery.com.

MSRP: **\$1,099.95**

Photo courtesy RELiON

Firesides

FINAL TOASTS AND LAST ROASTS FOR THE ROAD



Let freedom ring!

One Last Celebration

O SAY, CAN YOU RV!

1 LAST LAUGH
(The Daddest Joke Around)

It's sad that nobody makes RV accessories in America anymore.

The other day I bought a new TV for my rig. It said, "Built in Antenna."

1 FINAL INSPIRATION
(2 Deep Thoughts)

"The freedom of the open road is seductive, serendipitous, and absolutely liberating."
— Aaron Lauritsen, 100 Days Drive: The Great North American Road Trip

See our All-American Road Trips on Page 60.



"The chief benefit of living in an RV is freedom." – Dorothy Ayers Counts, David R. Counts, Over the Next Hill

1 SIMPLE TIP
(Chill Out)

Empty space in your fridge and freezer makes it inefficient. Minimize electricity use and keep your stuff colder for longer when off the grid by filling empty space with water bottles. Just make sure any bottles you put in the freezer have enough space for the ice to expand.

1 BIG TEASE
(Things Are About to Get Wild)

We're looking for great stories from the wild. Hunting. Fishing. Hiking. You name it—and send us your pictures at editorial@IHeartRVing.com!

I FORMAL INVITATION
(Just for You)

Join us on Facebook at @IHeartRVing
Join us on Instagram at @IHeartRVing
Join our email list at IHeartRVing.com
Subscribe to [IHeartRVing](http://IHeartRVing.com) on YouTube

1 CLOSING WORD
(U.S.A! U.S.A! U.S.A!)

Here's a 'Merican-flavored magazine pun for you: We hope you enjoyed this magazine from C1 to shining C4. It's definitely our most patriotic issue ever, which we think makes it one of our best. We think you'll also agree that our country could use more togetherness, and nothing brings people together like forcing them to sit in a small box together for days at a time. What we're saying is, we could all use a lot more RV trips.

In a giving mood? Awesome! Use this QR code to give a buddy a gift they're sure to love.



RV MARKETPLACE



INDOOR RV STORAGE

Located in: Rocky Mount, NC

- Affordable, secure, and insulated facility
- 14' high garage doors fit all RVs, including Class A models
- Next to busiest Amtrak train station in NC for easy access

CALL 914-384-2493
TheBottlingPlantRM.com

CLASSIFIEDS

RVs Wanted



WE BUY YEAR 2015–2022 DIESEL & GAS - CLASS A, B, AND C'S FREE NATIONWIDE PICKUP
TOLL FREE 1-888-782-8987
www.RVBuyersUSA.com
WE WILL BEAT ANY DEALER PRICE

Want to add your business to our classifieds?



Contact Kim Whitaker
Kim@IHeartRVing.com
(919) 412-6325



ACROSS

- 1. To such an extent
- 8. Software program
- 11. "Aladdin" prince
- 14. Bit
- 15. Cheer
- 17. Fine furs
- 18. Surpass
- 19. Haul
- 20. Apple sources
- 21. Abominable Snowman
- 24. City in southern Poland
- 25. Being
- 28. Conductor Koussevitzky
- 32. Pick, with "for"
- 33. Bakery selection
- 34. Sauce thickener
- 34. Cambridge sch.
- 36. Churchyard tree in "Romeo and Juliet"
- 37. Beauty
- 40. Little bird
- 41. Length x width, for a rectangle
- 43. Bickerer in the "Iliad"
- 44. Downed a sub, say
- 45. Having chutzpah
- 47. Good one
- 49. European blackbirds (archaic)
- 51. Chipper
- 52. Violin playing style
- 55. "Rocks"
- 57. A type of engraving
- 58. Pep talk
- 62. Put in office
- 63. Former capital of Kazakhstan
- 64. Dear
- 65. "Comprende"
- 66. Mooched

DOWN

- 1. Anger
- 2. "___ any drop to drink": Coleridge
- 3. Total
- 4. Inflammation of the ear
- 5. A very dry sherry
- 6. Again
- 7. ___ gestae
- 8. Ancient meeting places
- 9. Sculpt eyebrows
- 10. Compassion
- 11. Jewish month
- 12. Do bankers work
- 13. Signs, as a contract
- 16. Sock home
- 20. Tolkien creatures
- 21. A petty officer in a navy
- 22. Run out
- 23. Self-conscious laugh
- 24. Experienced
- 26. "Don't give up!"
- 27. Look at
- 29. Spin
- 30. Instrument of choice for Hendrix
- 31. Scope
- 37. Beauties
- 38. Baseball stat
- 39. Fold, spindle, or mutilate
- 42. Long-legged bird
- 43. Angel accessory
- 46. State flower of New Mexico
- 47. Couch
- 48. Medicinal syrup
- 50. Cook in a little oil
- 52. Berth place
- 53. Durable wood
- 54. Acad.
- 55. Bermuda, e.g.
- 56. Botony term

1	2	3	4	5	6	7		8	9	10		11	12	13
14								15				16		
17								18						
			19					20						
21	22	23				24								
25				26	27				28		29	30	31	
32				33						34				
35				36				37	38	39		40		
41			42					43				44		
45				46		47					48			
			49		50						51			
52	53	54							55	56				
57								58				59	60	61
62								63						
64				65				66						

- 58. Amigo
- 59. "A likely story!"
- 60. Adaptable truck, for short
- 61. Crash site?



Ah, so you have a "friend" who's puzzled over a few answers, huh? Well, tell "them" that we don't mind if "they" check the QR code. Don't mind at all.



			8					9
	1	9			5	8	3	
	4	3		1				7
4			1	5				3
		2	7		4		1	
	8			9		6		
	7				6	3		
	3			7			8	
9		4	5					1



For those whose happy place is just about any place.



Play hard and rest easy in the Momentum series. With its tall ceilings and spacious slide outs, the Momentum has truly raised the bar —and the square footage — when it comes to Toy Haulers. So go ahead, go big — comfortably. *Go where there's more to life.*



MORE OF WHAT MATTERS

Not Just TV. TV Anywhere You Want to Go.

Keep up with your favorite shows while you're on the road.

DISH Outdoors is the **ONLY** premium entertainment solution tailor-made for **ALL RVers!**



SAVE

\$50

ANY DISH
OUTDOORS
BUNDLE

ONLY

**\$5⁰⁰
MO**

FOR EXISTING
DISH
SUBSCRIBERS



- Pay as You Go
- Free Shipping
- No Home Service Required
- No Wifi Or Cell Service Needed!
- No Activation or Disconnect Fees
- No Credit Check



CALL NOW!
855-424-7389

Use promo code: **IHEARTRV**

Visit dishoutdoors.com/iheartrving

dish outdoors