

VANISH INTO THE WILD OVER LAND
AND SEA WITH AN RV FAMILY

SAVE CONSERVE ENERGY WITH
THESE 10 ESSENTIALS

CASH IN AT CALIFORNIA'S PREMIER
CASINO RESORT FOR RVs

I ♥ RVing

2024 RVs

UNCOVER THE MYSTERY

13 THRILLING, NEW
MODELS THAT
WILL HAVE YOU
THINKING UPGRADE

▶ p. 67

+Plus

Spooky, Fun, and Festive
Ideas to Decorate Your RV
for Holidays on the Go



Fall 2023

@IHEARTRVING  
IHEARTRVING.COM





DISCONNECT TO RECONNECT.

Formed out of a desire to build a better RV by building a better RV company, Ember set out to blaze an uncharted path by crafting innovative products backed by an industry-leading warranty, giving every adventure-seeking, memory-chasing owner the confidence to enjoy every mile.

For more information, visit EmberRV.com



Overland Series

Touring Edition



75+

awesome RV stories
dropping each year.

Subscribe to
catch them all!



Get 15% OFF & 1 FREE issue with code SPECIAL15.



Scan the QR code or visit
IHeartRVing.com/Subscribe





RV protection (even with zero cell reception)

Get coverage from a leader in RV insurance.

1-800-PROGRESSIVE / PROGRESSIVE.COM

PROGRESSIVE

Quote in as little as 4 minutes



Progressive Casualty Insurance Co. & affiliates.

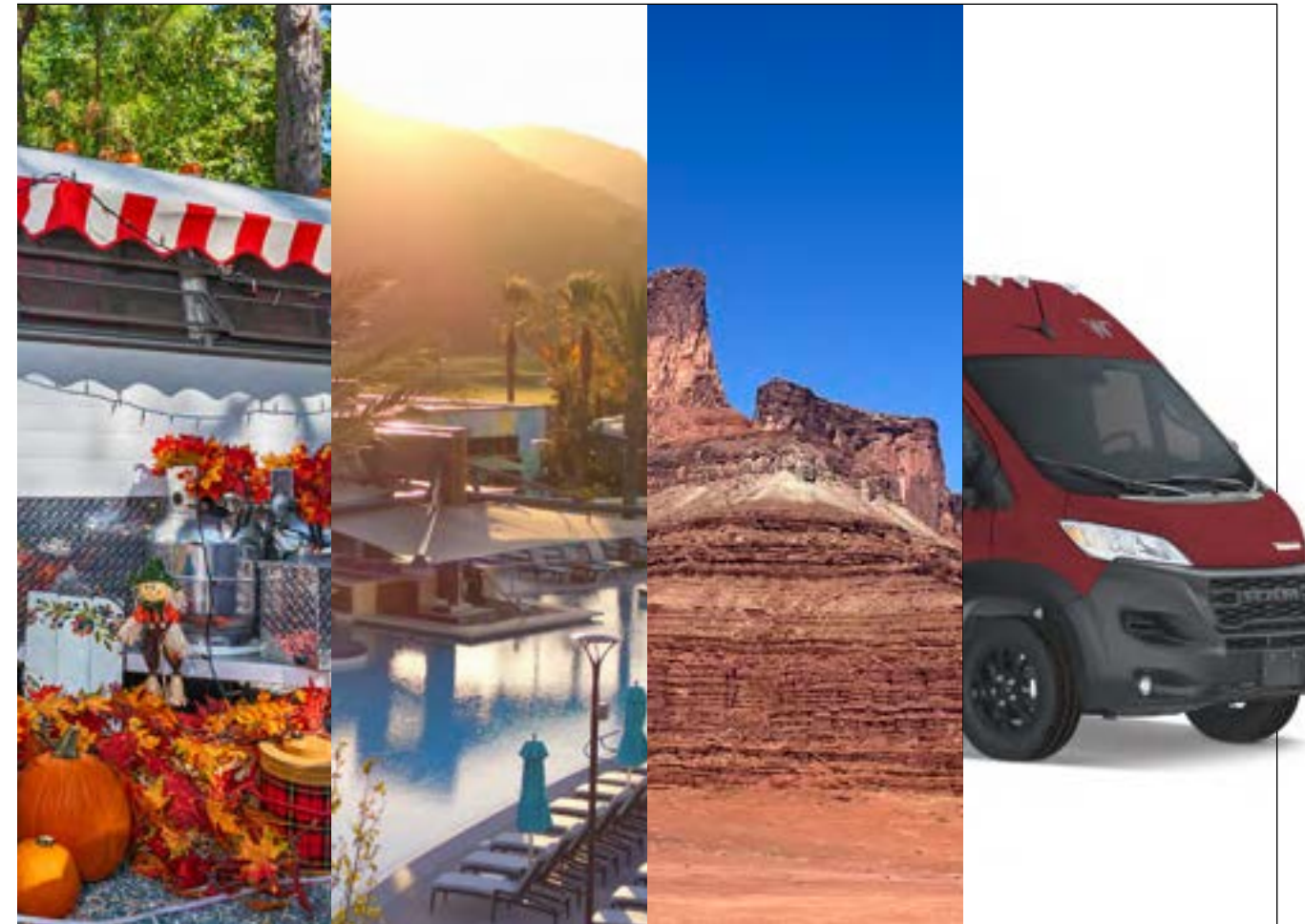

34

Campsite Thrillers for the Holidays

No attic? No problem. Wherever you park your tenement on wheels this holiday season, don't be afraid to go big. From storage starters to cheap tricks, here's a hand guide to give your campsite a festivity-fueled jumpstart.

By Sue Mosebar

48

California's Casino Resort for RVers

The Pechanga Casino RV Resort just might be perfect for RVers. Campsites only minutes from the casino. Premium amenities. Hills filled with golf courses. And, best of all, access to truly unforgettable road trips.

By Mark Settle

56

Nomad Life by Land and by Sea

You might call the Blake family fearless. But you'd be wrong. Rollicking over Utah's red rocks. Sailing across the Gulf of Mexico—all with two young kids in tow. There is indeed fear. But the rewards are worth the risks. Read why.

By Olivia de Soria

67

2024 RVs Pop the Big Question

The industry's newest models have arrived! Uncover ultradeluxe diesel pushers and ultralight trailers. Step into formidable fifth wheels and 4x4 Class Cs. Each will leave you with a question: How do you want to drive into the future?

Departments

7 RV-SHAPED BOX

8 MIRROR CHECK

A Brief Look at the RV News and Community

Catch up on Burning Man's muddy meltdown, play Autumn's smoothest soundtrack, and laugh with the Instagram handle that's making the most of our national parks' worst reviews.

15 AMERICAN VISTA

Vantage Points of American Beauty

Experience an evergreen Autumn under the towering majesty of the Redwood National and State Parks.

23 ROAD ABODE

Improving Life on the Go

- 24 Nomad Internet's Tumultuous Timeline
- 27 11 Eco-Friendly RV Essentials
- 31 A Mobile Beer Garden
- 34 Holiday Decoration Hand Guide

37 EDGE OF THE MAP

From the Highway to the Campground

- 38 A Route Through Utah's Mighty Five
- 41 Save Energy, Save Money
- 45 Craft Beer Campgrounds
- 46 Secret Snowbird Spots
- 48 California's RV Casino Resort

55 RVX

Camping, Adventure, and the RV Experience

- 56 The Heart of a Nomad
- 63 The Butterfly Effect
- 65 Take the Ultimate Test Drive

67 TOP LEVEL

RV Tech and Tradecraft

- 67 First Look at 2024 RVs
- 76 Stargazer Cast-Iron Skillet Review

77 FIRESIDES

Final Toasts and Last Roasts for the Road

- 77 One Last Moment of Zen
- 78 Puzzles

FALL 2023

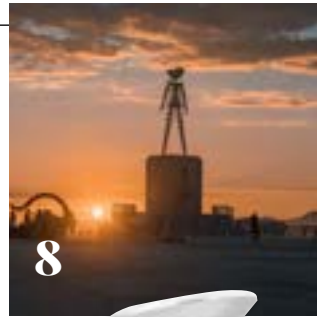

Campground Finder

- 22 Klamath River RV Park, Klamath, CA
- 38 OK RV Park, Moab, UT
- 45 Boulder County Fairgrounds Campground, Longmont, CO
- Bear Creek Lake Park, Lakewood, CO

- Tiger Run Resort, Breckenridge, CO
- Red Mountain Motel & RV Park, Silverton, CO
- 46 Fernwood Resort, Big Sur, CA
- Trinity Bay RV Lodging, Anahuac, TX
- Champions Run, Ocala, FL

- Holden Beach RV Campground, Supply, NC
- 52 Pechanga Casino RV Resort, Temecula, CA
- 59 Goose Island Campground, Moab, UT
- 63 Pismo Coast Village RV Resort, Pismo Beach CA

I♥RVing

I HEART RVING
magazine publisher | **Marc Acton**
managing editor | **Mark Settle**
design director | **Brian Harvat**

sales & partnerships director | **Kim Whitaker**
(kim@iheartrving.com)
integrated media sales | **Laurie Zak**
(laurie@iheartrving.com)
Please contact us to advertise with I Heart RVing

content contributors | **Lindy Cunningham, Liran Federmann, Sue Mosebar, Lana Settle, Olivia de Soria**
product manager | **Brent Noble**
video & social producer | **Nate Kennedy**
social promoter | **Craig Mitchell**
email manager | **Jessica Jiron**
digital marketing specialist | **Larry Norris**
digital media specialist | **Emily Leavens**
developers | **Jason Shores, Ralph Aroljo**
fp&a | **Callip Hall**
intern | **Lilly Petsolt**

I HEART RVING LLC
cofounder | **David Petsolt**
cofounder | **Adam Acosta**

THANK YOU FOR JOINING US AT THE
I HEART RVING GLOBAL CAMPGROUND.
PACK IT IN, PACK IT OUT
EXTINGUISH ALL FIRES
SORRY FOR WHAT I SAID WHEN I
WAS TRYING TO PARK THE RV
PLEASE RECYCLE THIS MAGAZINE
(OR, PREFERABLY, GIVE IT TO A FRIEND!)



FINE PRINT/DISCLAIMERS

Copyright © 2023 by I Heart RVing, LLC

Published by I Heart RVing, LLC. I Heart RVing Magazine was founded in 2021 by a crazy bunch of dreamers, story makers, and idea tree shakers who just want to watch the world read.

I Heart RVing makes every effort to provide information that is informative and practical. The publisher, editor, and writers are not responsible for any adverse outcomes or consequences resulting from the use of suggestions or products that appear in this magazine. The acceptance of advertising in this publication does not constitute or imply endorsement by I Heart RVing, LLC (including parent companies, contributors, affiliates or partners) of any advertised product or service. I Heart RVing accepts no responsibility for claims made in advertisements in this publication.

For all subscription updates and inquiries, go to IHeartRVing.com and submit a Contact form with your details. To subscribe to the magazine, visit IHeartRVing.com/subscribe. To submit a story idea, please contact editorial@IHeartRVing.com.

Next Stop: Nirvana

The RV journey isn't just one across physical landscapes. It's a journey of personal growth. It's an adventure through time and space. And one of the things we love about it is that you can take your journey as far as you want. For some, a weekend trip here and there is enough. For others, the road itself is home. But no matter how far you want to go, our mission is to help you learn, enjoy, and master the life-changing art of the RV lifestyle. So you can go as far as you want.

Now, if life on the road is a never-ending master class (and it is), what does the masters level look like? I think it looks like connection. RVing at its best is communal. Whether you're sharing time with family or friends, trading RV secrets with fellow road warriors, or joining new groups who add to your hub of knowledge, connection always levels up your experience.

There's also doctorate-level RVing. PhD stuff. Like swapping regular routines for rugged self-reliance. Seeking out exhilaration. You know, where you ditch the rut, boondock under strange stars, and conquer new terrain—all with your kids in tow. (Get a glimpse of a family that does just that on Page 56.) The basic idea is built into our RV DNA: Each step that pushes comfortable norms backward also brings fulfillment and adventure forward. Going that extra mile rekindles our wanderlust. New parks, new states, and new RVs—like the 2024 models on Page 67—these are next-level challenges.

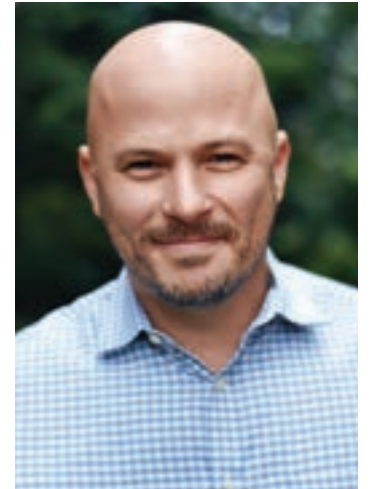

“Beyond your windshield is an uncharted canvas of adventure. RVing can help you reach it.”

And then there's RV enlightenment.

A certain nirvana comes with having enough miles in your side-view that you are one with the road. Each mile behind leads you closer to the place where adventure is just your state of mind. Turns in the road aren't setbacks, but opportunities. Bumps in the road aren't a problem, they're reminders that you're on the road in the first place. If you can reach RV enlightenment, then wherever you go, there you will be... present. Aware. And at peace with the choices that led you to this moment.

Beyond your windshield is an uncharted canvas of adventure. RVing can help you reach it. And I Heart RVing will be with you along the way.

Love ya, mean it.

Marc Acton

Marc Acton
Publisher



IN THE NEWS

Self-Reliance Gets Radical at Burning Man

Burning Man is meant to be a spectacle. The weeklong camp in the playa desert basin outside of Black Rock City, Nevada is an annual festival just before Labor Day where things are meant get weird and wild. But this year, according to CNN, heavy storms dropped two to three months of rainfall on the dry desert lake beds. That's when things got weirder and wilder than ever—trapping over 70,000 burners in an apocalyptic campground caked ankle-deep in mud. For many, the party was over.

Attendees were told to shelter in place, and to conserve food, water, and fuel till the playa dried. Even so, Mad-Max-like convoys trudged through the mud toward the access road, attempting to escape. Some stalled out. The lucky ones raced through rain-made rivers, like Daniel Dumas, an editor for Esquire. Others went on foot across the desert back toward civilization. False rumors spread about an Ebola breakout, according to the Associated Press.

For each and every burner, the festival's very principles—from “radical self-reliance” and “leave no trace” to “communal effort” and “immediacy”—were put to the test. But, given the conditions, an argument could be made that attendees should be graded on a curve.



See footage of Burning Man's radical conditions.



8 RVs Go to Firefighters Who Lost Homes

When massive wildfires hit the Hawaiian island of Maui last August, a national emergency was declared. FEMA and the National Guard were called up. But the toll was tremendous. Over 100 people perished, and more than 2,200 buildings were destroyed leaving thousands of residents homeless, according to CNN. Among the displaced were over 20 Maui firefighters and their families.

So their fellow firefighters in Los Angeles decided to do something.

Working with Emergency RV, a charitable organization that helps provide RVs for victims of national disasters, they were able to help send eight RVs to their fellow firefighters in Maui. Speaking to Colorado Public Radio, Woody Faircloth, who runs Emergency RV, says, “People want to help, they just often don't know how to help.” He notes that the time to act is crucial. “FEMA and the Red Cross swoop in, and they do great work, but it'll take FEMA a full year to get housing units there. That's just too long to wait.” Now, eight families won't have to. The first shipment of five RVs departed on Aug. 23, with the second shipment going out the following week.

Learn more about Emergency RV at EmergencyRV.org.

THOR Partners with Girl Scouts to Pick Up America

THOR Industries is extending its partnership with the Girl Scouts of America through 2025, RV PRO reports. Girl Scouts participating in THOR's Pick Up America Program help remove trash from state parks. Since the program's inception in 2019, Girls Scouts have pledged to remove over 22 tons from public land. But Bob Martin, THOR's president and CEO, sees an even bigger impact for the future: “Providing girls with outdoor experiences which build confident, courageous leaders.”



See how you can create your own eco-friendly space on Page 27.

FMCA Eclipses 60 Years of RV Fun

The Family Motor Coach Association (FMCA) may be big now, as the world's largest not-for-profit association for RV owners. But that wasn't always the case. Sixty years ago last July, a group of 26 families and “house car” owners met in Maine to witness a total solar eclipse.

Bob Richter, a founder member, remembers that night, “It was an experience impossible to describe as we first heard—and then saw—the 26 coaches arriving, one after another, with our new friends. The coaches varied from a simple school bus on its fifth engine with only a mattress,

a crib, and a stove in it, to a lush executive coach costing well into the six figures. What a sight to see them coming up the hill! And what great people!”

Sixty years later, the people are just as great, but FMCA is a lot bigger. Since its founding, FMCA has issued more than 543,000 memberships, touching many lives along the way. And more keep rolling in.

Start a membership of your own at FMCA.com.

An RV Ambulance Hits the Road

Within a one-hour radius of Reading, Pennsylvania, you can call an ambulance—for your RV. And you don't need to dial 911 to do it. According to the *Reading Eagle*, Bill D'Andrea, a master certified RV technician and RV dealership owner with over 40 years of experience, is taking mobile repair calls at RV EMTs. Retrofitting an old ambulance with RV emergency gear, RV EMTs arrive ready to help with electrical, gas, maintenance, plumbing, towing, brake, suspension, and appliance repairs. D'Andrea doesn't book many appointments, ensuring he's available to react when people really need him. He says, “I was going to retire. I did this because I wanted to, not because I had to. I am actually enjoying helping people.”

Driving through Reading, Pennsylvania? Save this number: (484) 978-3687.



Mother Nature's Music

SONGS FOR FREE SPIRITS OF EVERY ERA.



Paolo Nutini, “Autumn”

Sometimes Fall can be a reflective time. Cooler weather and fading colors transport us to cherished memories and people, now gone. And so does this standout track.



Led Zeppelin, “Going to California”

Fresh places and a new starts inspire travel. With the hope of healing old hurts and finding happiness in a new destination, is there a better escape than California? (Make up your own mind on Page 48.)



King Harvest, “Dancing in the Moonlight.”

Who doesn't love the crisp Autumn air and dancing in the moonlight? There's nothing like a little late night fun around the fire with new friends at the campground.



Laura Marling, “Rambling Man”

A young woman reflects on a desire to choose a different path. With beautiful and lilting vocals, Marling's folk ballad inspires us to own the unknown—and take the road less traveled.



Leon Bridges, “River”

There's something spiritual about being in nature. The change the Fall brings, and later, the new life that comes with Spring. Bridges himself said, “A river has historically been used in gospel music as symbolism for change and redemption.”

2023 TREND: CASHING IN ON RV RENT

RV sales have slowed in 2023, according to Yahoo Finance. But RV owners are making some extra moolah with Wallabing, an RV rental company, where they can list their RV for free. This past year, RV Business reports that Wallabing saw a whopping 162.9 percent increase in users and a \$2,500 average for transactions.

162.9%

INCREASE IN WALLABING USERS

\$2.5K

AVERAGE WALLABING TRANSACTION

Album covers courtesy of Spotify. Photo: Shutterstock.com

FIND YOUR INNER FLOWER CHILD



Clearly, you don't have to be a hippie to sing along—or live that van life. (But it doesn't hurt.) Press the by the Mother Nature's Son playlist on Spotify to let the music play.

One Red-Hot Handle

LAUGHING WITH THE RVERS WE LOVE AND FOLLOW ON SOCIAL MEDIA

➔ Look. Not everyone loves everything. Or so Amber Share and her hilarious Instagram handle @SubparParks likes to remind us. Taking real one-star reviews of national parks as her inspiration, she pairs them with her beautiful illustrations. The results? A surefire chuckle. Here are a few of our favorites.

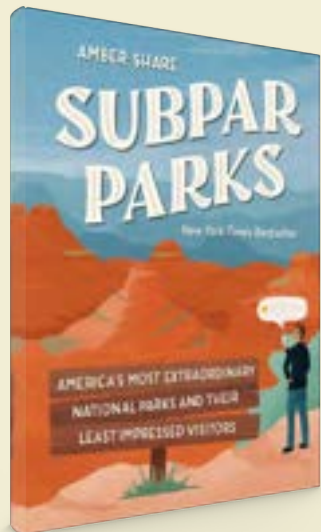

Trust us: There are a lot more LOL in the book. Order yours today.

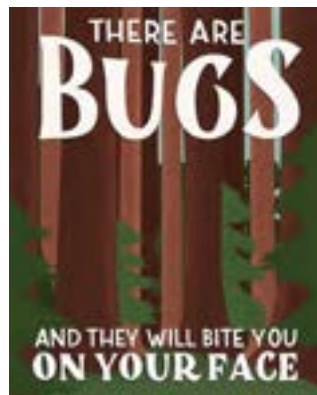

Sequoia National Park



Arches National Park



Great Smoky Mountains National Park



Joshua Tree National Park

Photos courtesy @subparparks

Photos Instagram: @lind_says/@helloamerica/@tifforelie/flvsga

@TIFFORELIE
WHY WE HEART IT
Tiffany shows us how far a few Autumn RV decorations can go. A little pumpkin here. A touch of grain there. Instant atmosphere. (See our own tips on Page 34.)



Scrolling the Virtual Campground

@LIND_SAYS
WHY WE HEART IT
Because Christmas is merry even when it's mobile. And Lindsay's decorations are cute and cozy!



@FLVSGA
WHY WE HEART IT
It's tailgate season! Georgia and Florida fans meet annually at "RV City" in Jacksonville for the World's Largest (Don't Call It A) Cocktail Party. And even the rigs show their spirit.



@HELLOAMERICA
WHY WE HEART IT
Fall is not just about color. It's about the texture of the land. And waking up with cool air in your lungs—and the world's best morning view.



Most Played TikTok

With a bear at his heels, the kid says, "Can we play dead now?" We're losing it!



My 6 yr old as calm as a cucumber. #bearthcounter #hikingwithkids #outdoorsfamily #crazyvideo"

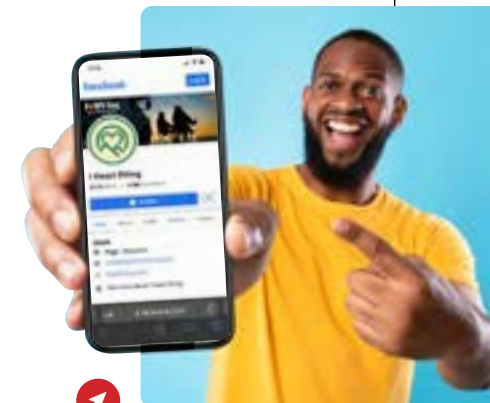

Jump Into the Fun on Social
Find us on social as we share everything RV—including giveaway offers with great brands. We'll save you a spot at @IHeartRVing on Facebook and @IHeartRVing over on Instagram.

SUN CYCLE™ ADVANCED LITHIUM BATTERY

100AH ADVANCED LITHIUM SMART BATTERY

The NEW Sun Cycle® Advanced 12V 100Ah Lithium Battery adds enhanced safety and communication features to our flagship lithium battery line. This lightweight, Bluetooth-enabled LiFePO4 battery has an advanced BMS with a built-in smart DC heater, inter-battery balancing for series batteries, reserve capacity feature and convenient mounting features.

- ✓ Bluetooth®-enabled, smart features and RV-C compatibility
- ✓ Built-in DC heater
- ✓ IP68 waterproof (should not be submerged)
- ✓ Built-In Mounting Options
- ✓ 10-year warranty
- ✓ Improved Battery Management System (BMS) protects against:
 - Over and under voltage
 - Over and under temperature
 - Charge and discharge over current
 - Short circuit



Bluetooth® **RV-C** Compatible

Learn more at
GOPOWERSOLAR.COM/ADVLITHIUM



MIRROR CHECK

RV QUIZ

Fall Tricks, Treats, and Trivia

See how deep your cornucopia of knowledge goes.

No. 1

Leaves change color in the Fall because ...

- A. Less sun means less chlorophyll.
- B. Deciduous roots can't handle frost.
- C. Plants store water to hibernate.
- D. Green just seems out of season.

Answer: A. "Chlorophyll? More like borophyll!" At least for those deciduous trees come Autumn. As their greening agent disappears, a natural color show emerges. But for evergreens, like the majestic redwoods on Page 15, fall remains an emerald city.

No. 2

This college football rivalry is historically played around Halloween weekend?

- A. USC-Notre Dame
- B. Michigan-Ohio State
- C. Georgia-Florida
- D. Virginia Tech-Virginia

Answer: C. Once known as The World's Largest Cocktail Party, the Georgia-Florida game in Jacksonville is played annually around that all-hallowed hinge of October and November. The camper Spaten, and Hofbräuhaus. See how to make your own mobile Biergarten on Page 31.

No. 3

Jack-o'-lanterns were originally carved from turnips.

- A. True.
- B. False.

Answer: A. The Irish invented the jack-o'-lantern. At the time, they carved turnips to keep the wandering soul of Stingy Jack—an Irish legend—away. Today, we've left the turnip—and Stingy Jack—behind for the more familiar pumpkin. Carve out a few holiday decorating tips for your RV on Page 34.

No. 4

Which of these breweries officially qualify for Oktoberfest?

- A. Bud Light, Coors Lite, Millers Lite
- B. Augustiner, Löwenbräu, Spaten
- C. Blue Moon, Shiner, Yuengling
- D. Guinness, Heinkien, Stella Artois

Answer: B. So you figured it out, huh? The German ones. The full list includes six: Augustiner, Hacker-Pschor, Löwenbräu, Paulaner, Spaten, and Hofbräuhaus. See how to make your own mobile Biergarten on Page 31.

No. 5

Visitor numbers drop with the temperature at Zion National Park in late Fall.

- A. True.
- B. False.

Answer: A. Oh, yes. This is what savvy RVers like to call the "sweet spot." The Summer crowds have withered away. Snowbirds are off hugging some shoreline. But clever you? You're experiencing Zion—and all of Utah's Mighty Five—with reduced traffic. (See Page 38)

No. 6

At the first Thanksgiving feast in 1621, what was on the table?

- A. Pumpkins, squashes ... and gourd only knows what else.
- B. Mashed potatoes, turkey, and a river of gravy.
- C. Deer, fish, wildfowl, and cornbread.
- D. A and C.

Answer: D. Our two surviving sources are pretty scarce on specifics. (Deer is clear, but what does "wildfowl" mean? Turkey? Probably, but it could also include ducks, geese, and swan.) Ironically, "gourd only knows what else" is about right. Gourds, beans, cornmeal, fish, and berries were all likely on the table.

No. 7

The smaller "half" of the wishbone is actually considered lucky.

- A. True.
- B. False.

Answer: B. Clearly, it's the bigger half. Anyone who says otherwise is probably still holding the lesser half of a broken bone. But hey! At least you're not arguing about politics.

Don't let a bug bite keep you up all night!



Easy, one-touch application!

- Instant Relief
- Stops Pain Fast
- Stops Itching On Contact
- Relieves Swelling



RELIEF FROM:

- Fire Ants
- Chiggers
- Ticks
- Sand Flies
- Fleas
- Mosquitoes
- Bees
- Wasps

Get relief from bug bite pain and itch with **ChigaRid!**

ChigaRid.com | 214-951-8687





Come see what is NEW at Forest River!

EAST TO WEST 5th Wheels are the fastest growing divisions with a 46% increase in 2023 retail sales per Statistical Surveys, Inc.



TANDARA | BLACKTHORN | AHARA | TAKODA | WWW.EASTTOWESTRV.COM

American Vista

VANTAGE POINTS OF AMERICAN BEAUTY

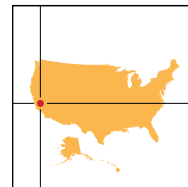

▶ REDWOOD NATIONAL AND STATE PARKS ▶ CALIFORNIA
 ▶ 41°17'12"N, 124°05'25"W ▶ NPS.GOV/REDW



BENEATH THE SHADOWS OF GIANTS

It is normal to feel one's very smallness. Indeed, amid the Redwood National and State Parks, it is easy to imagine the trees being guardians of a sacred place—as the native Yurok did—or as the towering ents that sprung from the fantastical imagination of Tolkien. This land of legendary trees has enormous power to enchant. Covered in evergreen peaks surpassing 300 feet and full of mystic fogs, every moment presents a natural spectacle that awes and captivates. Up its lumbrous middle, U.S. Route 101 runs south to north like a long, paved trunk. And for the adventurous RVer, hundreds of miles of trails branch out into its inexpressible, evergreen, Autumn stillness.

Photo: Shutterstock / Zack Frank



**An Evergreen
Path Through
Fog and Fern.**

Damnation Creek Trail in Del Norte Coast Redwood State Park leads you through dense dens of ferns. Western light combs through pillared trees and pierces the afternoon fog along the elevated 3.4-mile, out-and-back trek. It's open year-round, but its stunning coastal conclusion is currently closed due to bridge repairs.

**Nearest
Parking Lot
Coordinate**

41° 38' 54" N
124° 06' 49" W



**Out of the
Canopy to the
Coast**

Breaking free from the redwoods, take the two-mile Coastal Trail and Yurok Loop in Redwood National Park. You'll trade living towers for open sky, silent old-growth forest for driftwood and crashing waves. Just don't forget your camera.

**Nearest
Parking Lot
Coordinate**

41° 35' 40" N
124° 05' 57" W



**A Creek Walled
in Living
Green.**

The Fern Canyon Loop Trail is one of those miracles of nature that stays with you your whole life. But prepare to get your feet wet, because the creek itself is your trail as you enter the frond-covered walls of Fern Canyon in Prairie Creek Redwood State Park.

**Nearest
Parking Lot
Coordinate**

41° 24' 02" N
124° 03' 56" W



Enjoy an evergreen Autumn under nature's lofty skyscrapers along the California coast.

There are not many places on this planet where you can drive your vehicle through a tree. But one of them—the Tour-Thru Tree—is in the Redwood National and State Parks. (And yes, you might have to unhitch to pull off that little maneuver.) But driving through a living tree that's over 800 years old is only the beginning of the wonders you'll see in this 139,000-acre park complex (one federal and three state). From the southernmost entrance at Thomas H. Kuchel Visitor Center in Orick, you're a half-hour drive away up U.S. Route 101 and Newton B. Drury Scenic Parkway to the only full hookup in the area: Klamath River RV Park. But don't be in a hurry to get there. Detours abound that put you on hiking trails beneath tree-sized limbs filled with white-tailed kites, flying squirrels, and the copper-colored rufous hummingbird. Bears roam these parts. Otters play in these rivers, and sea lions loll across the beaches—all just waiting to be seen.

A GLOWING REVIEW
Amber Share takes subpar reviews of national parks and makes irony an artform. Some of our favorites are on Page 10.

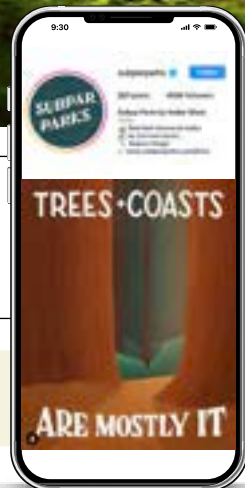

Road Abode

IMPROVING LIFE ON THE GO



INSIDE: Make a mobile biergarten for Oktoberfest! Page 31

Make Your Campsite a Holiday Thriller

NO ATTIC? NO PROBLEM. Wherever you park your tenement on wheels this holiday season, don't be afraid to go big. The holidays are built on atmosphere, and your campsite has plenty of space to create it. From storage starters to cheap tricks, we can give you a jumpstart. Just keep telling yourself, "It's not a competition. It's not a competition. It's not a competition." Then drop the mantra, leap to Page 34, and get prepped to win this thing.

Photo: Pages 16-17: Shutterstock.com / Stephen Maehle / Pages 18-19: Shutterstock.com / Roman Khomyak / Pages 20-21: Shutterstock.com / Zack Frank / Page 22: Shutterstock / Oscity / Karin Hildebrand Lau / 4clips

Photo: Shutterstock / Terry Kelly

Phantom Signal

Tracing the timeline of the alleged Nomad Internet scandal ain't easy. From the company's claims to its RV influencer fallout and the \$75-million lawsuit it's facing in the State of Texas, the truth remains clouded in controversy.

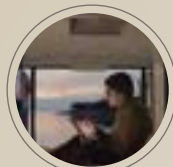

Who is Jaden Garza?

Watch Jason Epperson from RV Miles investigate that question.



1 A Welcome Promise

Fast, reliable internet is not one of the hallmarks of RV life. So when Nomad Internet promised RVers the ability to connect to fast internet anywhere you need it, that sounded like very good news.

JUN 2017

Nomad Internet founded by Jaden Garza with the mission to serve the underserved, bringing people in rural communities and RV parks reliable access to the internet. Source: NomadInternet.com

JUN 2021

Nomad Internet claims a customer base of 20,000. Source: NativeNewsOnline.net

JAN-FEB 2023

Jaden Garza contacts additional RV influencers to endorse Nomad Internet, including the Grateful Glamper and RV Lifestyle YouTube channels. Source: The Grateful Glamper and RV Lifestyle.

JAN 2023

Nomad Internet announces its aim to bring internet service to 60 million rural homes. Source: NomadInternet.com

MAR 2023

The Grateful Glamper publishes endorsement video of Nomad Internet. Source: The Grateful Glamper

3

Complaints & Influencer Fallout

RV influencers begin receiving complaints about Nomad Internet from their followers leading many to withdraw their endorsements. Below are only a few select influencer examples, chosen either for their importance to the timeline or their openness in addressing the topic with their followers.

MAR 12, 2023

Creativity RV withdraws endorsement on YouTube. Source: Creativity RV

APR 6, 2023

Grateful Glamper withdraws endorsement on YouTube. Source: The Grateful Glamper

APR 8, 2023

RV Lifestyle withdraws endorsement on YouTube. Source: RV Lifestyle

APR 14, 2023

State of Texas secures temporary injunction with an asset freeze against Nomad Internet. Source: TexasAttorneyGeneral.gov.

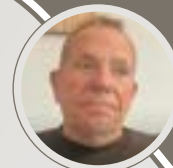

Listen to a Breakup Video

Mike from RV Lifestyle on YouTube shares his story.



APR 21, 2023

Nomad Internet states in a press release that the Texas Attorney General's probe "fails to acknowledge key facts, causing confusion among consumers." Source: NomadInternet.com

4

Massive Legal Action in Texas

The State of Texas files a multimillion dollar lawsuit against Nomad Internet, naming Homero Garza (aka Jaden Garza) as one of three defendants, who allegedly misrepresented the internet company's relationship with wireless internet providers to customers and leased SIM cards prohibited for resale.

MAR 30, 2023

Texas Attorney General Ken Paxton files \$75-million lawsuit against Nomad Internet for violating the Texas Deceptive Trade Practices - Consumer Protection Act. Source: TexasAttorneyGeneral.gov.

2

Waves of Endorsements

Quickly growing behind claims of a partnership with one of the nation's biggest wireless carriers and promises of improved customer service, Nomad Internet seeks RV influencer endorsements. After receiving a trial service package to test the product, many endorse it after determining that the service works.

NOV 2022

Nomad Internet claims partnership with one of the nation's biggest wireless carriers to enhance the speed and reliability of 4G, 5G, and LTE. Source: Finance.Yahoo.com

I'VE SECURED A TEMPORARY INJUNCTION WITH AN ASSET FREEZE AGAINST NOMAD INTERNET TO MAKE SURE THEY CANNOT SCAM ANY MORE UNSUSPECTING CONSUMERS WHO ARE SIMPLY TRYING TO OBTAIN BASIC INTERNET ACCESS.

- Texas Attorney General Ken Paxton



Follow the lawsuit at TexasAttorneyGeneral.gov.

Keep cool in peace.

Don't suffer through a loud A/C. Get an RV A/C silencer!

- Noise reduction
- Better filtration
- Increased air flow
- Simple installation

"It works fantastically. I will be ordering a second one for the back bedroom A/C."

- Rod B., San Diego, CA



Order an RV A/C silencer today!

WackOProducts.com/IHeartRVing



Tank FRESH

Enjoy all the benefits of a

CLEAN WATER TANK

while on the road



clear2o.com

Softer water by design CLEAR2O



Why settle for anything less?

Ask for Truma Combi - The Original on your next RV.



#simplybetter
truma.net



Waste is a word that explains itself—and few places expose it like the RV life. Whether you're a dispersed camper or brand-new gl camper, your proximity to nature prompts a change in perspective. Now, to be sure, what that looks like is a little different for every RVer; but what's certain is that your relationship with nature will have a moral and practical impact on the way you camp. And we think that's pretty cool.

Living a little in the wild (even if it's just for a week-end) reminds us why we make the choices we do—even how we do ... doo. From cleaners and compost to the products we carry along, it all makes a difference for the environment and (equally important) for our ability to live comfortably in nature's most beautiful parking spots.

So, here are a few eco-friendly essentials that stay evergreen season after season.



Keep Fresh and Clean-Clean

Better water supply and nature-conscious cleaning.

CLEAR2O TankFRESH Water Tank & System Flush

GET FRESH. NO CHLORINE OR BLEACH REQUIRED. Fresh water is the wellspring of human life. No one knows this better than a camper, because your supply is finite—especially when you're parked far beyond the reach of a full hookup (see Page 45). You need your fresh water to actually be fresh. That precludes weird chemical smells and foul tastes. CLEAR2O TankFRESH is chlorine-free, contains no bleach, and eliminates any olfactory offenders left lurking in your freshwater tank. One gallon treats 100 gallons of capacity, and makes sure that your water is safe, drinkable, and nature-friendly.

Buy at CLEAR2O.com, \$34.99. (1 gallon)



Gabe's Pride Everyday Essentials Cleaning Kit

ENVIRONMENTALLY RESPONSIBLE CLEANERS. Your RV's lack of square footage means every inch gets a lot of traffic. So you need a tough cleaner. But man! Most tough cleaners are full-on chemical factories. Standard cleaners are hard on your hands, rough on your lungs, and burning with harsh chemicals that you don't want to fill your cabin with. Gabe's Pride solves all that with environmentally responsible cleaners and commercial grade cleaning tools that make cleaning easy and effective and charmingly fresh. (Their fragrances are even California Prop 65 compliant.) The Everyday Essentials Cleaning Kit gives you the basics to master your entire interior with a multisurface, bathroom, and RV window cleaner, plus microfiber cloths and a shower track/grout brush.

Buy at GabesPride.com, \$42.00



All Seasons Indoor Composter Starter Kit

KEEPING FOOD WASTE OUT OF THE LANDFILL. There are levels of composting. (And no one knows which level is right for you better than ... well ... you.) But it feels safe to say that we are all left with food scraps—whether that's from cooking in the galley or those fainting remains of old takeout. Just composting those basics can keep unnecessary food waste away from our overfilled landfills. And, if you've got a green thumb going at your campsite, you can nurture your plants with easy-to-access compost tea. Do it all in a bin that takes up just one square foot of space.

Buy at Amazon.com, \$72.95



Camco RV Pop-Up Recycle Container

YOUR INSTANT RECYCLING BIN. Nature's best parking spots don't usually have a recycling bin next to them. Unless you bring yours. Fortunately, the Camco RV Pop-Up Recycle Container makes it easy. Like super easy. It folds down to 2.5 inches tall, so you can store it almost anywhere. And once it pops up, it has dividers for paper, cans, and bottles—which could come in handy if you're planning a mobile Oktoberfest (Page 31).

Buy at CamcoOutdoors.com, \$19.99



Get Down to Business

The bottom line from the bowl to the black tank.

Hinlo Bowl Flushable Toilet Liners

EXPERIENCE A CLEANER TOUCHDOWN. Hinlo Bowl solves two big No. 2 issues: poop stains and splash-back (aka The Kiss of Poseidon). These flushable toilet bowl liners are eco-friendly, biodegradable, and dissolvable. Just place one inside your toilet bowl before you do your business. Then afterwards, flush. It's funny to say, but(t) it's true: Removing poop stains saves water. It prevents multiple flushes and save you from spending money on cleaners.

Buy at HinloBowl.com, \$9.99



Thetford Porta Potti 365

A COMPACT COMPOSTING TOILET. There are lot of great composting toilets out there, all depending on how much you want to spend. The Thetford Porta Potti 365 is a great fit for a lot of reasons: price (it's low), size (fits nicely in a tight space), and ease (for cleaning in a pinch). There are other obvious benefits, too. Saving lots of water is one. The ability to relax in nature when it calls is another.

Buy at Amazon.com, \$157.99



Valterra Odorlos Holding Tank Treatment

100 PERCENT BIODEGRADABLE AND CALIFORNIA FRIENDLY. Nontoxic and formaldehyde-free, Odorlos has the added benefit of being California compliant. Which is big when you're looking for a full hookup near the Redwoods National Park (Page 15) or planning a foray into Southern California's golden autumn (Page 48). Odorlos is 100 percent biodegradable and accelerates the breakdown of tissue and waste, providing naturally occurring bacteria with a continuous supply of the best alternative energy source to pure oxygen—nitrates. But the best part might be the smell: There is none.

Buy at Amazon.com, \$28.98. (168-oz. bottle)



Photos courtesy of their respective manufacturers

Magne Screen

by Hunckler Fabrication LLC

A NEW PRODUCT BY **Magne Shade**

Magne Screen™ is the exclusive magnetic awning drop shade for automatic awnings.

Magne Shade

by Hunckler Fabrication LLC

MagneShade.com
336-753-0905

Monochem Dyna-Bact Deodorizing Packets

NATURAL TOILET SMELL SAVIORS. Bathroom solutions always sound sticky. But Dyna-Bact has an easy one: If your toilet is stinking up the cabin, toss in a packet and flush. Still, the packet does more than mask an unholy odor. Dyna-Bact digests residue inside of the holding tank, cleans waste from tank walls, and reduces environmental contamination. How does it do it? With a super science-y combo of bacteria and enzymes that work together to smell good.

Buy at Walmart.com, \$15.51



Wonder what you can compost? Watch this and wonder no more.





Alaska state ferries journey through spectacular waterways that offer breathtaking natural beauty and abundant wildlife. Alaska is incredibly unique; experience it more by traveling off road.

ALASKA MARINE HIGHWAY

FerryAlaska.com | 1-800-642-0066

f y i #alaskamarinehighway



Go Shamelessly All-Natural

Materials that make a difference.

Foodle

Wheat Straw Dinnerware

SUSTAINABLE DINNERWARE—EVER YOU GO. Styrofoam and plastics are some of the worst campsite culprits. Their literal presence can all but sour a perfect spot. Far better to keep a small sustainable set of camping dishes like Foodle Wheat Straw Dinnerware. Stylish and stackable. Light and microwavable. You can kiss Styrofoam—and all its neurotoxins—goodbye.

Buy at Amazon.com, \$36.99



7 Principles of Leave No Trace

Eco-friendly products are only part of our nature-loving equation.

- Plan Ahead and Prepare
- Travel and Camp on Durable Surfaces
- Dispose of Waste Properly
- Leave What You Find
- Minimize Campfire Impacts
- Respect Wildlife
- Be Considerate of Other Visitors



Bee's Wrap

Beeswax Wraps

PLASTIC WRAP REPLACEMENT.

As RVers, we love finding new, innovative ways to do things. And this sustainable replacement for plastic is one of our favorites. Made from organic cotton, beeswax, plant oil, and tree resin, Bee's Wrap is a durable yet pliable food wrap that can be used over and over. Unlike plastic, it breaks down in compost. But it shines most in use. Prepping for picnics. Saving leftovers for later. Bee's Wrap keeps it all fresh, while cutting down your plastics.

Buy at BeesWrap.com, \$24.99 (Roll)



Wilderness

RV Mattress

MADE FOR RVs. CERTIFIED FOR THE ENVIRONMENT.

Specially designed for RVs, these mattresses are engineered to better regulate temperature and layered to give comfort not normally found in foam beds. They also all carry a CertiPUR-US® certification. That means that each has undergone rigorous testing and an evaluation to meet specific environmental, health, and safety standards. So, no harmful chemicals or ozone depleters. Low volatile organic compound (VOC) emissions. And the assurance of eco-friendly manufacturing. All so you can sleep better at night.

Buy at WildernessRVMattress.com, \$393.00–\$855.00



Looking for ways to cut your energy? Jump to Page 41 next. >>>



Ein Über RV Biergarten

Turn your campsite into a tiny Wiesn this Oktoberfest.

by Marc Acton

In 1810, while Napoleon was driving his empire across Europe, and Beethoven was composing “Für Elise,” Bavarian royalty was inviting the citizens of Munich to a big wedding bash for the Crown Prince. And what a bash it was.

Today, 204 years later, the party is still raging. Munich still breaks out the lederhosen yearly. About 7.5 million gallons of beer are consumed by around 6 million people, according to organizers. And millions more around the world join the party.

Oktoberfest is different things to different people worldwide. For some, it's a community-based celebration like Halloween—an excuse to get together with your neighborhood, with live music, food, and a fair-like atmosphere. For others, it's more like a big New Year's Eve social. But for nearly all, it's a celebration of Fall and a great excuse to enjoy time with friends. And you don't have to camp in Germany to enjoy it.

Here's how to make your next parking spot a mobile biergarten. That way, everyone camping around you can join in and feel a little Oktoberfest Freude.

Enjoy an Official Oktoberfest Beer

➔ Only beers brewed by the six breweries in Munich can call themselves officially sanctioned Oktoberfest beers.

The official brews tend to be higher gravity, usually 6 to 6.5 percent alcohol by volume (ABV), brewed with a mix of Pilsner, Vienna, and Munich malts. In Munich, they'll call it a

Märzenbier (a darker malty brew) or Festbier (a lighter, hoppier version). American breweries large and small put out Oktoberfest varietals for the season—which officially starts in September. American versions skew sweeter and lower gravity, but typically use German ingredients.



Photo: Shutterstock.com/ LightField Studios/ jfong

But—as much as we love Sam Adams Oktoberfest—do yourself an authentic favor and find one of the six official brews: Augustiner, Hacker-Pschorr, Hofbräu, Löwenbräu, Paulaner, and Spaten—with Hofbräu and Paulaner being the most common.

To drink it the official way, you'll need a stein, or humper, as they're called in Munich. Originally, a stein was made from earthenware or stone (hence the name), but now the humpers are often thick glass or pewter adorned with designs celebrating German lore, and holding either a half or full liter. Fortunately, you don't have to fly to Munich to get the real thing, as the official Stein is available for purchase online.

If you want to do it right (and why wouldn't you?), do break out the lederhosen. The sturdy leather pants (literal translation would be leather trousers) are still worn by regular folks in Bavaria from time to time. These might be compared to overalls—regional clothing that originated as a functional item for mountain folks, but have been co-opted for other purposes.

Lastly, assuming your local alcohol restrictions allow it, enjoy your celebration outside in the spirit of the real Fest. More importantly, embrace the tradition of community engagement and invite a friend or 10 to join your mobile Biergarten.



Beer-Braised Brats and Onions

→ Sure, brats are a little on the nose, but nothing says, “We love Germany” like a beer and sausage party. Braising typically makes for easier cleanup than frying, and this recipe requires only a few ingredients to crank out maximum flavor, which is always RV-friendly. The braising breaks down the sausage casing and the proteins in the sausage, leaving an easy-to-eat texture. And just like using wine reductions in cooking, the beer braise also adds an even easier-to-love complexity of flavor that will make any ol' brat downright leker (delicious).

Also like wine, cooking with beer removes all alcohol, so you won't need to worry about pregnant or teetotaling guests. You might think of using beer in cooking like a soy sauce, which is another fermented product that adds umami by the bucketful, or even vinegar, which is almost inedible on its own. In other words, even if you don't love the taste of beer, this recipe is still worth a try.

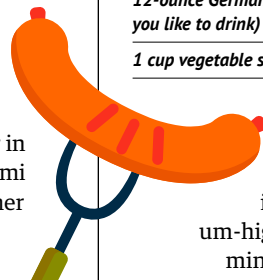

Ingredients

- 1 tablespoon olive oil*
- 1 tablespoon salted butter*
- One package of 6-8 raw brats*
- 1 tablespoon fresh thyme*
- 1 tablespoon honey*
- 1 teaspoon salt and pepper*
- 3 medium sweet onions*
- 1 teaspoon smoked paprika (optional)*
- 12-ounce German Oktoberfest lager (or, cook with what you like to drink)*
- 1 cup vegetable stock*

Brown at least two sides of your brats in oil in a frying pan on medium-high heat, about one to two minutes per side. Remove from the pan.

Add butter, then add onions when fully melted. When onions are sizzling, add all ingredients except for liquids. Stir well, and sauté until onions are softening, about seven minutes. Avoid over-stirring so that some onions can get extra caramelized.

Add beer and stock, and stir again to loosen any crisped or browned bits from the pan. Return brats to pan, ensuring they're all or mostly covered with liquid. Braise for 20-25 minutes, or until your sauce is reduced and your brats have reached 160 degrees F.

Serve whole or sliced, in a bun, over rice, or with a side of potatoes.



Photo: Shutterstock.com/Physoonarth



German Potato Salad

→ Both meat and potatoes are hard-working, effective performers, just like the German people. So a classic Kartoffelsalat will round out your mini-Oktoberfest celebration perfectly. It's one of my favorite side items because it's so customizable to your own family's particular tastes. A little more of this and a little less of that, and you can please almost all of the people all of the time. Plus, it gets RV bonus points for being makeable far in advance of your RV Oktoberfest Extravaganza.

German potato salad is typically served warm, but the other great thing about cooking is that you get to do what you want. I want to serve mine cold, so I do, and no Germans have protested to me yet. Use Yukon gold-style potatoes to replicate the German potato varieties. And pick the highest-quality stock that you can find to use—since you'll be using it straight up, your end product will be at the mercy of its quality.



Ingredients

- 2 pounds Yukon Gold potatoes*
- 1/2 teaspoon salt*
- 1 cup finely minced yellow onion*
- Freshly ground black pepper to taste*
- 3/4 cup high-quality bone broth stock—heated to very warm*
- 3 tablespoons light vegetable oil*
- 1/4 cup white wine vinegar (or mayonaise if you prefer)*
- Medium-chopped parsley*
- Healthy handful of leftover bacon, crumbled*

Scrub and boil potatoes with peels on in salted water until tender, typically 12 minutes. Avoid overboiling, so that potatoes are forkably soft but not falling apart.

As soon as you can handle them, peel potatoes with a paring knife while still hot. (This allows for maximum absorption of flavor into the potatoes for the next step.) Then dice or slice, and place in a large bowl. Pour very warm bone broth over the potatoes, season with salt and pepper, and add finely minced yellow onion and vinegar. Stir until fully mixed, then cover and allow to marinate for at least 30 minutes.

For the full German experience, add oil, parsley, and bacon, mix, and serve warm, with an air of superiority. Or refrigerate and serve. You're der Küchenchef, after all! You should get to Tun whatever you Wallen.

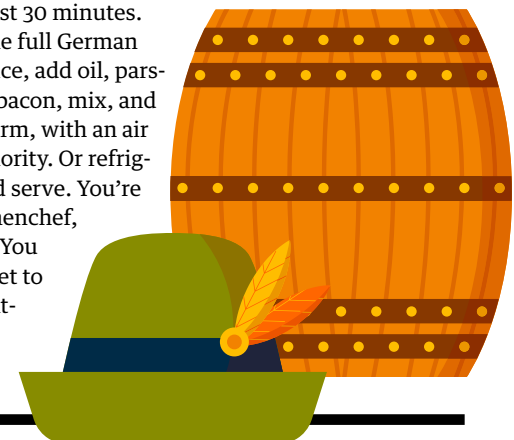

YOUR MOBILE HOLIDAY HAND GUIDE

by Sue Mosebar

SPOOKY, FUN, AND FESTIVE IDEAS TO DECORATE YOUR RV FOR HOLIDAYS ON THE GO.

The holidays make our memories glow. And when we take to the road over the holiday season, we don't want to leave all that in the past. The traditions, the decorations, and the mood all matter wherever we are. We want to take it forward. And yet, we do have to face a fact: We've left the attic—that busy, chaotic, junk-filled attic—with all its storage space behind. (Just saying that, though, does feel pretty good.) That fact alone means that our cargo capacity for holiday decoration is pretty limited. But don't be deterred! Your home on the road can be just as festive as any house in the neighborhood. (Looking at you, Griswalds!) All it takes is some creativity, which—fortunately for you—you have in spades.

So let's talk about the two things you must master: logistics and atmosphere. If you get those down, even your small space can make wonderful new memories.

SORTING OUT A FEW RV BASICS

YOUR STORAGE STARTER. For part-timers with attics and garages, this might be a nonissue. But it's big for full-timers. Avoid getting overwhelmed: Start with one box and imagine that's all you get (for now anyway). What items will make the biggest impact? Go for atmosphere. The holidays are super sensory, so think in terms of lighting, bursts of color, and images. Remember, the box isn't everything. It's your starter kit.

CHEAP TRICKS. You can get a lot of holiday decorations for cheap at Dollar Tree. And charities and secondhand shops often give stuff away. (You can even donate them back when you're done.) It's a great way to fill gaps while avoiding adding more permanent stuff to your RV (see Page 41). And don't forget: Some of the best décor comes from nature itself (more on that in a sec).

Now, let's talk about ideas for the fun part: creating an atmosphere.

TRICK OR TREAT CREATE A CAMPGROUND THRILLER

ERECT EERIE LIGHTING. Nothing quite creates atmosphere like lights. And you don't need a lot for Halloween. (In fact, less is more, because you don't want it too bright) A simple spool of orange rope lights with command hooks can frame windows, outline a sidewall, and give an entrance an eerie pulse. Also, don't discount the effect of keeping a fire pit burning just outside. On Halloween, you can also swap in a few black lights inside your cabin to give trick or treaters a little extra thrill when the door opens.

EMBRACE THE PUMPKIN. Jack-o'-lanterns have been making an impression since their earliest days in Ireland (see Page 13). But for RVs, they're really perfect. Pumpkins are affordable and temporary. Carving them is half the fun, and their firelit eyes animate your campsite with a watchful feeling.

COBWEB IT UP. This décor is cheap, cheap, cheap, and easy, easy, easy. Dimly seen under the orange shadow of your camper, its effect is bigger than the price.

WHAT'S THAT SOUND?

If your RV has an outdoor sound system, use it. You can stream tracks with wolf howls, creaky doors, cat screams, or—what everyone really wants—"Thriller" or "Monster Mash" playing on loop.

SEASON OF HARVEST THANKSGIVING FOR THE MODERN PILGRIM

USE NATURE'S BOUNTY. Stop by a pumpkin farm and pick out a few small gourds or pumpkins, dried corn or leaves, and fresh apples to decorate for Fall. You can use some indoors and others outside. You might even pick up a few straw bales to sit on under your awning. Organic decorations can be easily disposed of (even composted) at the end of the season.

SPREAD A TABLE.

Throw up a table one evening—or use the picnic table if your campsite has one—and create a communal spread for anyone who walks by. The best things are easy: hot cider, hot chocolate, a pot of chili, a bowl full of apples, a cooler of soda or beer. When folks walk by, invite them to eat, drink, and chat with you.

SWAP IN AUTUMN ACCENTS. Inside your cabin, a little bit goes a long way. Choose just one or two throws that can be changed every season. Better yet, use throw pillow covers instead, which are easily changed and take up almost no storage space. With your organic decorations, the accent pillows will really pop—whether they're Fall colors, leaf-patterned, or flannel.

MAKE IT SMELL LIKE FALL. There are two paths here. If you have a screen, let that Autumn air in. Or just light a Fall-scented candle, so the cabin smells like a bonfire or an apple pie.



Photos: Shutterstock/ Ground Picture/Romolo Taveni/ Dr.Pixel/Chinnapong/ Vitalina Rybakova/ JeniFoto



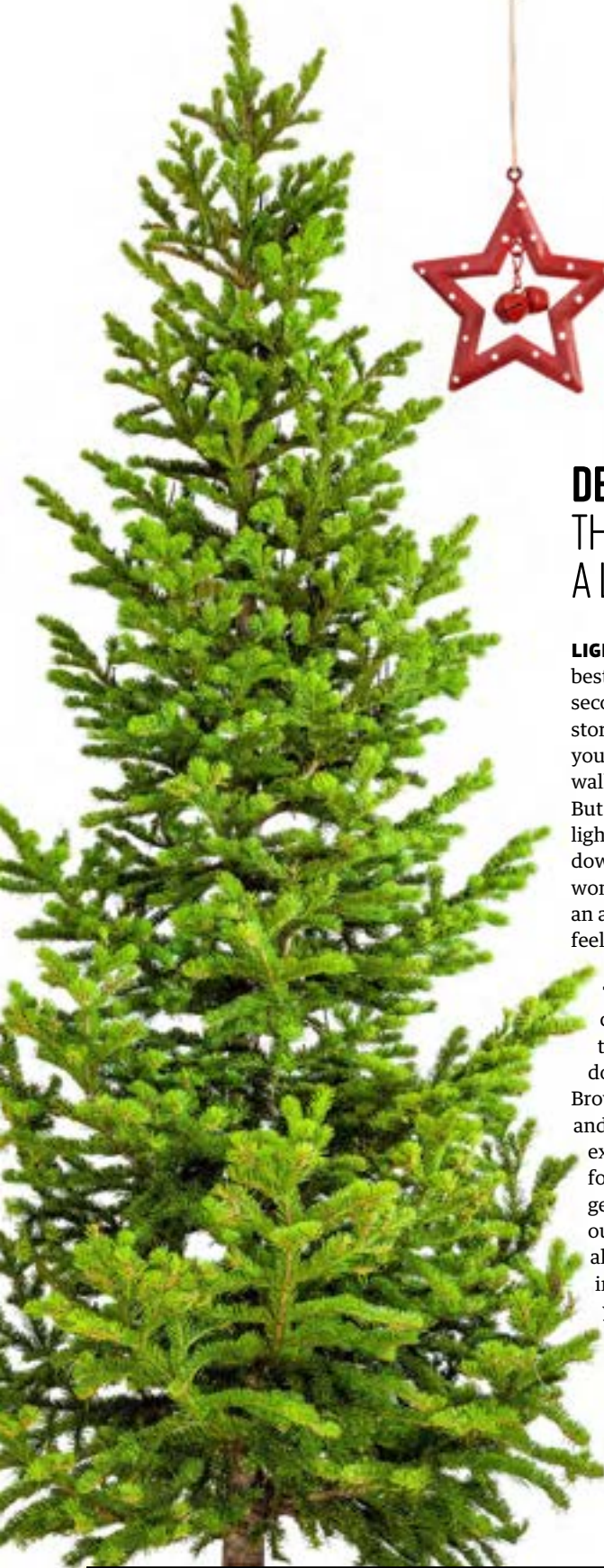

DECK THE CAMPSITE THIS RV'S BEGINNING TO LOOK A LOT LIKE CHRISTMAS

LIGHT. IT. UP. This is one of the best items to hunt for at charities, secondhand shops, and discount stores. (Because you don't want your passthrough storage to be wall to wall with Christmas lights.) But hunt well. Whether it's icicle lights on the inside of your windows (classy) or a merry multicolor wonderland (warm and cozy), get an arrangement that makes you feel most at home—and go for it.

TRIM THE TREE. Inside your cabin, you'll need a slimmer tree to conserve space. But it doesn't have to look like Charlie Brown's. Still, load it up with lights and ornaments to make it feel extra merry. If you're staying for a while at your campsite, get a real tree and place it outside your camper for all to see. You can even invite others to help you decorate it. (And yes, if you're in the

Southwest, you may decorate a cactus for fun, so long as you put a Santa hat on top.)

MAKE IT SPECIAL. Christmas decorations make a space feel cozy. And few Christmas decorations are as versatile as garlands. They also take up very little space, in or out of storage. Cloth and ribbon are also inexpensive and fun ways to create atmosphere without having every surface covered. (Now is also the time to swap in your other pillow covers for the couch.) But remember, you've been saving space for a reason: to have room for those very special items (in your box) that connect all your old Christmas memories to this one.

FILL THE AIR. Whether you're inside the cabin or out under the awning, let Christmas music fill the air—from "O Holy Night" and "White Christmas" to "Jingle Bell Rock!" 🎄



Photos: Shutterstock/jingka/Muzhik/WilleeCole Photography

EDGE OF THE MAP

FROM THE HIGHWAY TO THE CAMPGROUND

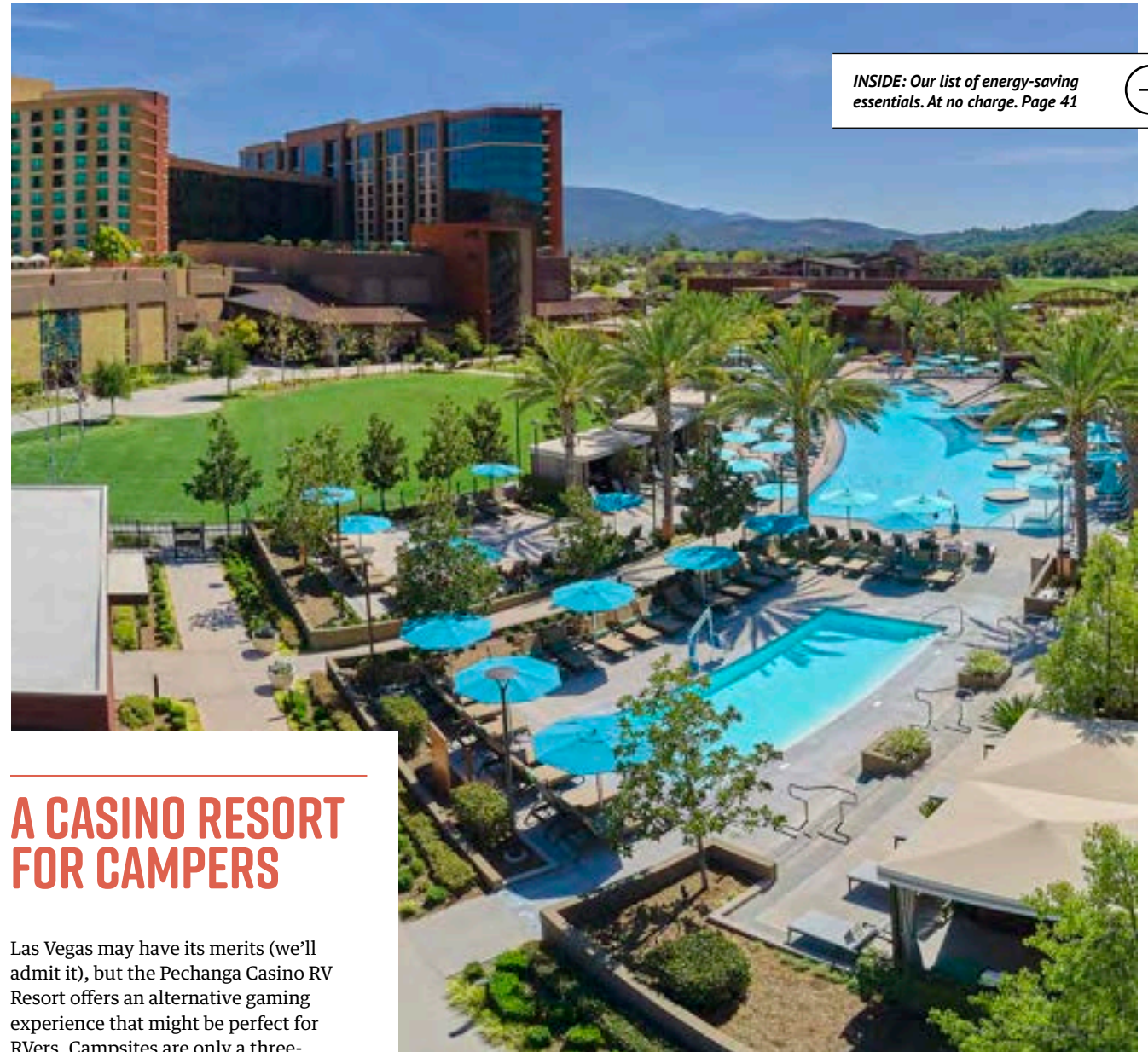

INSIDE: Our list of energy-saving essentials. At no charge. Page 41



A CASINO RESORT FOR CAMPERS

Las Vegas may have its merits (we'll admit it), but the Pechanga Casino RV Resort offers an alternative gaming experience that might be perfect for RVers. Campsites are only a three-minute walk from its 200,000-square-foot playground—and that's just the beginning. There are premium amenities. Hills filled with championship golf courses and covered California vineyards. Then there's its access to unforgettable Autumn road trips.

Photo courtesy of Pechanga Casino RV Resort

	▶ PECHANGA CASINO RV RESORT	▶ TEMECULA, CA
	▶ 33°27'22"N, 117°6'24"W	▶ PECHANGA.COM

Let Science Spark Kiddo Curiosity

Right before kicking off your trip, you want the kids to be pumped! So, while you're near SLC, devote a morning or afternoon to the Loveland Living Planet Aquarium in Draper. Before you coop them up in the cabin, they can explore ocean life, watch penguins, touch stingrays, and sprint across a massive playground. So everyone is having fun from the get-go.

Flying J, I-15 Exit 222
1597 S Main
Nephi, UT 84648

Flying J, I-15 Exit 112
653 W 1400 N
Beaver, UT 84713

Zion National Park

Bryce Canyon National Park

Kiva Koffeehouse
7144 UT-12
Escalante, UT 84726
(435) 826-4550

Capital Reef National Park

Canyonland National Park

Arches National Park

Find Moab's Other Worlds

For decades, Moab's arresting landscape has been the stage for some of film's most otherworldly scenes—from John Wayne Westerns to desert planets in Star Trek. We were so enthralled with it that we explored its rich cinematic history in one of our favorite features.

Scan the QR and read all about it—and the OK RV Park!



OK RV Park
3310 Spanish Valley Dr
Moab, UT 84532
(435) 259-1400
OKRVPark.com

A Cup of Joe and Helluva View

Just up a dirt drive and tucked into the land itself, Kiva Koffeehouse is an easy place to miss. But don't. This rustic café is incredible—from the pillars of Ponderosa pine and wide-open vistas to its house-made tamales and eye-opening cappuccinos. Finding places like this is half the joy of RVing.

Romping Through Utah's Mighty Five

Blue skies. Red dirt. And adventure around every weird rock formation. Take your RV on a road trip of a lifetime.

UTAH IS SOMETHING OF A FREAK SHOW in geologic terms. And it has the national parks to prove it. It's Mighty Five are the nearest thing to a royal flush that nature's dealt any state. There are Zion's slot canyons, Bryce Canyon's haunting hoodoos, and Capitol Reef's red rock cathedrals. It's very nearly art. Every turn at Arches looks like it was dreamt by Salvador Dali. Canyonland's banded sandstone is a watercolor centuries in the making. So, yeah, Utah was dealt a pretty good hand. The question is: Do you know how to play it? Because, with the cooler Fall weather moving in, now is your time.

Consider Salt Lake City, Las Vegas, and Denver your best starting points. But our preference is SLC. Starting your journey next to the science-fiction surface of the continent's strangest lake seems right to us. Frankly, it's a tone-setter for everything you're about to see from your RV—and never forget. You can always make that move toward Vegas—or better yet, toward Pechanga (Page 48)—when you're ready to wipe the red dirt off.

The Road Itself Is Worth the Trip

Everyone and their white-haired mama talks about going off-roading in Utah. (And, by the way, we're all for that.) But don't be fooled into thinking that you need to go off-road to absorb the shock of Utah's arresting visuals. You'll see plenty of jaw-dropping landscape from the hardball.

Rolling south from Salt Lake City on Interstate 15, you can relax and take in the view. You're on the longest, cleanest stretch of highway that you'll encounter the whole trip. All 269 miles of it as you make that first big push toward Zion National Park. You're descending on the western side of the mighty Wasatch Range that cuts North-South down the state. From your windshield, you will see giants. The triple-headed behemoth of Mount Nebo glowers over traffic in Nephi, and Nebo is just one among many along the way.

At Zion—like all the Mighty Five—you could spend ages and never see enough. But if you're squeezing the trip into Fall break, spend about a day at each national park. Here, the northeastern leg of your route winds its way up UT-20 E and UT-12 E to Bryce Canyon in less than two hours. From there, Capitol Reef is another two hours up UT-12 E and UT-24 E. When you're ready to move toward Moab, you'll head up UT-24 E onto I-70 and then down US-191 at Exit 182—with your finish line right by Arches and Canyonlands.

Prepare for Some Park Entry Fees

Wow. I feel like I heard that sigh. (Oh, wait. That was me.) Collectively, all five park entry fees will cost about \$150. So save yourself the \$70 and get the America the Beautiful Pass for \$80 at the first park entrance you hit. You'll be golden from then on.

MAP KEY



Educational Adventure for Kids



RV-Friendly Gas Stations



RV Service Center



Special Chow



TENTSILE®

PORTABLE, VERSATILE, FUN

Our award-winning portable treehouses provide increased separation from insects, snakes and predators, while suspending campers comfortably above wet, rough or muddy terrain, creating a comfortable camp for all seasons.

Use code: **iheartrving10**
For 10% off at checkout

20 Trees Planted

WWW.TENTSILE.COM



Photo: Shutterstock/ David Pereira



Energy Savers You Can Count On

10 ESSENTIALS TO MAKE ENERGY MATH WORK FOR YOUR WALLET—AND THE ENVIRONMENT.

Ever have nightmares involving a big math exam that you didn't study for? (Asking for a friend.) Well, fortunately, when you wake up, you take a deep breath and realize that high school is over. Your acne is gone. And Algebra II is just a bad dream.

But. Maybe that quotient isn't so clean.

Truth be told, a remainder of math still haunts us in the RV life. All the appliances we want to take

and use on the road—that seem like no big deal when we're plugged into shore power—can add up at the campsite. Especially when you're boondocking or a few nights away from your next full hookup.

Fortunately, the solution is to focus on something simple: your energy bill. Because that's where you really want to see some subtraction. So, here are ten essentials to start making that happen and getting your stress to zero.

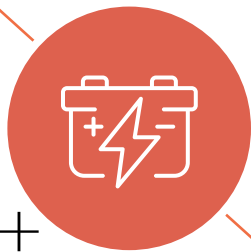

Addition + Retention

Increasing—and keeping—your power.

FACTOR IN THE YELLOW STAR POWER AT THE SPEED OF LIGHT

Whether you're going green or just looking for a renewable power backup, solar is a clear choice. We'll talk a little more in a sec about the symbiotic, power-saving relationship between solar and lithium batteries, but solar power savings can extend battery life by 50 percent. It may not do all your heavy energy lifting—looking at you, fridge and AC—but it's often plenty to charge devices, run small appliances, and keep the lights on.

Shop solar solutions at GoPowerSolar.com



MAKE BETTER AIRFLOW A CONSTANT REDIRECT AIR TO WHERE IT'S INTENDED

Think improving your airflow by 40 percent makes a difference in energy use? It does. Better airflow reduces your AC's energy consumption and, in turn, makes your unit faster and more efficient. (Which could eliminate an assumed need to purchase a second AC.)

Shop at RVAirflow.com.



ACCELERATE YOUR COOL DOWN A MORE EFFICIENT AC UNIT

Getting your temp down faster means your AC unit can focus on maintaining a constant temp. If you doubt your AC can do that, it's probably time to upgrade to the Dometic FreshJet 3—with its 13 percent increased cooling capacity. **\$1,049.99 at Dometic.com**

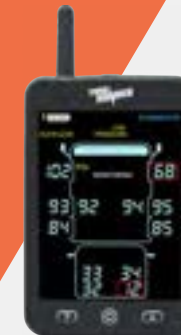

SUSTAIN A TIGHT RADIUS: YOUR TIRES PROPER INFLATION SAVES GAS MILEAGE

If we're gonna talk about saving energy, let's mention saving gas. One sneaky smart (and extra-safe) way to do that is tire pressure. Maintaining recommended pressure can save you up to three percent on gas. So, that TPMS you're buying? It can pay for itself. **Shop at TireMinder.com**



SUBTRACT SOME SURFACE HEAT YOUR WINDOWS ARE BLEEDING ENERGY

RV window surfaces get brutalized by the sun in the Summer and by the cold in the Winter. That takes a severe energy toll on your climate control. MagneShade gives you 90 percent UV protection and helps you keep your energy, be that cool or heat. **Shop MagneShade.com**

IMPROVE THE ROOFING VARIABLE KEEP YOUR COOL SEALED IN THE CABIN

UV protection and air retention are big factors that have a common denominator: your roof. RV roof replacement can significantly reduce temperature in your cabin—RV Roofing Solutions says about 10 percent. FlexArmor's patented formula and professional install also comes with some big guarantees: no-leaks, no maintenance, and no more caulking. **Explore options at RVRoof.com and RVRoofingSolutions.com.**



COOK WITH A SMARTER SURFACE STREAMLINE YOUR ENERGY TRANSFER

Furrion's double burner induction cooktop cooks food faster. It also channels heat directly into the cookware. That all equals less power in less time. **\$445.95 at lci.com**



LIGHTEN THE KITCHEN HEAVYWEIGHT WATCH THOSE POWER CALORIES, BIG GUY

Fridges can steal your RV power like a schoolyard bully robbing a kid's lunch money. But smart fridges like the Polar N10DC compressor refrigerator can be huge energy savers—with digitally adjustable temperatures and a night mode that reduces compressor and fan speed to conserve battery charge. **\$1,559.99 MSRP**



REPLACE A VARIABLE: GO LED INSIDE, OUTSIDE, EVERYWHERE YOU CAN

It sounds simple, but it makes a difference. Switching to low-energy LED bulbs when and where you can (inside and out) conserves energy. And it beats dad turning off all the lights all the time. **Shop LED lights at SalVinCo.com**

Fractions That Add Up

A few small parts that matter a whole lot.

Photos courtesy of respective manufacturers

21 NIGHTS
COMPLIMENTARY*
CAMPING

\$1000 VALUE

Call us today!

855.481.7411

CALL WITHIN 7 DAYS TO RECEIVE YOUR **SURPRISE BONUS GIFT!**



MAKE GEORGIA YOUR NEXT STOP!

Fifty-five acres make up our beautiful North Shore Resort at Lake Oconee, GA. The campground was developed with a "railroad" theme and 23 railroad cars were brought in and used as offices, in recreational areas, as shops, and as overnight accommodations. Club cars, cabooses, and boxcars were used in the design scheme giving the resort a truly unique flavor for your next vacation stay.



THE BEST CAMPING ON THE RIVER!

The perfect vacation destination located directly on the picturesque Mohican River in the heart of Ohio's Amish country. At Wally World you'll have the best camping sites on the river at a clean and family-oriented campground. With access to a full range of amenities and easy access to so many area attractions you'll want to come back again and again!



RELIVE THE GETTYSBURG EXPERIENCE!

Located on the southern edge of the most famous Civil War battlefield, our amazing campground resort provides by far the best setting for the perfect family getaway. Whether you're soaking up American history or sun by our Olympic size swimming pool, you will discover unlimited opportunities for epic fun and relaxation at Gettysburg Battlefield Resort.



FLORIDA FUN!

Whether you enjoy fan boat rides through the Florida wetlands, viewing world class wildlife, horseback riding, boating, fishing for largemouth bass, ziplining, Busch Gardens in nearby Tampa, Orlando attractions such as Disney and Universal Studios, attending a pro sporting event such as The Tampa Bay Buccaneers or just hanging at the resort pool, Thousand Palms will meet all your vacation needs.



RELAX AT BASS LAKE!

Our activities and events are second to none, and take place year-round. Not to mention our two outdoor swimming pools; two clubhouses, one for families as well as one just for the adults; a miniature golf course; a restaurant and bar, a country store; nature trails, for both short walks and long hikes; laundry facilities and much more. As a gated and secure year-round resort, there's always a comfortable, safe and warm sense of community.



NORTH CAROLINA AT ITS BEST!

Come experience one of North Carolina's most beautiful campground resorts, located just minutes from historic Pinehurst. Explore and enjoy everything Sycamore Lodge has to offer, from our historic main lodge and 200 acre forest to our private stocked lake, beach and swimming pool.



LIFE'S AN ADVENTURE, ENJOY THE RIDE!

Located in the Salt Fork Lake Region. With over 850 pristine acres, this resort truly has something for everyone. Nestled in one of Ohio's most spectacular forests. You don't even need to leave the ranch for an adventure-packed vacation as amenities include: indoor heated pool, outdoor pool, horseback riding & trails, golf driving range, mini golf, paintball and so much more!



Boulder County Fairgrounds Campground

9595 Nelson Road
Longmont, CO 80501

(303) 682-6762

Road Trip: Few breweries in the country are as innovative as **Left Hand Brewing Company**. These guys—two former Air Force vets—are mad scientists, always bucking industry trends. And it works. Just taste their Pumpkin Spice Latte Nitro—or any nitro for that matter. And whatever you love, buy some to take back to the campground. *3-minute drive*

Daily Rate: \$25
Camp Sites: 96

WATER	■	STORE	■
SEWAGE	■	LAUNDRY	■
ELECTRIC	■	WI-FI	■
PROPANE	■	PET-CARE	■

Check-In/Out: 10 am/10 am

BoulderCounty.gov

Bear Creek Lake Park

15600 W. Morrison Road
Lakewood, CO 80228

(303) 697-6159

Road Trip: It's not easy finding a great campground near downtown Denver, but the payoff is big. Mainly, decent proximity to the **Great Divide Brewing Company**. You'll thank us kindly once you try their Yeti Imperial Stout. The bold malt flavor smoothly transitions to sublime caramel and toffee notes. Exactly what you'd expect in this craft beer Mecca. *33-minute drive*

Daily Rate: \$35
Camp Sites: 34

WATER	■	STORE	■
SEWAGE	■	LAUNDRY	■
ELECTRIC	■	WI-FI	■
PROPANE	■	PET-CARE	■

Check-In/Out: 1 pm/12 pm

Lakewood.org

Tiger Run Resort

85 Revett Drive
Breckenridge, CO 80424

(970) 453-9690

Road Trip: Fall in Colorado is not like Fall in California—or even Virginia. You're in the Rockies, which means it could snow, especially in Breckenridge. All the better to be within a short drive (or long walk) from the **Broken Compass Brewing Company** and its Snow Blind Double IPA. At 8.2 percent ABV, being holed up somewhere just might get more fun. *7-minute drive*

Daily Rate: \$60-165
Camp Sites: 371

WATER	■	STORE	■
SEWAGE	■	LAUNDRY	■
ELECTRIC	■	WI-FI	■
PROPANE	■	PET-CARE	■

Check-In/Out: 1 pm/11 am

TigerRunResort.com

Red Mountain Motel & RV Park

664 Greene Street
Silverton, CO 81433

(970) 387-5512

Road Trip: Smack dab in the middle of the forested San Juan Mountains, Silverton is just cool. It's a small town (651 people in 2021) and everything is nearby—including the **Golden Block Brewery**. You don't even have to think about getting behind the wheel as you enjoy a pint of Whoop Arse Scottish Ale—a smoky medium-roast malt with brown sugar notes. *8-minute walk*

Daily Rate: \$63-66
Camp Sites: 50

WATER	■	STORE	■
SEWAGE	■	LAUNDRY	■
ELECTRIC	■	WI-FI	■
PROPANE	■	PET-CARE	■

Check-In/Out: 1 pm/10 am

RedMTMotelRVPK.com

This offer is sponsored by Travel Resorts of America and includes up to 21 nights of complimentary camping and a 90-minute VIP tour (some restrictions apply). No purchase necessary. All camping certificates are redeemable at any of our private resorts and valid up to one year. These certificates entitle you up to 7 nights of complimentary camping during peak season, and two certificates of up to 7 nights each of complimentary camping during non-peak season. These certificates have no cash value and are non-transferable. Offer not valid if you have toured one of our resorts within the last 24 months, if you are a current Travel Resorts of America or Coast to Coast member, or you keep your RV on a permanent site. Please call toll-free at 1-888-481-7411 to activate your certificate. Calls will be recorded for training and compliance.

Your Next Getaway Plan

Sidestep the beach when you snowbird this Winter. Here are 4 coastal nests juusst outside the usual hotspots.

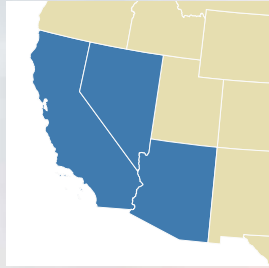

PACIFIC

Fernwood Resort

Big Sur, CA
FernwoodBigSur.com

• Everyone loves snowbirding in San Diego (if you've got the dough). But snowbirding Big Sur is different. And the Fernwood Resort gets that. Here, nature is your neighbor. You can hike right into Pfeiffer Big Sur State Park from your campsite. And park by the Big Sur River under great tree cover. With a store and a restaurant onsite, you can do almost everything on foot.



If you like to surf—or want to learn—Winter is your opportunity to ride giants. The big waves come then. Lucky for you, the beach is a short drive away from the resort.

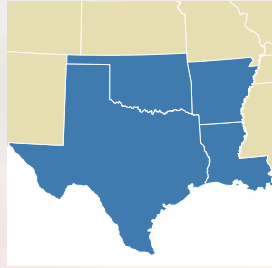

WEST GULF

Trinity Bay RV Lodging

Anahuac, TX
TrinityBayRVLodging.com

• Texas, like Florida, is a snowbird magnet. And rubbing up against the warm waters of the Gulf of Mexico isn't hurting anything. Trinity Bay RV Lodging takes you out of Houston's bustle and parks you a few hundred feet from the bay. With 75 concrete sites, lush scenery, great amenities, and reasonable rates, it's perfect—whether you're remote working or just lounging.



When you're ready to launch out, jump over to Space Center Houston. It's great for any age, but if you've got kids or grandkids, bring 'em. They'll have a blast.

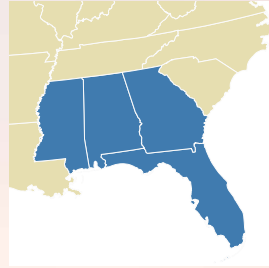

SOUTH COAST

Champions Run

Ocala, FL
Sunlight-Resorts.com

• Sometimes, you just want everything right where you park. Champion's Run certainly thinks so. The beach is still under an hour away, but you might be too busy to go. This Sunlight Resorts community has 387 sites, concrete pads, free high-speed Wi-Fi, a 12,000-foot clubhouse, pickleball courts, resort-style pools, billiards, ballrooms ... sorry ... lost my breath there. Just so much stuff.



We were kidding before. We know you need to get out. And 10 minutes away, you can find any adventure you like—ziplines, kayaking, riding horses, and more—at Zip the Canyons.

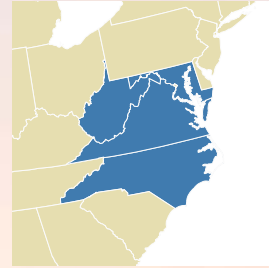

ATLANTIC

Holden Beach RV Campground

Supply, NC
HBRV.net

• Halfway between Myrtle Beach to the south and Wilmington to the north (and about an hour from each), is the Holden Beach RV Campground. Out of the way, these private grounds are an absolute gem. Covered by mature live oaks, the sites are clean. The amenities are wonderfully complete. And the Atlantic is merely two miles away—with a Tiki Trolley Beach Shuttle to take you there.



Take a guided kayak tour and paddle along the narrow Intercoastal Way. Keep your eyes peeled for spotted dolphins and loggerhead turtles during the two-hour saltwater cruise.

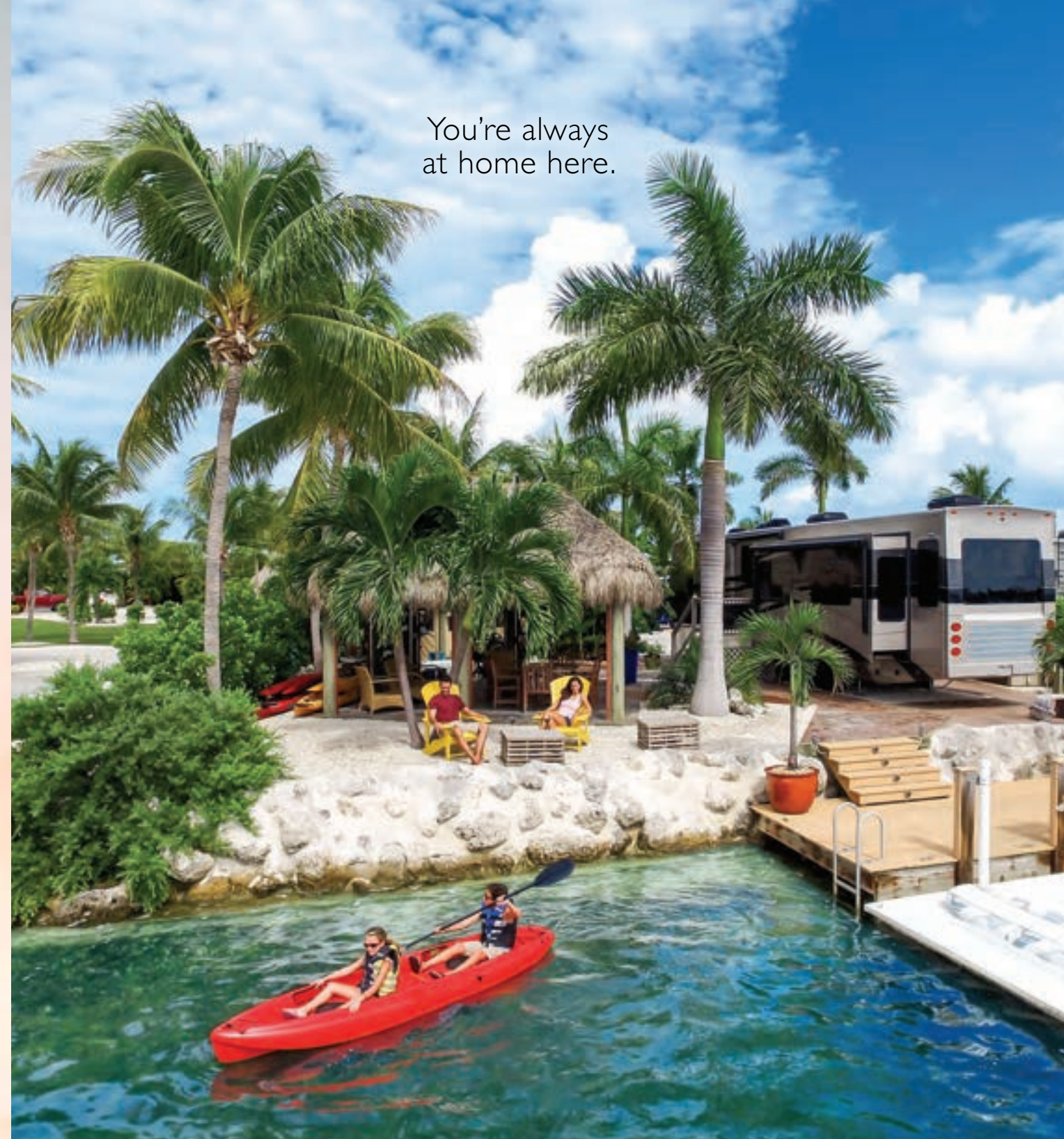

You're always at home here.

They say that home is where the heart is. Maybe that's why so many people have fallen in love with Big Pine Key and Florida's Lower Keys. As home to two wildlife refuges, epic ocean views, miles of unspoiled wilderness and everything from cozy campsites to luxurious RV parks, and Stock Island's delightful restaurants and rustic charm, Florida's Lower Keys should be at the top of your vacation list.

fla-keys.com/lowerkeys 1.800.872.3722



Autumn's Golden Place in the Sun

By Mark Settle

The LURE OF GOLD

has a rich history in California. Since 1849, when the first prospector pans glimmered yellow in the sun, the West has glowed with the promise of sudden fortune. Indeed, John Steinbeck, the great American author of *East of Eden* and *Of Mice and Men* fame, tells stories of how the valleys swiftly began to swell with people.

Now, although the sprint to San Francisco may have slowed long ago, in Temecula, California, the journeys have not ceased. Even today, fortunes can be made in a day and dreams fulfilled in a moment. There is gold here, but you don't dig for it. Or sift for it. Here, you play.

Small wonder that RVers from Chicago to Canada rush to the Pechanga Casino RV Resort in Temecula. You see, campers

know a thing or two about getting the odds in their favor—about being in the right place at the right time. Today's RVer is an increasingly savvy customer. Always a connoisseur of place, they know exactly how to extract the most out of a golden opportunity. And in the best places, opportunity goes well beyond the campsite—even one as enchanting as Pechanga.

Going all-in at the Pechanga Casino RV Resort is a big play. But it takes an RV to make the most of Temecula.



PECHANGA
RESORT CASINO™

California's King of Casinos

Among casinos, Pechanga is a name that needs little introduction. In the United States, it's among the largest casinos west of the Mississippi. (If your geography is a little rusty, you might note that that includes all of Las Vegas.) The grandeur of its gaming experience rivals the best in the world—be that Macau, Singapore, or Sin City. The scale of Pechanga's splendor is mind-boggling. A pool complex the length of five football fields, complete with a swim-up bar. Two deluxe but intimate entertainment venues offer two events a week for guests, hosting live music and world-class comedians. (Jerry Seinfeld appeared just last August.) There is a

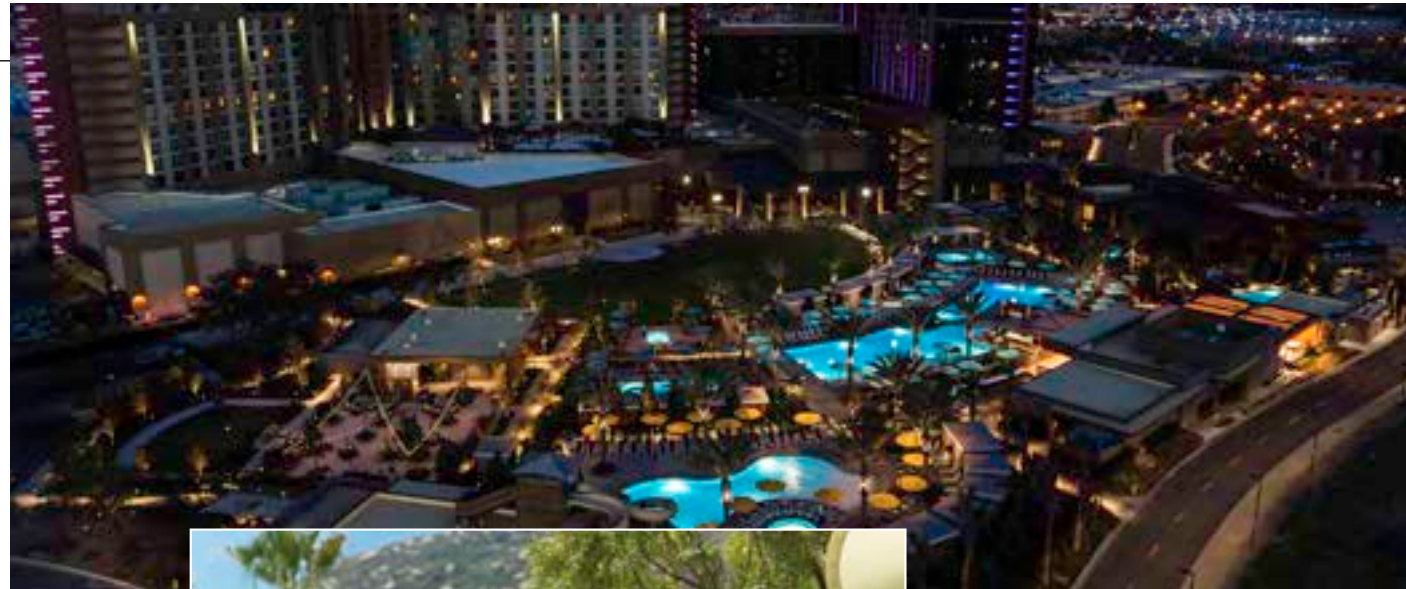

luxury two-story spa with treatments using native botanicals, 20 bars and restaurants, 18 holes of championship golf, and—of course—games. Lots of them. Visitors can enjoy a completely smoke-free 200,000-square-foot playground with over 5,500 state-of-the-art slot machines and 152 table games.



SNEAK A PEEK INTO THE PECHANGA CASINO RV RESORT

But the best part is that the resort not only loves to host its RV guests, it also carefully caters to their specific needs. Just a few hundred feet away.

Taking Exit 58 off Interstate 15 onto Temecula Parkway, you're just an eight-minute drive south to the RV resort. In less than a mile, you'll merge right onto Pechanga Parkway and proceed through an open roadway lined with trees. Under a wide-open sky, some are in color; others are a vibrant green; a few, with their signature palm fronds, announce your westward advance. Just ten miles from the ocean as the crow flies, with the windows down you can feel the mild, comfortable touch of a Pacific breeze. The Pechanga Casino Resort appears on the right, and down the road, an overhead sign

Photos courtesy of Pechanga Casino RV Resort

indicates the entrance to the RV resort. Turning right onto Oak Road Drive, you will see the registration desk.

Michael Feeley, the Executive Director of Pechanga Development Corporation at the resort, notes, "Our location is so perfect. When you drive in, you're away from the street so that you don't feel like you're a part of a parking lot. When you pull in, you see beautiful landscaping with a mountain backdrop. In between the RV resort park and the mountain is a Pechanga's championship Journey golf course."

Although you can sign-in electronically (a service that Michael says is increasingly utilized by guests), you can also walk in and be greeted by guest service agents at the desk who will happily go over resort specifics, including your campsite.

Exiting your RV, you'll feel the California Autumn air. Michael notes, "It's very mild, very comfortable." That too is a good way to describe the campsites. Spacious sites are all around. All with picnic tables and lawns. Premium sites have added pergolas and barbecues. You get an immediate sense that your needs are anticipated here. And that includes things you can even sense if not see. Michael laughs, "Wi-Fi is one of those things that you can't hear it; you can't see it; you can't smell it; you can't taste it; but you know when it's not there." He proudly points out the upgrade the resort underwent last year, "That was a big priority for us. We'd put

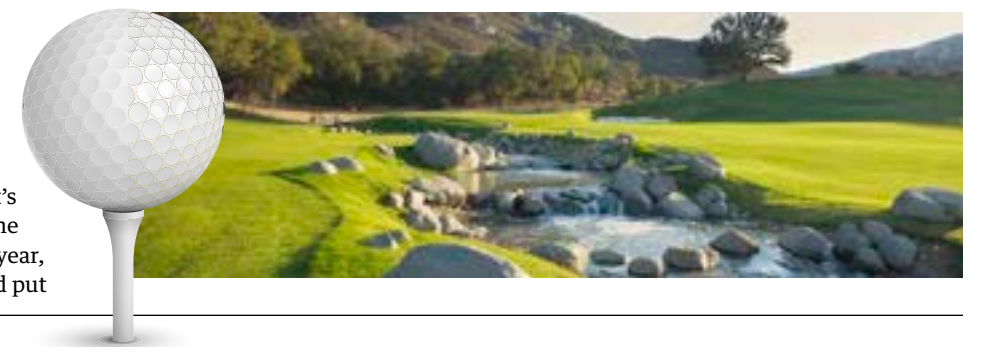

WHEN IT NEEDS TO LAST A LIFETIME. SPRAY IT ON.

FlexArmor is the only professionally sprayed-on RV Roof with a lifetime no-leak guarantee.



Can't Do *THIS* With A Roll-On Product

Request A FREE Sample
Visit RVRoof.com

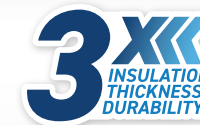

FREE ESTIMATES & ROOF INSPECTIONS

(844) 353-9276



don't want to pay the rates to be in Palm Springs, LA, or San Diego. Not to mention, our reputation continues to grow and grow."

Clearly, Michael is onto something. For, as alluring as the glow of Pechanga is, being perfectly and affordably parked to stage a series of great road trips ... well, that's exactly what RVers look for.

this RV resort up against any RV resort for Wi-Fi reception."

Michael says that (outside the magnetic pull of the Pechanga Casino) there are two big reasons RVers choose to stay at the resort: amenities and access. The amenities truly are robust, and attract guests looking for both short and seasonal stays. While most stay for six days (or nights), more and more are staying 28 days. And they come from all walks of life. Traveling nurses, subcontractors, and RVers working from home all find what they're looking for at Pechanga: great Wi-Fi, full hookups, three sets of showers and restrooms, dog parks, clubhouses, convenience stores, pools, propane, onsite dump stations, on and on and on. There's even a nail salon and affordable pizza place nearby. All of which RVers are hunting for.

But what makes Temecula a truly sweet spot is its geographic access, which, Michael says, RVers are quick to notice.

"I also believe that they are savvy as well. They might want to do the Southwest, whether it includes the Grand Canyon, Las Vegas, and Southern California. We are perched right between Los Angeles and San Diego. We have great access to both cities, to the ocean, and to wine country. We're about an hour and 20 minutes from Palm Springs."

Coupled with the proximity, Michael notes, is the price. "Our access just lends itself to RVers. They don't want to pay the rates to be on the coast, and they

"OUR ACCESS JUST LENDS ITSELF TO RVERS. THEY DON'T WANT TO PAY THE RATES TO BE ON THE COAST, AND THEY DON'T WANT TO PAY THE RATES TO BE IN PALM SPRINGS, LA, OR SAN DIEGO. NOT TO MENTION, OUR REPUTATION CONTINUES TO GROW AND GROW."



Access to Every RV Desire

For all the attraction of the casino, and its enticing luxury, Temecula is different from Las Vegas. Very different. Temecula is not a desert; it's a valley—a long linear-shaped lowland that lies in the gentle shadows of the Sierra Temescal. The air is filled with ocean breeze. In contrast with the frenetic fervor that pulses through Vegas, Temecula seems to recline. While Vegas flashes neon lights, Temecula is a land illuminated by sunsets; while Vegas vaunts gaudy caricatures of the world, Temecula's Mission Revival style is more local and softer on the eye, with its rounded arches and adobe tones; and while Vegas swarms with tourists shoulder to shoulder, Temecula gives you space to breathe. Its name, given by the Payomkawichim (Western People) is derived from Teméku (Teh-MEH-koo), meaning "where there is sun."

Temecula is confident in who it is, which is impressive enough. Especially in the Fall and especially for campers savvy enough to park there in season.

Michael, a local himself, confesses, "Fall is probably my favorite time of year." The climate is especially mild. A range of trees burst into color while others resolutely remain green. The gold autumn sun shines down on the valley. It is a satisfying time to be outdoors, and your RV gives you the range to explore every gilded corner.

Situated almost squarely between Los Angeles and San Diego, Temecula's a town with a little bit for everyone. It is ringed with things to do and places to explore. Championship golf covers these hills, from the Temecula Creek Golf Club's 27 holes only five minutes away or Journey onsite at your homebase at Pechanga. Over 50 wineries wind

5 DETOURS IN DRIVING DISTANCE

1 **61 Miles**
SAN DIEGO
Take I-15 S and explore Balboa Park in "America's Finest City."

2 **76 Miles**
PALM SPRINGS
Strike east to survey the Sonoran Desert from the Aerial Tramway.

3 **89 Miles**
LOS ANGELES
Head up I-15 N to hike Hollyridge Trail—and take a selfie—at Hollywood.

4 **110 Miles**
JOSHUA TREE
Trek to a weird—and awesome—oasis at Fortynine Palms.

5 **460 Miles**
GRAND CANYON
Seize this bucket-list opportunity. It's long but absolutely unforgettable.

through and around the hill immediately due east of the town like one long, luxuriant vine. Many even have live music. Lifting your eyes to the expansive sky, expect to see hot air balloons by the dozen in the early hours, moving as blissfully and leisurely as everything else in Temecula.

In Temecula's Old Town, you'll find privately owned restaurants. Gastro pubs and bars. Streets lined with trees and foliage. "It's a beautiful little city," says Michael in a voice that sounds like a smile. When asked where he recommends eating, he waits for a moment with the weight of deciding which restaurant deserves first mention. Finally, he says, "Great Oak Steakhouse." But when asked what he orders there, he doesn't hesitate a second: "Ribeye!"

Michael laughs and then rattles off a list of the other incredible dining experiences that made his first response so hard: Old Town Goat and Vine (modern Italian) and Devilicious Eatery & Taproom (a speakeasy with the best pub food in town). There's also Cork Fire Kitchen, a restaurant at the premier Temecula Creek Inn that has won multiple awards. Michael notes that it's a chef-driven menu, so, "I usually lean toward the fish."

Temecula's myriad dining options are mirrored in the winery and pub scene. Enchanting locations like Leoness Cellars present a paradise of options for day dates and date nights. Stroll hand-in-hand through the vineyards. Gaze eye-to-eye over a wine tasting. You could even take a bottle of their 2018 Vineyard Series Cabernet Sauvignon and head to a "sip-and-paint" class. But, perhaps best of all, would be to head out into the autumn sun and open it there. Whether that is floating in a hot air balloon, after riding horses over the hills, or stopping at the perfect scenic spot on your hike up the Vail Lake Loop—that's up to you and the person you love.





The Power to Clean!

Environmentally responsible cleaners for the interior and exterior of your RV, motorhome, or home.

GabesPride.com

Made in U.S.A.



“There’s so much you can do here,” Michael says, “It offers everything you could possibly want.” Circle through the perfect excursion combos that envelope the town. Or you can stretch your RV’s road legs out to Los Angeles and San Diego, Palm Springs and the Grand Canyon. But when all else fails—and possibly your energy after so many worthy excursions—you can always return to the resort, where there’s a place to play just a short walk from home.

Where You Feel Lucky

No matter your prospects at the casino on any given night, as a guest at the Pechanga Casino RV Resort, you are always striking gold. Some nights that might be after a golden afternoon eating and drinking among the sunlit hills of Temecula. Other nights it might be making a starlit stroll back to your RV still tingling with the thrill of winning a game of chance. It’s only a few hundred feet, but even in that short span, you’ll smile at the temptations that surround you here. The Cove’s illuminated pools warble with blue water and golden light. You pass the spa. You pass the golf course clubhouse, and the fulsome silence that lies over every green. The night air is cool with the faintest hint of salt. And approaching your spacious campsite, you may feel a reluctance to withdraw into the cabin of your RV just yet. But when you do, you’ll lie down, close your eyes, and feel lucky.

While Las Vegas may be a place to go, Pechanga feels more like a place to be. Here, there is gold without the rush. A thousand opportunities to make a golden moment. To pause for a season and harvest the pleasures of the earth. To enjoy your place in the sun. ❤️

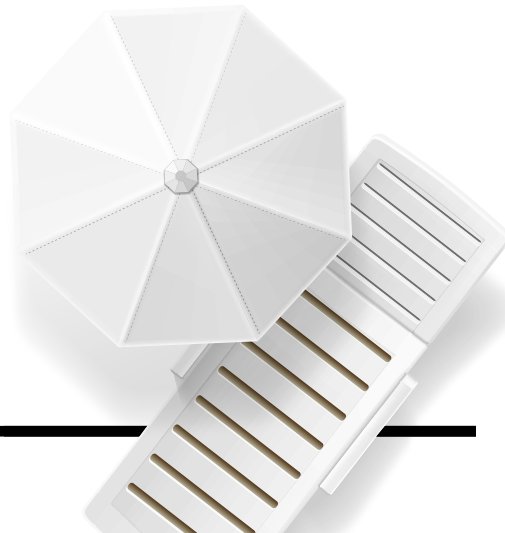

RVX



INSIDE:
Take that adventure van test drive to a whole new level! Page 65

CAMPING, ADVENTURE, AND THE RV EXPERIENCE

Li³ghting Your Next Adventure

Take your campsite to the next level, with the plug-and-play Outlaw® 1072S Portable Power Station.

Built exclusively for off-grid adventure, Outlaw packs 921-watt hours of clean lithium power.

That’s enough to keep you going through the night. And then some.



LEVEL UP YOUR CAMPSITE



RELi³ON®

BY LAND AND BY SEA

You might call the Blake family fearless. But you’d be wrong. Rollicking over Utah’s red rocks and staring down at the abyss below. Close encounters sailing a four-day journey across the Gulf of Mexico—all with two toddlers in tow. There is indeed fear. Even so, this family of four is always at home so long as they are together. On the next page, get a glimpse into the spine-tingling adventures that define their nomadic life.

Photos courtesy of @theboatnotes

*Braving Utah
switchbacks by
land and crossing
the Gulf by sea
will bring you face
to face with the
unexpected. There
are breakdowns.
Meltdowns. And
close calls. But for
our family, each
memory is a picture
of home.*

THE HEART OF A

by Olivia de Soria

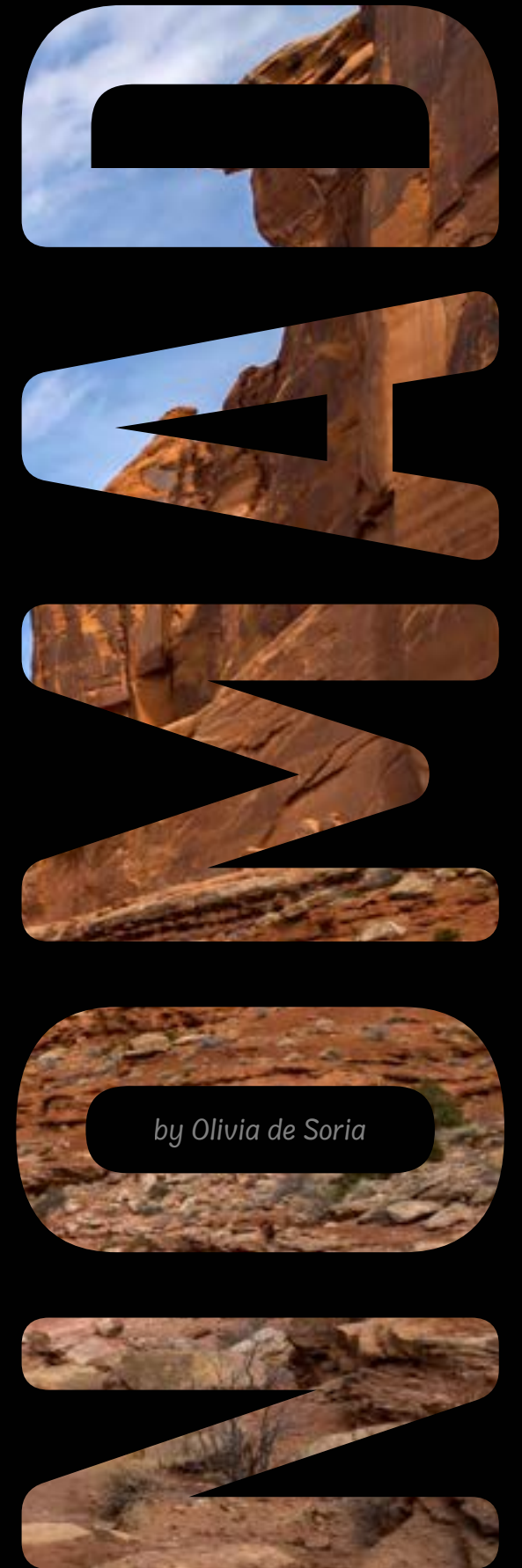

IMAGINE RAISING YOUR CHILDREN WITH NO HOME. No brick. No mortar. No foundation. Just family. It sounds chaotic, right? And dangerous. Something no parent in their right mind would intentionally choose. But our family chose to make that very decision, replacing the four stable walls of home with only the comfort of each other.

Under the awning of our RV, we watch the stars make their slow appearance above the Mojave Desert. We are isolated, uprooted, and free in our solitude. There isn't a fellow human in sight, and it feels like we are the sole inhabitants of another planet. As the sun kisses the desert's rugged horizon, the outstretched arms of countless Joshua trees lift their hands from darkness into light.

This is a new place, a different vantage point, a different sunset. And we are home because we are together.

“We live a transient life by boat and RV.”

We are the Blakes, and our nomadic life is constantly redefining what home means for our family of four. A few weeks after my husband, Adam, and I started dating, we hit the road on his 750cc Honda Nighthawk. From Asheville, North Carolina to the California coast, we sat on the back of his motorcycle, on a cheap hotel pillow,

“
AFTER ADJUSTING
OUR HABITS AND
MINDSETS, WE
HAVE MANAGED
TO TRANSFORM
THE CUSTOMARY
CURRENCIES
OF LIFE FROM
MONEY AND
POSSESSIONS TO
FREEDOM AND
MEMORIES.
”

for two and a half weeks. His work was seasonal, and I had just been fired from yet another waitressing job. I remember riding outside Las Vegas in August. It was stiflingly hot. The air was so dry, the scenery could cut you like a knife. For hours, we sat in silence and let the world spin around us. We connected through this rugged landscape. With virtually no money, it was the freest I have ever felt. But it was also the most vulnerable. I have grown to love that feeling of instability, insecurity, and uncertainty. That is where inner growth happens—the deep kind that changes your life. I think Adam and I both knew on a subconscious level that we had that in common. Before we met, Adam spent a year living in a teepee in the mountains of Western North Carolina. He made his own teepee poles and moved into the woods to live outside.—just because. He encountered bears and endured subfreezing temperatures all in an effort to be close to the land. Adam is proof that you don't have to go to Bali to see the wild.

The nomadic spirit lives deep inside us, and for Adam and I, it defines us. We rode every day on his motorcycle and camped every night until we reached California's coast. On the back of that bike I felt safe; I felt loved; and I felt like myself. I think that was my first taste of home. And now, with our 5-year-old Emilia and 2-year-old Pepper, home is wherever they are. And for them, it's wherever we are. We live a transient life, by boat and RV. After adjusting our habits and mindsets, we have managed to transform the customary currencies of life from money and possessions to freedom and memories.

“Cell service was long since gone.”

Just last year, we went back and retraced our cross country motorcycle road trip—this time with an RV and two kids. From North Carolina to California, we let the breathtaking scenery of the American landscape embrace us. (With a little more chatter from the backseats.) Two epic breakdowns and over 2,000 miles later, we made it to our most anticipated destination: Moab. After years of revisiting Utah's landscapes in our minds, we were eager to feel that dry air again. We parked our travel trailer

about halfway up the canyon as the road narrowed in the foreground of endlessly tight switchbacks. The drop-off was heart-stopping, falling into the abyss of red rock and space. The view darted into my chest. I felt like a twist of lemon balancing precariously on the edge of a martini glass. The road behind me etched a winding contour through the canyon like an endless tapeworm. Turning around was no longer a possibility. As the tendrils of anxiety crept to the surface of



at Goose Island Campground and wasted no time in satiating our wanderlust. Skipping the crowds at the national parks, we took a side road to go exploring. We headed towards a road sign called “Scenic Byway U-279.” Minutes passed as the landscape broke apart and redistributed itself into color, sun, rock and sky. We were headed into the flat dry washbowl of Dead Horse Canyon.

The pavement slowly disintegrated to gravel and dust. We stopped to study a national park information sign with a map of Potash Road, or Shafer Trail as it was known. Cell service was long since gone. The visitor's center was only 10 miles away on the map, so we continued on. The road bumped along, past the Potash Ponds at the base of Dead Horse Canyon. The bottom of the canyon felt heavy, prehistoric and sacred. About an hour in, we had to get out and line a path of large flat rocks for the wheels of our car to pass over a ditch. We were officially off roading. A picture of what we had gotten ourselves into began to form in our minds. We were climbing up the sheer, straight walls of Dead Horse Canyon.

A drop off appeared on our left, hundreds of feet deep. Adam looked at me, “I don't think we should be here.” But what would be more hazardous: continuing on, or trying to turn our car around without enough space to do it safely and retracing our tracks all over again? We continued on, still confident that the visitor's center was around the corner. It wasn't. Adam's grip on the wheel tightened. The drop offs went from hundreds of feet to thousands. The sun's heat made the scene before us absolute and unforgiving. (Luckily, the bumps in the road put our kids to sleep from the beginning of our drive. I don't think I could have faced the road ahead of us with the unrelenting inquisition of two toddlers behind us.) We were

my consciousness, like clockwork, both the children woke up. Their inquisition began just in time to turn a corner into the parking lot of the Canyonlands Visitor Center. A park ranger congratulated us on our completion of the legendary Potash off roading trail, also known as Wallstreet.

I felt like I had just stepped into a pair of binoculars and emerged integrated with the landscape. So much time traveling is spent chasing the scenery; it's rare to find a moment where you can actually step into the view. These spine-tingling adventures are a defining feature of our lives. Whether it's our luck, or an inescapable attribute of a nomadic lifestyle, I will never know. I can only live my life, and occasionally wonder how it compares to others. RV life is one of many ways to indulge the travel fever. You can hotel hop, resort hop, or Airbnb your way around the world. But what we love about being sailboat and RV owners is that you earn the right to call yourself a local wherever you go. Traveling with



Light Your RV with Earth-Friendly LEDs

12v Bee Green LED lights and bulbs include:

- Extremely Low Profile Ceiling Lights
- Reading Lights with USB Charge Ports
- New Tech with Amazingly Even Light Patterns
- New 3-in-1 Color Temp Pancake Light with Dimmer
- Dual Color Fixtures and Replacement LED Bulb
- Variety of Fixture and LED Color Options

Save Power. Bee Green.

Learn more at www.beegreenled.com
941-378-9727



Sold by SalVinCo LLC

RVX > THE HEART OF A NOMAD

“
THESE SPINE-TINGLING
ADVENTURES ARE A
DEFINING FEATURE OF
OUR LIVES. WHETHER
IT'S OUR LUCK, OR
AN INESCAPABLE
ATTRIBUTE OF A
NOMADIC LIFESTYLE,
I WILL NEVER KNOW. I
CAN ONLY LIVE MY LIFE,
AND OCCASIONALLY
WONDER HOW IT
COMPARES TO OTHERS.
”

your house in tow is a labor that bears a special kind of fruit. Anyone can see Mexico from the balcony of a Sandals resort. But to watch it come into view from the bow of a sailboat after four days of open ocean, that's special.

“After four days of open ocean”

A few months prior to our cross-country RV trip, we made a crossing of another kind: the Gulf of Mexico. For 10 years, Adam and I have been intermittently sailing on the protected waters of the Intercoastal Waterway. We started with a busted 28-foot sailboat, and graduated to a reliable 38-foot Catamaran. Crossing the Gulf of Mexico was going to be a crash course in blue-water sailing. It was like taking a casual poker game from your kitchen table to high stakes poker in Las Vegas.

Feeling enormously unprepared, we set sail from the Dry Tortugas with white knuckles on the rails. Land disappeared from sight, and the ocean swells steadily built around our boat. Just then, I spotted a partially deflated dinghy pitching aimlessly amid the swells. We came alongside it to make sure there was no one inside. It was an empty and pitiful sight, filled with all our worst imaginings. I tried not to think of this as the start of one of those terrible sailing movies where the title gives away the ending. (You know, like

“Adrift.”) Then, even more foreboding, Adam spotted a lone flip-flop trailing along behind the half sunken dinghy. I couldn't make this up if I tried. We all quietly tried to shake off our most morbid thoughts and continue forward. In my own mind, I gave each of my friends back home a watery-eyed hug, as our isolated boat bobbed atop the rolling hills of an endless seascape.

In the evening, spotted dolphins appeared at the bow, bursting with playful energy. They reminded me of

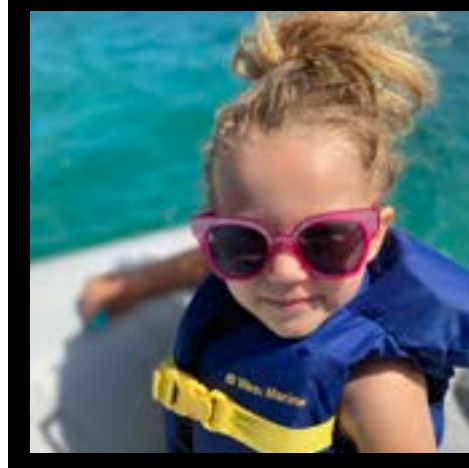
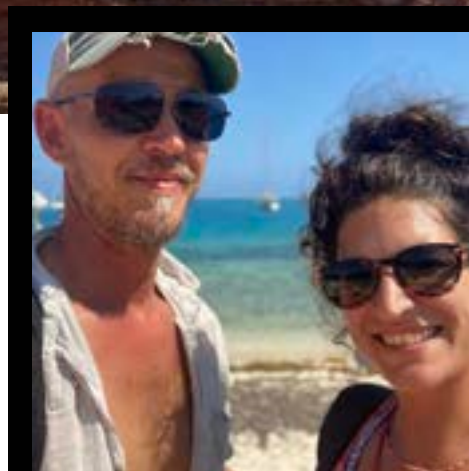
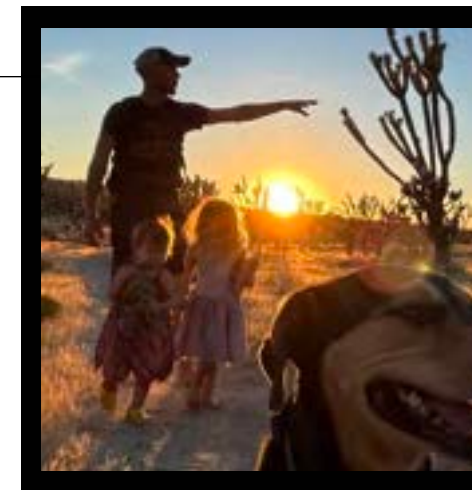

my children, overflowing with laughter and light. They kept arriving in groups of twos and threes from their villages in the sea, until we had a convoy of mammals preceding us. They eased the tension and isolation we all felt. Late that night I lay awake in our bed as the water slapped the hulls of the boat. The kids were sound asleep on either side of me, unphased by our endless bobbing about. They were too young to be bothered by the existential agonies that clinched my every nerve. But even I was unaware of the real crisis taking place above deck while I lay sleepless below.

The next morning, Adam relayed our near collision with a container ship the previous night. He described how a massive ship had materialized on the horizon line—darker than the night and big as a skyscraper. The AIS alarm (automatic tracking system) didn't go off when it should have. Adam saw the ship, but the port and stern lights

weren't visible, making the scene even more confusing. The red and green lights weren't visible because the ship was pointed directly at us. It was so close Adam could smell the diesel burning off its engines as it turned to avoid hitting us. Being under sail means being at the mercy of the wind, the weather, the current, and the massive, ever-increasing tide of container ships in our oceans.

Follow the Blakes by land—and sea—@theboatnotes on Instagram.

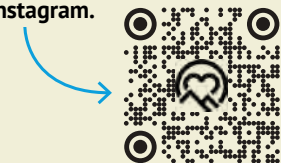

Our second evening was met with an ocean of darkness and an unparalleled display of stars. The water rushed against the side of the boat as we moved steadily on. I sat on night watch and observed our track on the GPS unit move slowly off course as the winds died. Without sufficient wind power, we were at the mercy of the Gulf Stream which carves its way across the Gulf of Mexico not once, but twice. We put more sail out and tried to harness every little spec of wind. The breeze picked up later that night, calming my nerves and putting us back on course. We sailed into the clear blue waters of our destination on the fourth day. Isla Mujeres, Mexico welcomed us into the anchorage with all the quintessential Latin American flavor and flare. I was full to bursting with pride and gratitude for my kids. Their boundless positivity and adaptability was a guiding light on our journey. I wasted no time going ashore to buy my little globetrotters a set of matching hand-embroidered Mexican dresses. Watching Pepper and Emilia's faces as they let the sights, sounds and colors of Mexico register around them was a treasured moment.

like these that the family goes unhinged. But we endure, the moment passes, and we continue on. We redirected our attention away from the cactus chaos and hit the visitor's center to pick up a Junior Ranger Workbook (available at all National Parks). Soon, the sun abated and we took off on a Junior Ranger scavenger hunt. We saw a tarantula, coyote, scorpion, and a rattlesnake all under the luminous light of a Hunter's Moon.

Homeschooling is inevitable for full-time family travel. The National Parks Junior Ranger Program acted as a soft itinerary that doubled as a homeschooling curriculum during our RV travels. Through a worldschooling education model, our children's learning is paired with endless possibilities for applied learning. As a traveling family, we can take our children's education outside the pages of a book, and into the real world. Every school day is a field trip and a learning experience for all of us. No part of this lifestyle comes without a struggle, but watching the faces of my children as they discover new things about the world we live in makes it all feel pretty natural and worthwhile.

After years of traveling, I have learned

“What if your travel is indefinite?”

I love catching little glimpses of the world through their eyes as they make new discoveries. But don't let social media fool you. Traveling with kids is hard. The struggle is real, and embracing it is the only way to success. On our cross-country RV trip, we got to know that struggle really well. Keeping two children safe and entertained from North Carolina to California, and back, was an undertaking that sapped all of my strength. I remember arriving at Saguaro National Park in Arizona after eight grueling hours of driving. The kids were dying to get out of the car. I couldn't find their shoes, and there were no less than six species of cacti in our small RV site alone. The dog escaped and I watched helplessly as she went frolicking amongst the pin cushions. It's moments



“
NO PART OF
THIS LIFESTYLE
COMES WITHOUT
A STRUGGLE, BUT
WATCHING THE
FACES OF MY
CHILDREN AS THEY
DISCOVER NEW
THINGS ABOUT THE
WORLD WE LIVE IN
MAKES IT ALL FEEL
PRETTY NATURAL
AND WORTHWHILE.”



that our memories are like photo albums. No one puts the meltdowns or the temper tantrums in the album that sits on Grandma's coffee table. The present moment of family travel is a mess of uprooted children and parents whirling around each other in a tornado of logistical chaos. After the trip is over and you arrive home, then you can reshape your memories into the idealized story that we all want to hear about. A trip isn't romanticized until the trip is over and you're retelling it from the cozy cushions of your living room couch. Until then, you have to live in the reality of the struggle. But what if your travel is indefinite, and you aren't going home? For us, accepting the struggle is the biggest, and hardest part. It's difficult to give ourselves permission to be imperfect, or to feel uncomfortable, or, horror of horrors: both at the same time. But quite frankly, the challenge is real whether you're sitting under the awning of your RV in a secluded California desert, or sitting on the couch with the remote in your hand.

For now, we have chosen the challenge with an ever-changing view. ❤️

Photos courtesy of @theboatnotes

Photo: Shutterstock/ Cheryl Thomas/Cameramanz/Atoson



The Western Monarch's Majestic Migration

AS BURSTS OF BLACK AND ORANGE break loose from the branches above Pismo Beach grove, you just might gasp. Flitting their wings by the hundreds and thousands on a warm Autumn day, a host of Western Monarch butterflies fill the air. Nor are these tiny migrants native Californians. Like you, they are long-distance travelers. And like you, instinct draws them to warmer climes in the colder months. Sure, you've seen a Monarch butterfly before with its unmistakable Fall colors. But never like this. In this place, the atmosphere is alive with the soft murmur of innumerable silent wings.



I Heart Tip

Bring your kids! And ask the state park staff if they have any caterpillars—and chrysalises—that they can show you.

Peek Into the Grove

Just one look and you'll plan a migration of your own.



WHY GO

There's something unmistakably autumnal about it. The black and the orange. Butterflies falling like leaves. Seeing the Monarch migration is one of those moments where nature feels so personal. Just get your timing right. The season peak hits around Thanksgiving. Also, if you want to see them cluster on eucalyptus branches, go in the morning. But if you want to see

them in flight, go on a sunny afternoon when the temp is at least 55 degrees Fahrenheit

WHERE TO GO

Just off the scenic seaside California State Route 1 (aka "Highway 1"), the Pismo Coast Village RV Resort is a brief two-minute drive from the Monarch Butterfly Grove and within walking distance of the beach.

WHEN TO GO

October to February

LESS-LETHAL SELF-DEFENSE



STARTING AT
\$299.99

- NOT CLASSIFIED AS A FIREARM
- NO BACKGROUND CHECKS
- NO PERMITS REQUIRED
- OVER 7,000 4.5 STAR REVIEWS

 **BYRNA.COM/RV**



THE ULTIMATE TEST DRIVE

WARNER VANS IS DEDICATED TO YOUR ADVENTURE VAN EXPERIENCE—FROM SETUP TO SECRET TRAILS.

By Nate Kennedy

Mercedes Sprinter van conversions are hot right now. Real hot. Like hotter-than-Utah's red-rocks-under-a-noon-sun hot. They're great for driving, on road and off. And they're exquisite for camping. All you have to do is get in one and drive off in the canyons, right? Wrong. And the truth is that no one knows that fact better than Warner Vans in Salt Lake City. Which is why they're doing something unique for customers after the sale. They call it The Warner Way.

I spent some time with Tony Warner, and Tony says The Warner Way is about making sure their clients find a van that's the right fit—then giving them the know-how

to max it out for a lifetime of outdoor adventure.

Here's how The Warner Way works.

DAY 1

Get set up with an expert.

Warner Vans keeps several vehicles onsite specifically for clients

to check out and test drive. There's also a van rental facility on campus, so potential buyers can give multiday, in-the-wild experiences a try. Three nights of rental payments can then be credited towards ownership.

You get a vehicle run-through with a rental, but with a purchase, you get a series of two in-depth orientations—complete with a go-to expert tech and maintenance contact. On Day One, they help connect your smartphones to the system, show you how—and why—to engage 4WD controls, run power outlets, flip fuses, check battery status, and even check/change the fresh and black water. How to turn on air conditioning? Check! And

those secret, secure storage boxes? How to raise the bed? Check, and check!!

With The Warner Way you get a good idea how to operate the vehicle top-to-bottom, and be able to play your favorite podcasts or playlists (like ours on Page 9). Night one, they suggest camping in your driveway. That's right—at home. That way, you can try everything you just learned, and figure out, real-time, the questions you still have.

DAY 2

Take a test drive. A real one.

This is next-level and unique in the entire RV industry. When you're

out on an adventure—your first day trip or just a few overnight trips down the road—a bunch of in-the-moment questions and issues always come up. But with Warner Vans, you're not alone.

The Warner Way program sends a rep along with you. Seriously, a real human in their own van, on standby, to answer any question, at any hour. The rep can stay on the

other side of the campfire or a few miles away. Your choice. But they'll be on call if something in your van has you stumped. Maybe it's turning the front seats around for the entertainment zone, extending the awning, turning on the exterior lights. Doesn't matter.

Double bonus: Warner also has extensive knowledge of the best trails to travel. Their experts have explored the Southwest with the best guides, and have all sorts of routes planned so you can go from wherever you are to wherever you're going safely. That's off-pavement or on the interstate, through incredible backcountry. That's exactly how these vans are built to travel—with you feeling safe, confident, and a little more awesome.



Start the search for your perfect adventure van.



Pro RV gear reviewed by an RV pro.

Subscribe to the I Heart RVing YouTube channel for insights, stories, and knowledge that make camping immersive, convenient, and FUN!

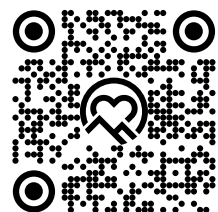

Scan to Subscribe to the I Heart RVing YouTube channel or visit [YouTube.com/@IHeartRVing](https://www.youtube.com/@IHeartRVing)



RV TECH AND TRADECRAFT

TOP LEVEL

13 NEW MODELS READY TO BREAK OUT



WHEN THE FOG LIFTS, the road ahead opens. The only question is: How do you want to drive into the future? Lucky you, you have options—2024 has something for every kind of camper. The new year is here with ultradeluxe diesel pushers and ultralight tiny trailers, unforgettable fifth wheels and 4x4 Class Cs. So, our question remains, “How do you want to drive into the future?” Turn the page and find out.

Photos courtesy of Brinkley RV



LUXURY MOTOR COACHES AND CLASS B MODELS

Information provided for entertainment purposes only and not guaranteed accurate. For up-to-date specifications on all RV models, please contact each respective manufacturer directly prior to making any purchase decisions.

TOP LEVEL > 2024 FIRST LOOK



HOLIDAY RAMBLER ARMADA 40M

Why We Heart This:

Straight up, the Armada 40M might be the fullest expression of “bringing the house” on your next camping blitz. (Really though, it might be more like “bringing the luxury hotel.”) Inside, its expansive living space is floored with heated porcelain tile. There are two exquisite bathrooms. (Yes, we said two bathrooms.) So prepare to bring your whole crew aboard and sail the open road in comfort.

See more at [HolidayRambler.com](https://www.holidayrambler.com).

Specs:

▶ CHASSIS: FREIGHTLINER CUSTOM XCM	▶ EXT LENGTH: 40 FT 1 IN
▶ ENGINE: CUMMINS L9C 380HP	▶ EXT HEIGHT: 12 FT 10 IN
▶ GVWR: 36,600 LBS	▶ EXT WIDTH: 8 FT 6 IN
▶ GCWR: 46,600 LBS	▶ FRESH/GRAY/BLACK: 105/75/50 GAL
▶ MSRP: \$516,266	

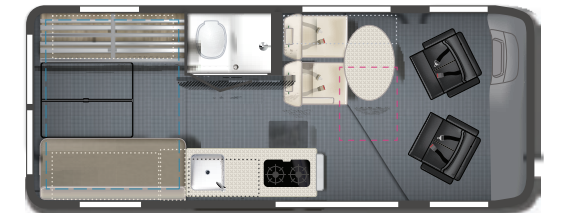

WINNEBAGO SOLIS POCKET 36B

Why We Heart This:

The Solis Pocket has all the modes. A dinette mode and a travel mode. A sleep mode and four different lounge modes. So you're not just getting new views outside—you're also getting new views in your cabin. Then there's the option to get the exclusive EcoFlow Power Kit Pro, which optimizes energy efficiency (see Page 41) by replacing your inverter, shore power converter, battery energy converter, solar energy converter, and alternator energy optimizer with a single system.

See more at [Winnebago.com](https://www.winnebago.com).

Specs:

▶ CHASSIS: RAM PROMASTER 280HP	▶ EXT LENGTH: 17 FT 10 IN
▶ ENGINE: 3.6L V6 GAS	▶ EXT HEIGHT: 9 FT 5 IN
▶ GVWR: 8,550 LBS	▶ EXT WIDTH: 6 FT 9 IN
▶ GCWR: 12,000 LBS	▶ FRESH/GRAY/BLACK 20/20/5.5 GAL
▶ MSRP: \$140,375	



THOR MOTOR COACH ARIA 340I

Why We Heart This:

The Aria is a diesel pusher that stands-alone in a crowd. Beyond its stunning good looks—seriously, look at that Salt Rock body paint—the features in the interior are what truly sing. Electric induction cooktops. An over-the-range convection microwave. That beautiful backsplash. The kitchen hits all the right notes. But the crescendo comes in the bedroom—with a king-sized Tilt-A-View inclining bed that's surrounded by a chorus of closet space.

See more at [ThorMotorCoach.com](https://www.thormotorcoach.com).

Specs:

▶ CHASSIS: FREIGHTLINER XC-R	▶ EXT LENGTH: 34 FT 9 IN
▶ ENGINE: CUMMINS ISB-XT 6.7L 360HP	▶ EXT HEIGHT: 12 FT 6 IN
▶ GVWR: 32,400 LBS	▶ EXT WIDTH: 8 FT 5 IN
▶ GCWR: 42,400 LBS	▶ FRESH/GRAY/BLACK 91/51/51 GAL
▶ MSRP: \$394,350	

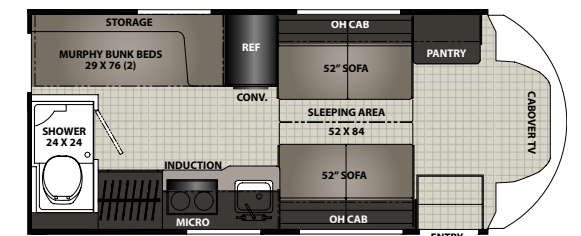

COACHMEN CROSS TRAIL EV 20BH

Why We Heart This:

Who doesn't love an RV that does things folks say can't be done? Operating your AC off of battery power is one of those no-nos that the Cross Trail EV simply laughs at. With its Renogy-empowered-state-of-art-hybrid electrical system, you can kiss your generator goodbye and enjoy power in silence. Nature likes that (Page 27), and so do we.

See more at [CoachmenRV.com](https://www.coachmenrv.com).

Specs:

▶ CHASSIS: FORD TRANSIT	▶ EXT LENGTH: 24 FT 1 IN
▶ ENGINE: 3.5L ECOBOOST	▶ EXT HEIGHT: 10 FT 6 IN
▶ GVWR: 11,000 LBS	▶ EXT WIDTH: 7 FT 7 IN
▶ GCWR: 15,000 LBS	▶ FRESH/GRAY/BLACK 25/31/31 GAL
▶ MSRP: \$155,368	

Photos courtesy of respective manufacturers

Photos courtesy of respective manufacturers



CLASS C MODELS AND FIFTH WHEELS

Information provided for entertainment purposes only and not guaranteed accurate. For up-to-date specifications on all RV models, please contact each respective manufacturer directly prior to making any purchase decisions.



JAYCO GREYHAWK XL 32U

Why We Heart This:

Rugged roads lead to the best parking spots, and this Super C by Jayco gives you the off-road handling to get there. Ford AdvanceTrac with RSC (roll stability control) and trailer sway control improves your ability to negotiate every driving surface—right from the cockpit of a luxury rig. Jayco seems to think you can have real power and rugged handling at no cost to comfort. List the Greyhawk XL as hard evidence.

See more at [Jayco.com](https://www.jayco.com).

Specs:

▶ CHASSIS: FORD F550 4X4	▶ EXT LENGTH: 34 FT 2 IN
▶ ENGINE: 6.7L POWER STROKE V8 TURBO DIESEL 330 HP	▶ EXT HEIGHT: 12 FT
▶ GVWR: 19,500 LBS	▶ EXT WIDTH: 8 FT 5 IN
▶ GCWR: 31,500 LBS	▶ FRESH/GRAY/BLACK: 42.5/31/31 GAL
▶ MSRP: \$256,800	



JAYCO EAGLE HT FW 26REC

Why We Heart This:

Sure there are bigger—and more expensive—fifth wheels. But it's hard not to be content with everything we see in the Eagle 26REC. This half-ton has a spacious interior with stylish décor that is fresh, easy, and modern, complete with GE appliances. Outside, a 22-inch griddle is ready for action. And underneath? A four-star handling package with TPMS monitoring. So yes, it's lighter and more affordable. And yes, it's still Jayco.

See more at [Jayco.com](https://www.jayco.com).

Specs:

▶ LENGTH: 29 FT 5 IN	▶ HITCH WEIGHT: 1,615 LBS
▶ HEIGHT: 12 FT 4 IN	▶ FRESH/GRAY/BLACK: 52/82/45 GAL
▶ DRY WEIGHT: 8,055 LBS	▶ MSRP: \$51,006



IT'S YOUR ADVENTURE.
BRING IT.

Exclusive options. Built to order.

DESIGN YOURS:
[KINGSTAR.NET/ADVENTURE](https://www.kingstar.net/adventure)

CALL:
480-686-1302 or 906-275-5000

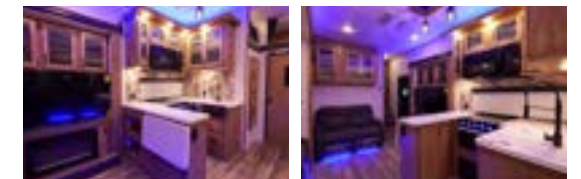

FOREST RIVER CHEROKEE WOLF PACK DIAMOND 4500

Why We Heart This:

It feels like Forest River just said yes to everything—and we're so glad they did! The Wolf Pack Diamond 4500 is a long drink of water. It has two fireplaces, two awnings, three slides, a 14-foot-long garage, and a ramp door patio deck. Not only that, in a matter of minutes, this fully featured toy hauler converts into a bunkhouse. So you can bring your whole wolf pack along, pups and all.

See more at [ForestRiverInc.com](https://www.ForestRiverInc.com).

Specs:

▶ LENGTH: 45 FT 3 IN	▶ HITCH WEIGHT: 3,305 LBS
▶ HEIGHT: 13 FT 5 IN	▶ FRESH/GRAY/BLACK: 96/88/88 GAL
▶ DRY WEIGHT: 13,958 LBS	▶ MSRP: \$140,909

Photos courtesy of respective manufacturers



FIFTH WHEELS, TOY HAULERS AND TRAVEL TRAILERS

Information provided for entertainment purposes only and not guaranteed accurate. For up-to-date specifications on all RV models, please contact each respective manufacturer directly prior to making any purchase decisions.



EAST TO WEST BLACKTHORN 22RK

Why We Heart This:

Hard to say how excited we are about the debut of the Blackthorn, but we can sum it up in a word: VERY. While the name comes from a flower found in folklore, the sharp lines of its exterior are strikingly modern. But, as the Old World would remind us, true beauty lies within. This mid-profile fifth wheel is no exception with solid wood Shaker-style cabinet doors, a high-rise kitchen faucet, and motion-sensor ceiling lights.

See more at EastToWestRV.com.

Specs:

▶ LENGTH: 26 FT 11 IN	▶ HITCH WEIGHT: 1,200 LBS
▶ HEIGHT: 11 FT 11 IN	▶ FRESH/GRAY/BLACK: 64/88/44 GAL
▶ DRY WEIGHT: 7,250 LBS	▶ MSRP: \$63,298



INTECH TERRA MAGNOLIA

Why We Heart This:

For those mostly familiar with the rugged-but-handsome look of inTech's adventure trailers (like the O-V-R), the smooth, glossy lines of the Terra Magnolia will come as something of a shock. (The good kind.) From the large farmhouse-style sink to the massive panoramic windshield that arcs around the dinette, every interior feature seems designed to welcome, giving you a sense of extravagant quality across each square inch while never feeling crowded.

See more at inTech.com.

Specs:

▶ LENGTH: 22 FT 6 IN	▶ GVWR: 7,500 LBS
▶ HEIGHT: 10 FT 4 IN	▶ FRESH/GRAY/BLACK: 44/30/26 GAL
▶ DRY WEIGHT: 4,764-5,200 LBS	▶ MSRP: \$61,600



BRINKLEY MODEL G TOY HAULER 3500

Why We Heart This:

Just two seconds in the Model G's kitchen, and you'll say, "Dang! If they didn't think of everything!" Brinkley RV really brought its A-game. We're talking slide-out spice racks, pull-down utensil trays, magnetic knife drawers, and an island that extends into a peninsula for extra surface space and seating. The 11-foot garage isn't even worthy of the name—it's so beautiful (with three-season patio doors) and innovative (with a Happijac sofa and bed-lift system).

See more at BrinkleyRV.com.

Specs:

▶ LENGTH: 40 FT 2 IN	▶ HITCH WEIGHT: 3,320 LBS
▶ HEIGHT: 13 FT 5 IN	▶ FRESH/GRAY/BLACK: 150/104/104 GAL
▶ DRY WEIGHT: 16,967 LBS	▶ MSRP: \$185,610



CORTES CAMPERS CORTES 16 TRAILER

Why We Heart This:

If the future is made of fiberglass, we sure hope it looks exactly like the Cortes 16—an ingenious camper without wood or any material that can rot. The 2024 layout reorients the king-sized bed lengthways and economically converts it into a dinette by day. On the outside, the Cortes 16 is equally customizable, giving you a multitude of color options—ranging from the classic two-tone look to solid and metallic flake options.

See more at CortesCampers.com.

Specs:

▶ LENGTH: 18 FT 2 IN	▶ DRY WEIGHT: 2,200 LBS
▶ WIDTH: 6 FT 8 IN	▶ GVWR: 3,500 LBS
▶ HEIGHT: 8 FT 2 IN	▶ FRESH/GRAY/BLACK: 21/13/16 GAL
▶ MSRP: COMING SOON	

Photos courtesy of respective manufacturers

Photos courtesy of respective manufacturers



COMPACT TRAVEL TRAILERS AND TEARDROPS



HAPPIER CAMPER HC1 BREEZE

Why We Heart This:

Happier Camper has mastered the improbable in giving us a distinctly modern camper with a stylish vintage feel that can—wait for it—be towed by most cars. But that's only the start of what makes HC1 Breeze so cool. Adaptiv's modular interior provides a revolutionary array of options for cabin design. And, achieving the improbable once more, it can sleep five with a bunk or mega bed.

See more at HappierCamper.com.

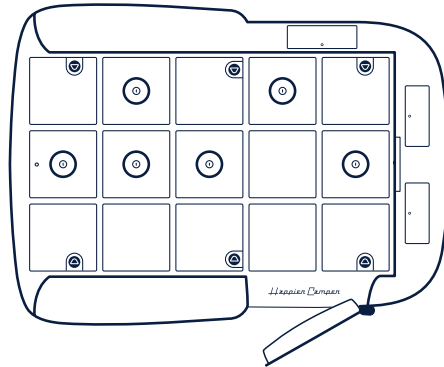

Specs:

▶ LENGTH 13 FT 5 IN	▶ GVWR 3,500 LBS
▶ WIDTH 7 FT 1 IN	▶ FRESH/GRAY 3/3 GAL
▶ HEIGHT 7 FT 8 IN	▶ MSRP: \$24,950



LITTLE GUY MAX ECO-1

Why We Heart This:

RV life is all about choosing what matters most and making it count. That's what makes the Max Eco-1 awesome. This teardrop is all about comfort, storage, and electronics. Its warm hardwood interior makes the cabin feel like ... a cabin. There's maple cabinetry, a full-height pantry, plenty of wardrobe space, and a queen-size master bed with a 24-inch TV. Bluetooth connectivity pulses throughout with three-zone audio output and exterior speakers.

See more at GoLittleGuy.com.



Specs:

▶ LENGTH: 21 FT	▶ GVWR: 4,000-4,200 LBS
▶ WIDTH: 7 FT	▶ FRESH/GRAY/BLACK: 19-20/25-30/9 GAL
▶ HEIGHT: 9 FT 7 IN	▶ MSRP: \$33,740

What?! That's not enough new RVs for you? (We get that.) See these and more 2024 RVs coming down the pike.



Photos courtesy of respective manufacturers

CONTINUUM™ WEIGHT DISTRIBUTION HITCH

The whole point of a weight distribution hitch is getting the correct amount of weight moved from the rear axles to the front axles of your vehicle. Current weight distribution hitches take an all-or-nothing approach: loaded or unloaded. Our composite LITEFLEX® bars make it possible to fine-tune your setup with just the pump of a handle.

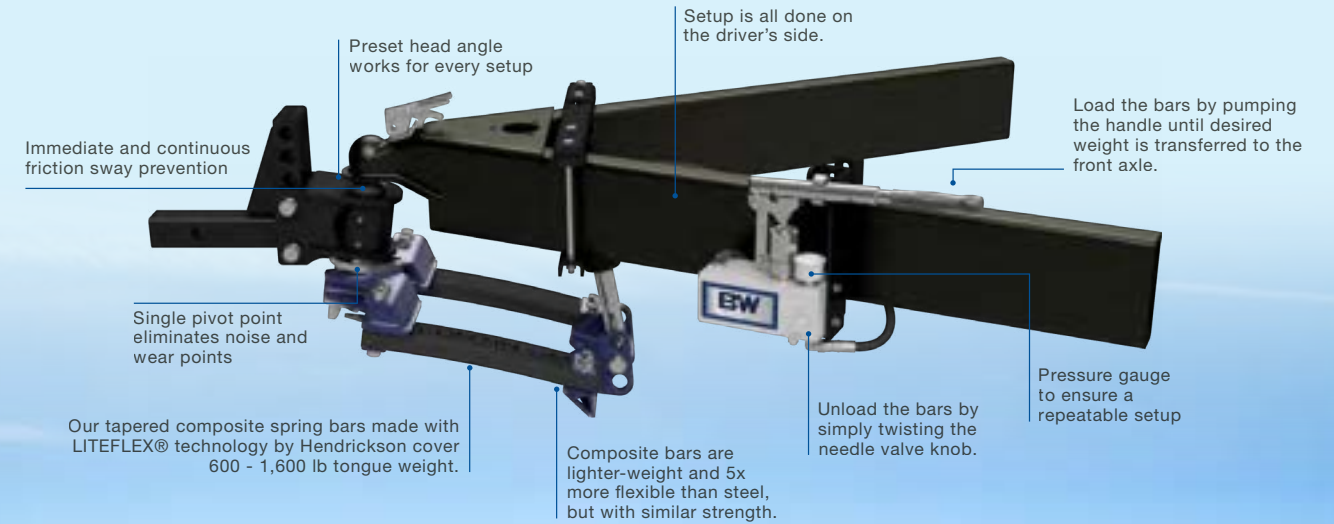

RV MARKETPLACE

Major RV Innovation
CloZures Shade

Operate without opening the screen or entry door.



Enjoy outside view, control privacy, temp, and light with just a finger slide.

zarcor.com

972-380-8724 | 800-877-4797

SULASTIC
RUBBER SPRINGS

SMOOTHER RIDE
by just replacing the shackle

- Same payload & towing capabilities
- Keeps the ride height in the 1/4" range (unloaded)

www.sulastic.com
(210) 492-4469

ADVERTISE HERE!

Contact Kim Whitaker for ad sizes and rates. Kim@IHeartRVing.com

(919) 412-6325

Stargazer 12-Inch Cast Iron Skillet *By Nate Kennedy*

THIS CAST IRON IS WORTH ITS HEFTY PRICE. WE PUT IT OVER THE COALS, AND IT SIZZLED. AMAZING CAMPFIRE FLAVORS AND AN EASY CLEANUP.

BOTTOM LINE UP FRONT:

➔ **THE RIGHT TOOL** makes outdoor cooking—one of our favorite RV activities—even better. Eggs and bacon (we love you, too, sausage!) in the morning? Or a bone-in ribeye slapped in butter over the coals for dinner? The Stargazer 12-inch skillet shatters every expectation. You can sauté some asparagus too (in the bacon grease). The curved shape of the handle disperses heat to keep it cool and holdable way longer than seems safe. Even with its large 12-inch size, the weight is perfectly balanced so you can comfortably be the boss of whatever you're cooking for the family, especially if you've got a grip on the helper handle.

FEATURES WE LOVE:

Stay-Cool Handles

The dual connection points on both the primary and helper handles allow heat to escape. Add the curved shape of the handle for balance and heat dispersion, and you can hold on ... well, till you can't.

Drip-Free Flared Rim

Stargazer has done away with the traditional pour spout and introduced a drip-free flared rim, which means clean pouring from any angle. So, less spillage—cause you don't wanna lose a drop of flavor.

Ideal Dimensions

Here are the deets: rim diameter, 12 inches; cooking surface diameter, 9.4 inches; length, 21.5 inches; height, 3.5 inches; depth, 2.3 inches; capacity, 3.4 quarts or 13.8 cups; weight, 6.5 pounds.

**American-Made, Baby!**

It's made in Lehigh Valley, Pennsylvania, cast as one piece, with the cooking surface machined smooth for a true non-stick pan. Buy preseasoned or bare—to season with your own special style.

Enjoy Camp Cooking at Its Best
Buy at StargazerCastIron.com.

MSRP: \$145.00

WATCH NATE'S SIZZLE REEL.

See our full review on YouTube.



Photo courtesy Stargazer

Firesides

FINAL TOASTS AND LAST ROASTS FOR THE ROAD

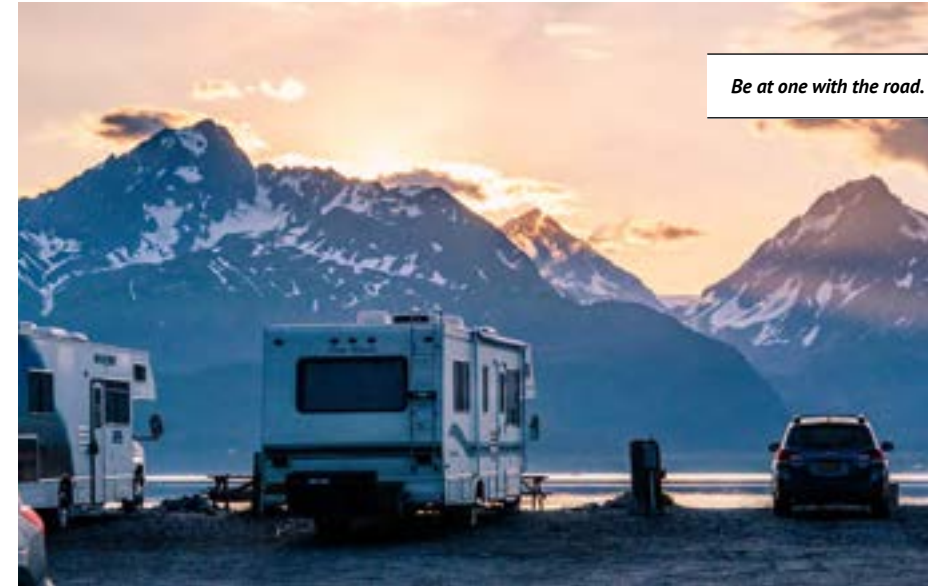

Be at one with the road.

One Last Moment of Zen

WHEREVER YOU GO, THERE YOU SHOULD BE.

1 LAST LAUGH

(The Daddest Joke Around)

What do you call an RV factory that builds units that are just OK?

A satisfactory.

1 FINAL INSPIRATION

(Deep Thoughts)

"The world is a book, and those who do not travel read only one page." – St. Augustine

"The world is not in your books and maps, it's out there." – Gandalf in The Hobbit, by J.R.R. Tolkien

1 SIMPLE TIP

(Bag It, Don't Box It)

Boxes are infinitely more stackable, but plastic bags waste zero

square inches of space, and conform to whatever shape your storage space takes. You might already be using this method in the kitchen (preferably with the Bee's Wrap we mentioned in our eco-friendly feature on Page 27), but clothes are another great option for bagging, especially if you have a vacuum sealer. Vacuum packed clothes take up to 80 percent less room.

1 BIG TEASE

(Let's Go Somewhere Hot and Sandy)

Next issue we turn our gaze southward to Florida, where we'll take in all things beachy and beautiful. We'll also take a romp through time to explore what makes those retro RVs so dang cool. Got a favorite beach spot we should visit? Send it to editorial@IHeartRVing.com!



1 FORMAL INVITATION

(Just for You)

Join us on Facebook at @IHeartRVing
Join us on Instagram at @IHeartRVing
Join our email list at IHeartRVing.com
Subscribe to IHeartRVing on YouTube

1 CLOSING WORD

(Go)

Here's another quote: "It's not the critic who counts ... The credit belongs to the man who is actually in the arena." We think, perhaps, it belongs to the man who is out on the open road. It's not a coincidence that Teddy Roosevelt, to whom this quote belongs, was one of America's most important conservationists. We think that had he lived till today, he would have been an avid subscriber. (But man, he'd be old.)

Got somebody that reminds you of Teddy? Use this QR code and share us with your favorite road buddy!

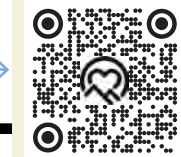

RV MARKETPLACE

Hinlo Bowl

Clean Touchdown Every Time!

- An eco-friendly, biodegradable, dissolvable & flushable toilet bowl liner
- Designed to be placed inside the toilet bowl (for homes, offices & RVs)
- Prevents human waste from leaving stains behind and preventing splash-back
- Saves time (from cleaning) and water

For a clean, sanitary, hygienic & pleasant pooping experience.

Available on Amazon, HinloBowl.com, & Walmart.com.

CLASSIFIEDS

RVs Wanted



RVBUYERSUSA

WE BUY YEAR 2015-2022 DIESEL & GAS - CLASS A, B, AND C'S
FREE NATIONWIDE PICKUP
FREE APPRAISAL
email: RVBuyers@gmail.com
www.RVBuyersUSA.com
WE WILL BEAT ANY DEALER PRICE

Want to add your business to our classifieds?

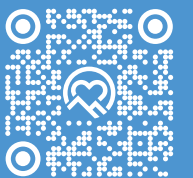

Contact Kim Whitaker
Kim@IHeartRVing.com
(919) 412-6325



ACROSS

- 1. Tidily kept
- 5. Stead
- 8. Prefix, one
- 10. Sewing case
- 11. Pen
- 12. Primate
- 14. Play division
- 15. Plant science
- 16. Reverberate
- 18. Capital of Yemen
- 19. Blotted
- 21. Maturing agent
- 22. Ward off
- 24. To exist
- 25. Expression of disgust
- 26. Part of the verb "to be"
- 28. Citrus fruit
- 31. Pleasant
- 35. Dropsy
- 36. Large tree
- 37. Cowboy exhibition
- 38. Rid of mystery
- 40. Paradises
- 41. Perform
- 42. The sun
- 44. Similar to
- 46. Plays truant
- 47. Sense
- 49. Mew
- 52. Glass bottle
- 55. Indian currency
- 56. Thinly
- 58. Took a seat
- 60. Room within a harem
- 61. Malay dagger
- 62. Narcotics agent
- 63. Abstract being
- 64. Turkish governors
- 65. Value

DOWN

- 1. New Zealand parrots
- 2. Etcetera
- 3. Silent
- 4. The ratio between circumference and diameter
- 5. Unit of capacity
- 6. Republic in SW Asia
- 7. An age
- 8. Turn upside down (2-3)
- 9. Isthmus
- 11. Portended
- 13. Extinct bird
- 15. Sack
- 17. Masculine pronoun
- 19. Be innate
- 20. Remove unwanted plants
- 21. Mote
- 22. Terrified
- 23. Ovum
- 24. Lost blood
- 26. Assistant
- 27. Frenzied woman
- 29. Brief note
- 30. Capital of the Bahamas
- 31. Loops
- 32. Clumsy person
- 33. Knob-like
- 34. Profit failure
- 39. To clothe
- 43. Marine mammals
- 45. Officiating priest of a mosque
- 46. Blue dye plants
- 47. The end
- 48. Cathedral city
- 50. Prefix meaning not
- 51. Soon
- 52. Alter
- 53. Russian emperor

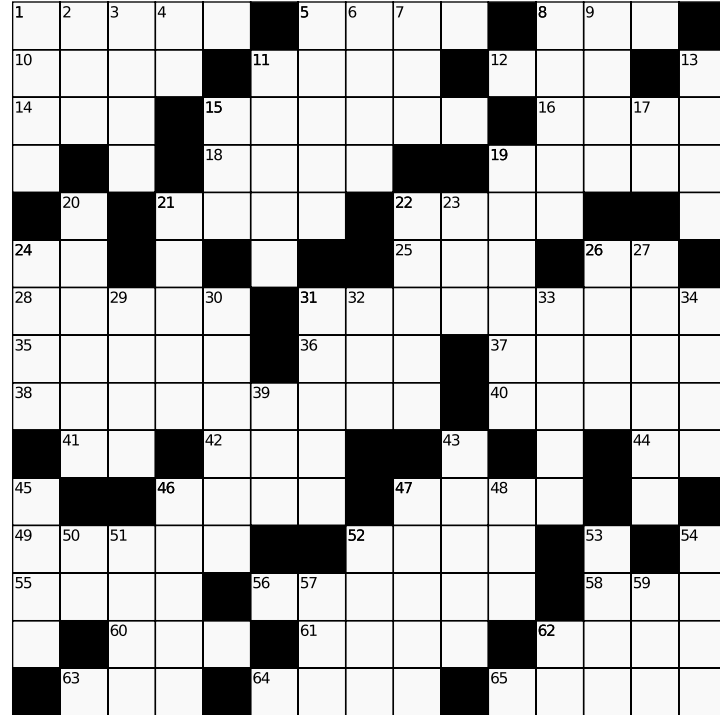

- 54. Engrave with acid
- 57. Supplement existence
- 59. Talent
- 62. Negative note



Alright, kid. Let's see how you did. Scan the QR code and make this thing official.

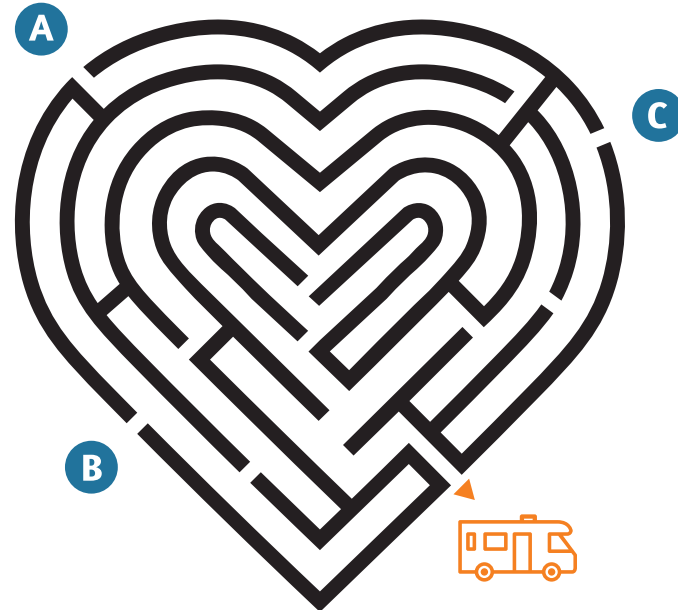
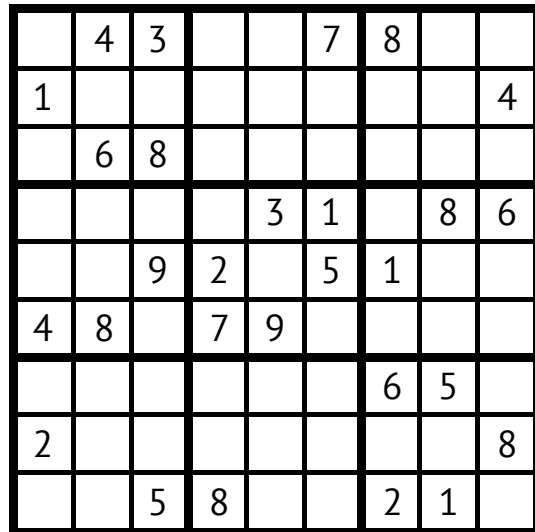

For those whose happy place is just about any place.



Play hard and rest easy in the Momentum series. With its tall ceilings and spacious slide outs, the Momentum has truly raised the bar —and the square footage — when it comes to Toy Haulers. So go ahead, go big — comfortably. *Go where there's more to life.*



MORE OF WHAT MATTERS

WORKSPACE, TECHNOLOGY— AND A VIEW THE BOSS WOULD KILL FOR.



The Corner Office™ exclusively from Fleetwood.

The Corner Office™ turns the affordable Frontier GTX into the ultimate away-from-home office. An L-shaped desk, built-in monitor and plentiful outlets give you the technology, privacy and convenience you need—all in front of a large window. The Frontier GTX also features a spacious floor plan, increased storage and residential-quality appliances, all mounted on the high-performance Freedom Sport Foundation.

Step into The Corner Office, and see the rest of the amazing Fleetwood line-up at [FleetwoodRV.com](https://www.fleetwoodrv.com)



 **FLEETWOOD RV**